

DETAILS

Product Number	FCA12077_IRIS
Family	Iris
Type	Assembly
Color	black
Diameter	38 mm
Height	27,1 mm
Style	round
Optic Material	PMMA
Holder Material	
Fastening	glue, tape, pin, screw
Status	production ready
ROHS Compliant	Yes
Date Updated	3/03/2017



OPTICAL PROPERTIES

LED	Viewing	Light	Effi-	cd/lm	Connector
	Angle	Beam	ciency		
XP-E	4 deg	Real spot	93 %	87.400	-
XP-G	6 deg	Real spot	95 %	-	-
XP-G2	6 deg	Real spot	95 %	46.000	-
XP-E2	5 deg	Real spot	-	103.900	-
XQ-E	sim: 5	Real spot	sim: 93 %	sim: 80.000	-
XHP35 HD	10 deg	Real spot	89 %	18.560	-
XHP35 HI	7,6 deg	Real spot	90 %	35.900	-
XQ-E HI	3,9 deg	Real spot	88 %	123.300	-
XP-G3	sim: 7,7	Real spot	sim: 91 %	sim: 28.700	-
XP-E2	sim: 5,6	Real spot	sim: 94 %	sim: 64.200	-
H35C1 (LEMWA33)	8 deg	Real spot	89 %	40.400	-
LUXEON Rebel	5 deg	Real spot	-	75.600	-
LUXEON Rebel ES	7 deg	Real spot	93 %	38.500	-
LUXEON T	7 deg	Real spot	94 %	40.200	-
LUXEON H50-2	sim: 7	Real spot	-	-	-
LUXEON TX	6.9 deg	Real spot	89 %	43.100	-
LUXEON Z ES	4 deg	Real spot	93 %	94.060	-
NCSxx19A	5 deg	Real spot	-	-	-
NVSxx19A	6 deg	Real spot	93 %	38.700	-
NWSx229A	10 deg	Real spot	91 %	18.600	-
NVSxx19B/NVSxx19C	7 deg	Real spot	92 %	36.600	-
NVSW3x9A	8 deg	Real spot	89 %	26.300	-
Oslon SSL 80	4 deg	Real spot	90 %	89.000	-
Oslon SSL 150	4 deg	Real spot	-	76.800	-
LH351Z	7 deg	Real spot	89 %	48.100	-



PRODUCT DATASHEET

Iris series

last update 3/3/2017

OPTICAL PROPERTIES

LED	Viewing Angle	Light Beam	Effi- ciency	cd/lm	Connector
Z8Y22P	sim: 8	Real spot	sim: 98 %	sim: 29.900-	

Relative intensity of FCA12077-IRIS_(XPE2)

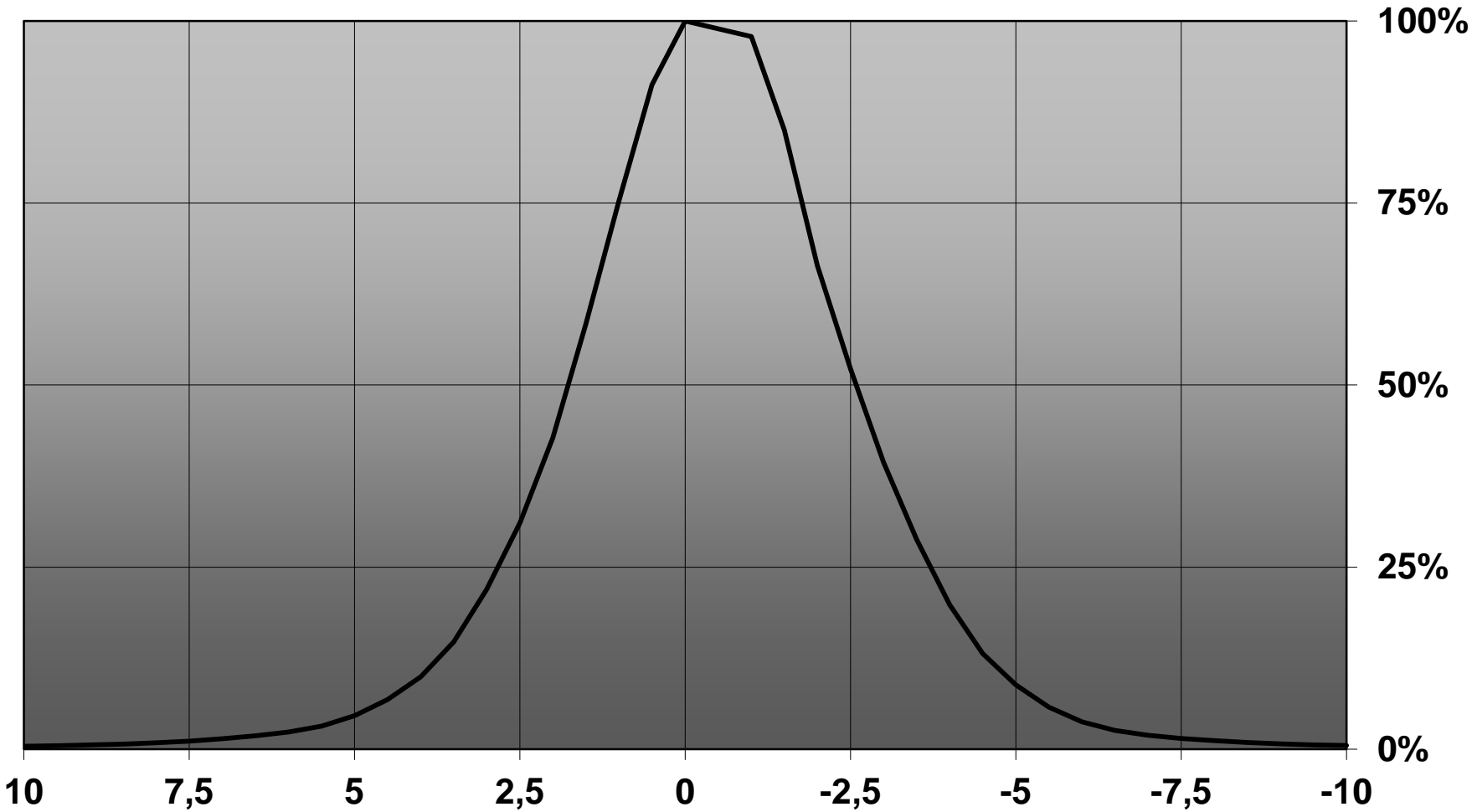

Relative intensity of FCA12077_IRIS_(XHP35_HD)

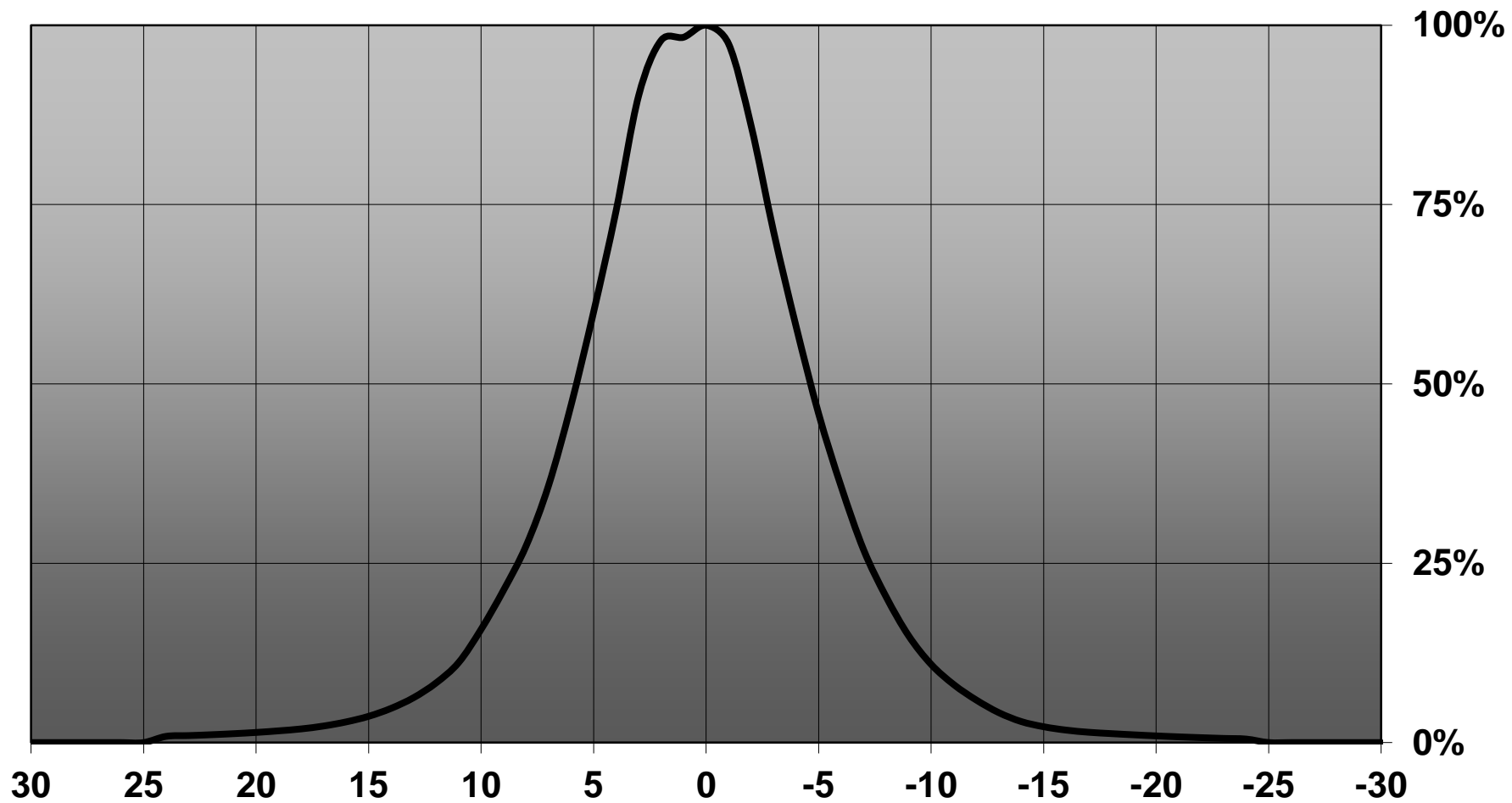

Relative intensity of FCA12077_IRIS_(XPH35_HI)

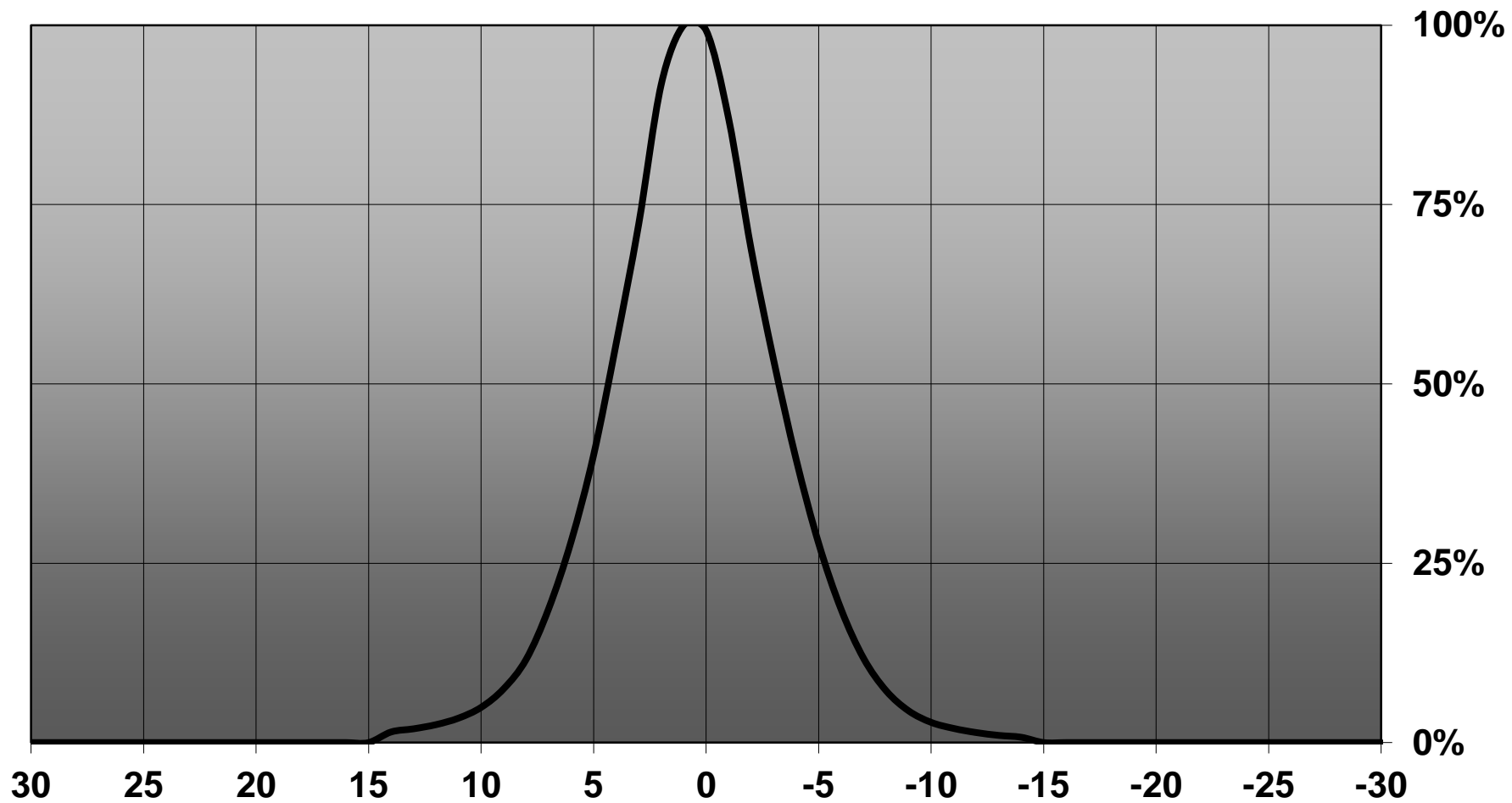

Relative intensity of C4F12077_Iris-RE-tape

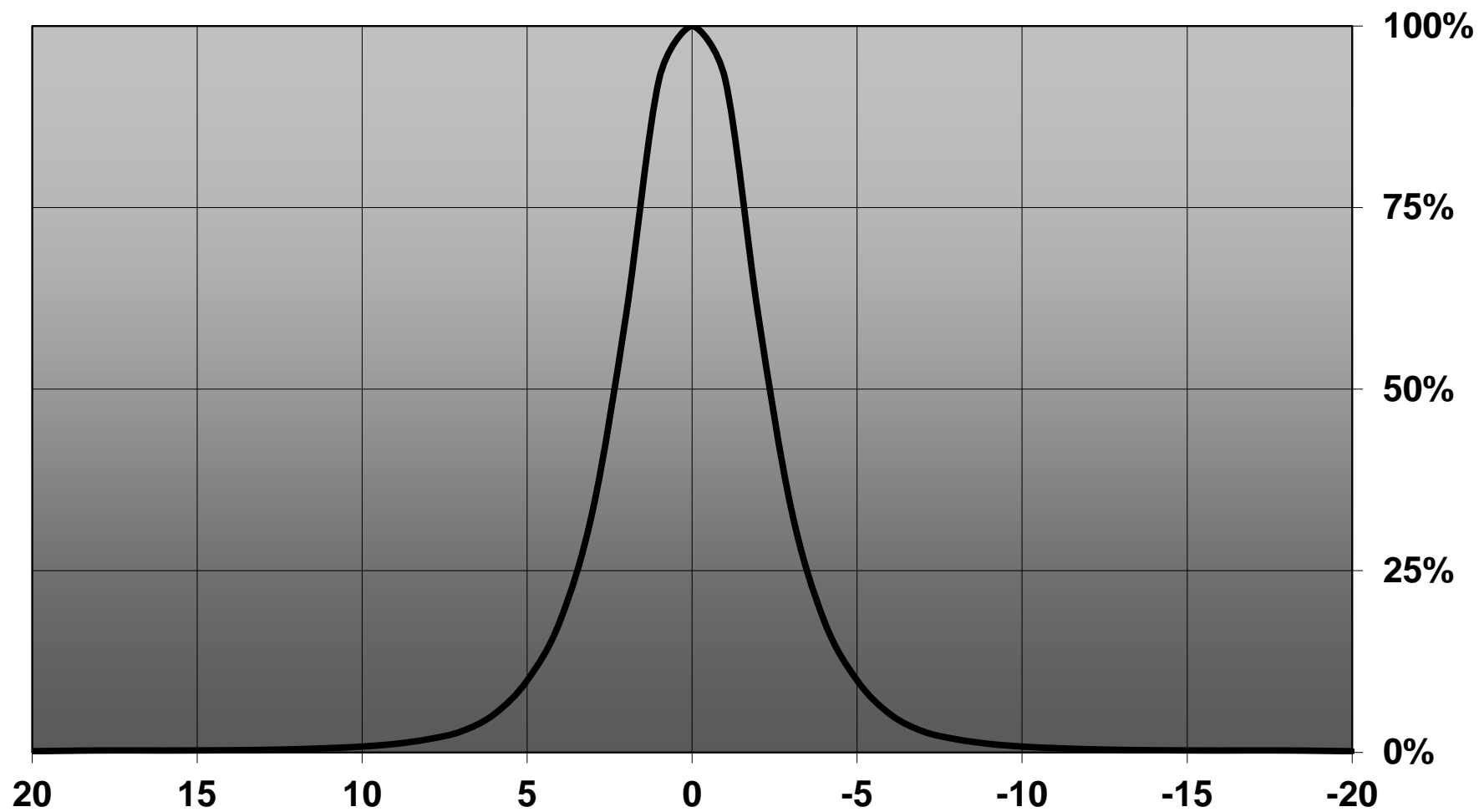

Relative intensity of C4F12077_Iris-RE-ES-tape

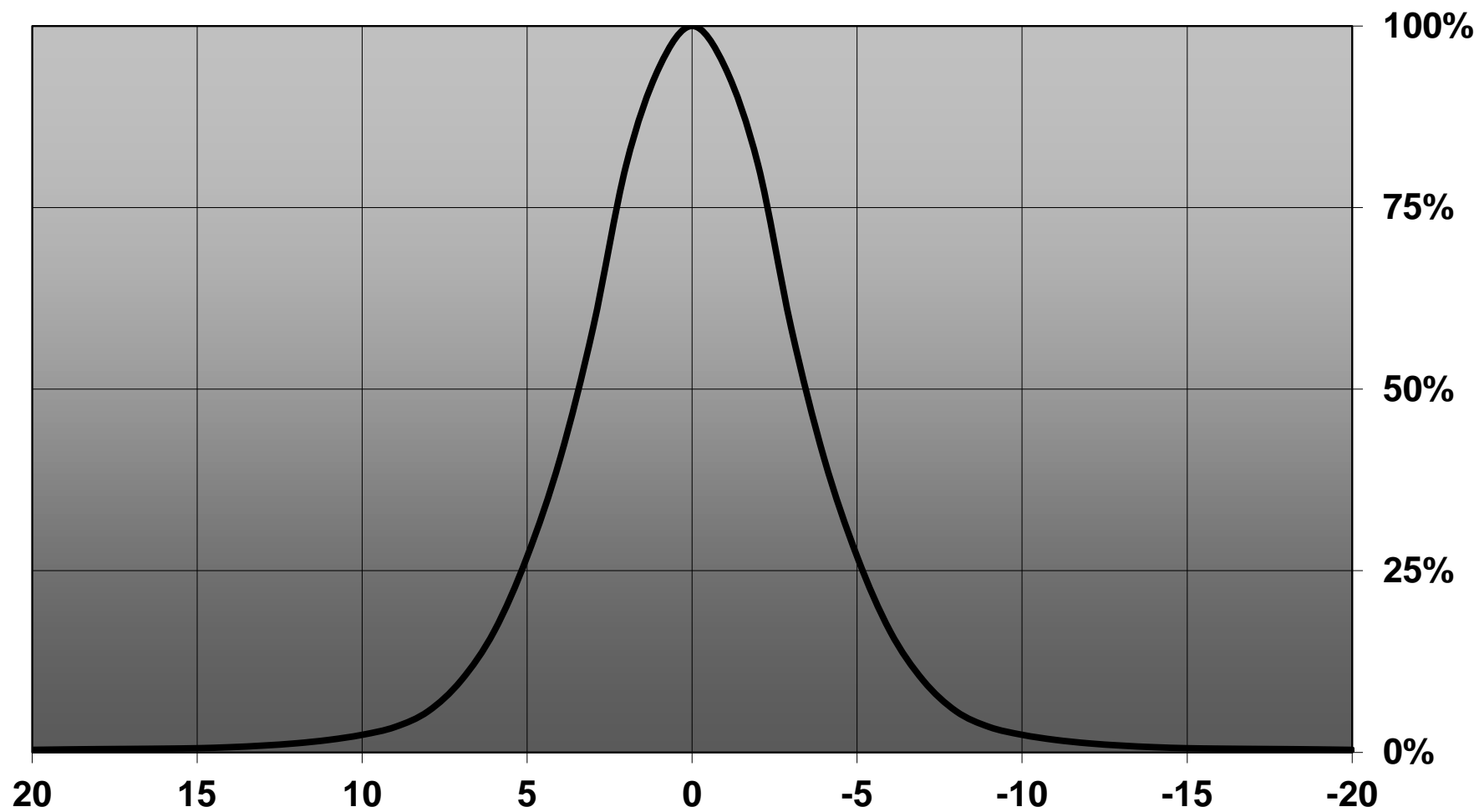

INDEX	PART NO	DESCRIPTION	MATERIAL
1	C10253	Sputnik-tape	PU 2-sided foam tape, adhesive
2	F12075	IRIS lens	PMMA
3	C12202	IRIS-XP-HLD holder	PC, black

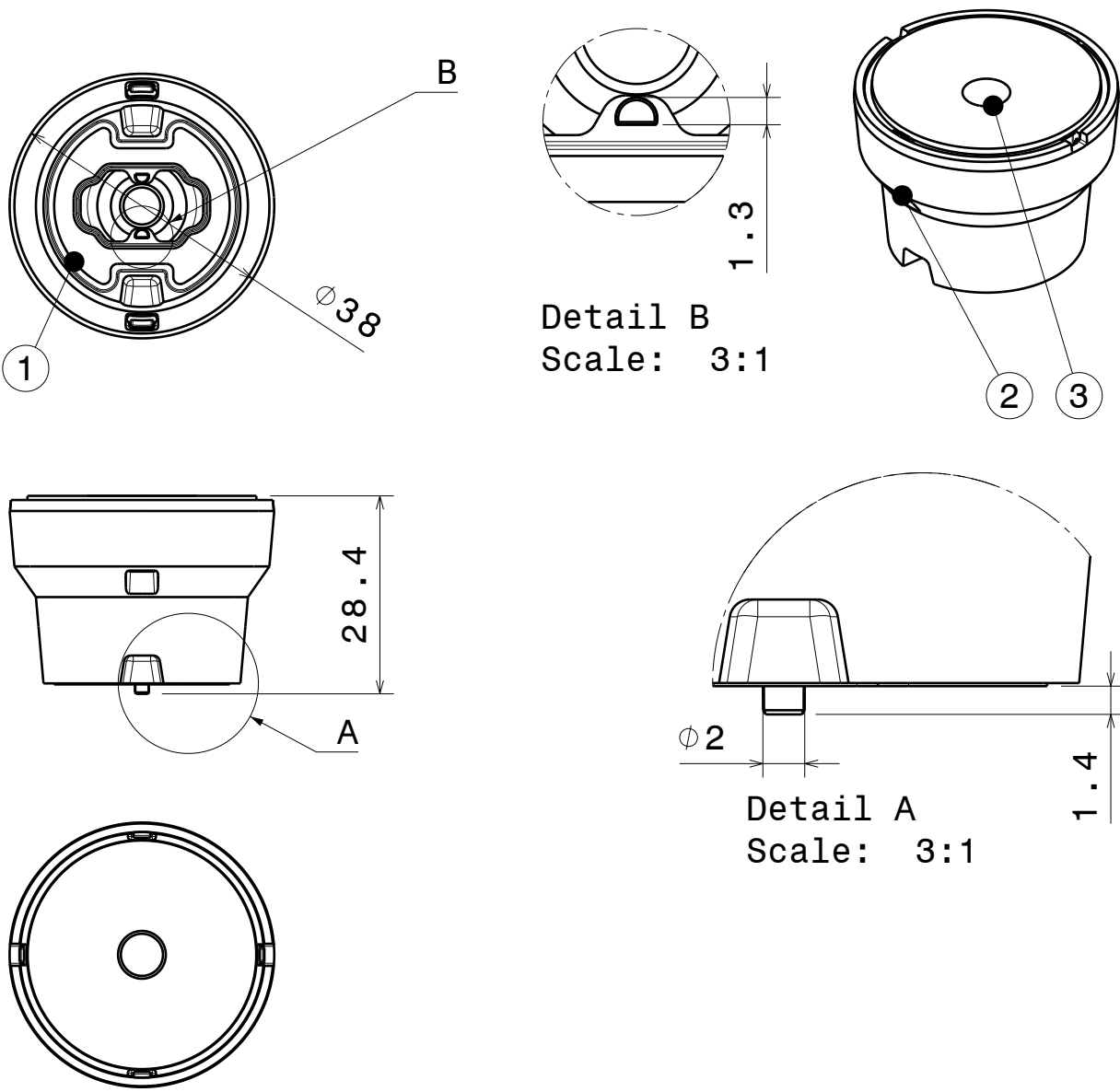

Tolerances for dimensions:
0-20mm tolerance value ±0.1
21-45mm tolerance value ±0.2
46-90mm tolerance value ±0.3
91-100mm tolerance value ±0.4
101-mm tolerance value ±0.5

This drawing is our property.
It can't be reproduced
or communicated without
our written agreement.



Ledil Oy
Salorankatu 10
FIN 24240 SALO
Finland

DRAWING TITLE

Datasheet IRIS

DRAWN BY OHa	DATE 25.5.2012	SIZE A4		DRAWING NUMBER FCA12077		REV 01
CHECKED BY SN	DATE -	SCALE 1:1		WEIGHT (g) 20		SHEET 1/1
DESIGNED BY pv	DATE 25.5.2012					

Valaisin: LEDIL OY FCA12077_IRIS_(XP-G2) Efficiency=95%
Lamput: 1 x Cree XP-G2 (109.1lm @ 250mA)

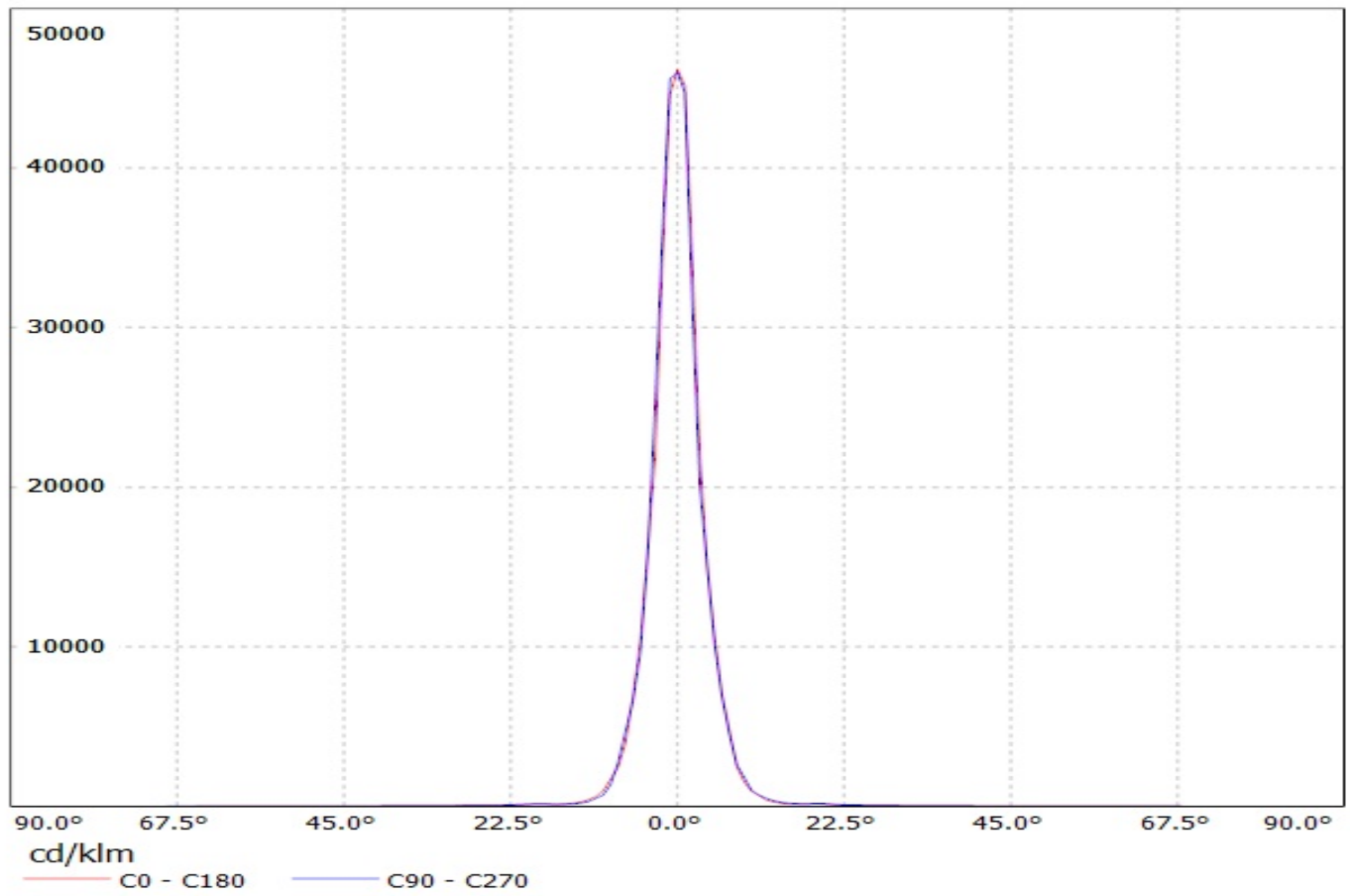

Luminaire: Ledil Oy FCA12077_IRIS_(XHP35_HD)_SIMULATED
Lamps: 1 x Cree XHP35 HD

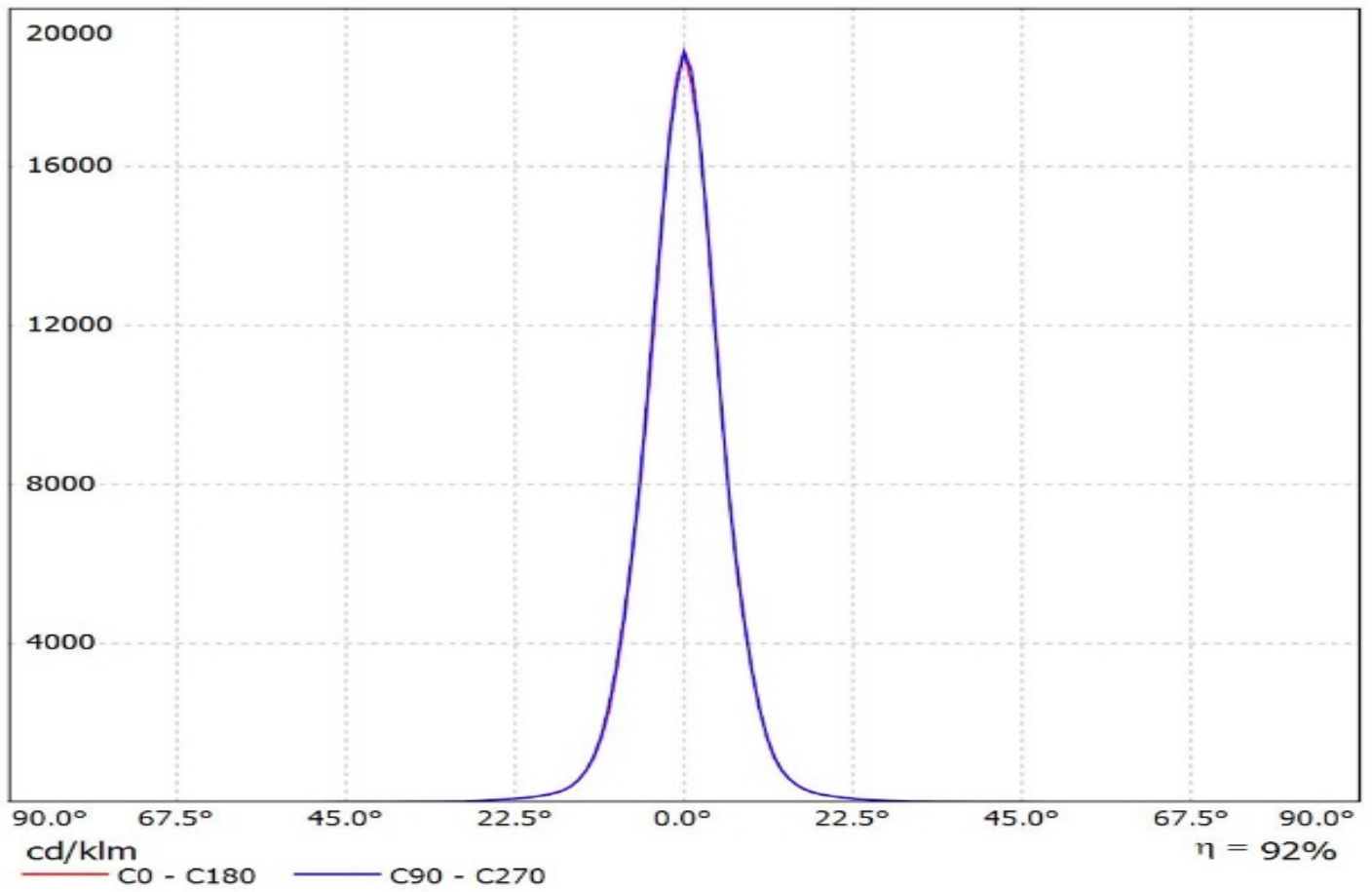

Luminaire: Ledil Oy FCA12077_IRIS_(XHP35_HI)_SIMULATED
Lamps: 1 x Cree XHP35 HI

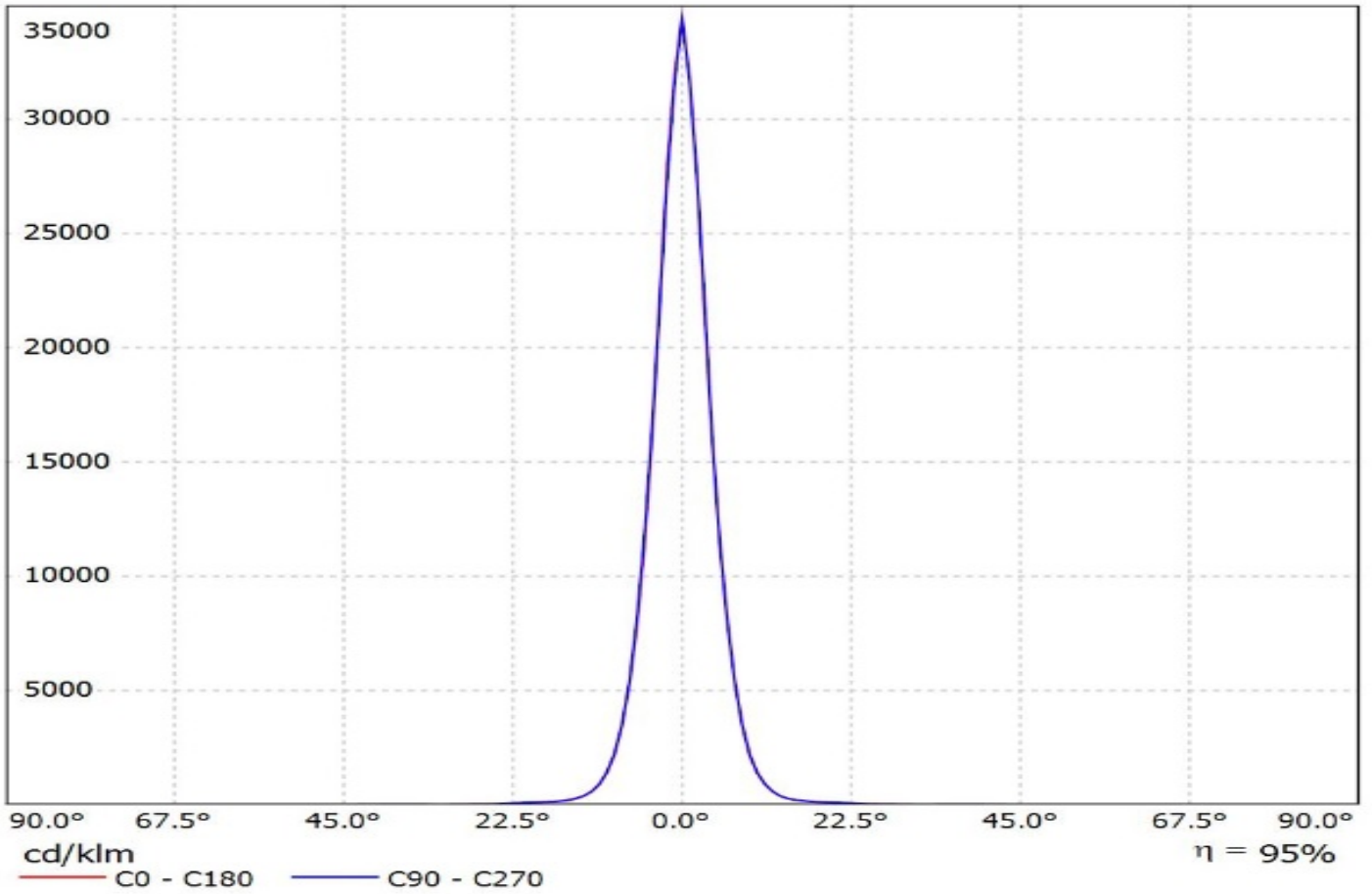

Luminaire: Ledil Oy FCA12077_IRIS_(XQ-E_HI)_SIMULATED
Lamps: 1 x Cree XQ-E HI

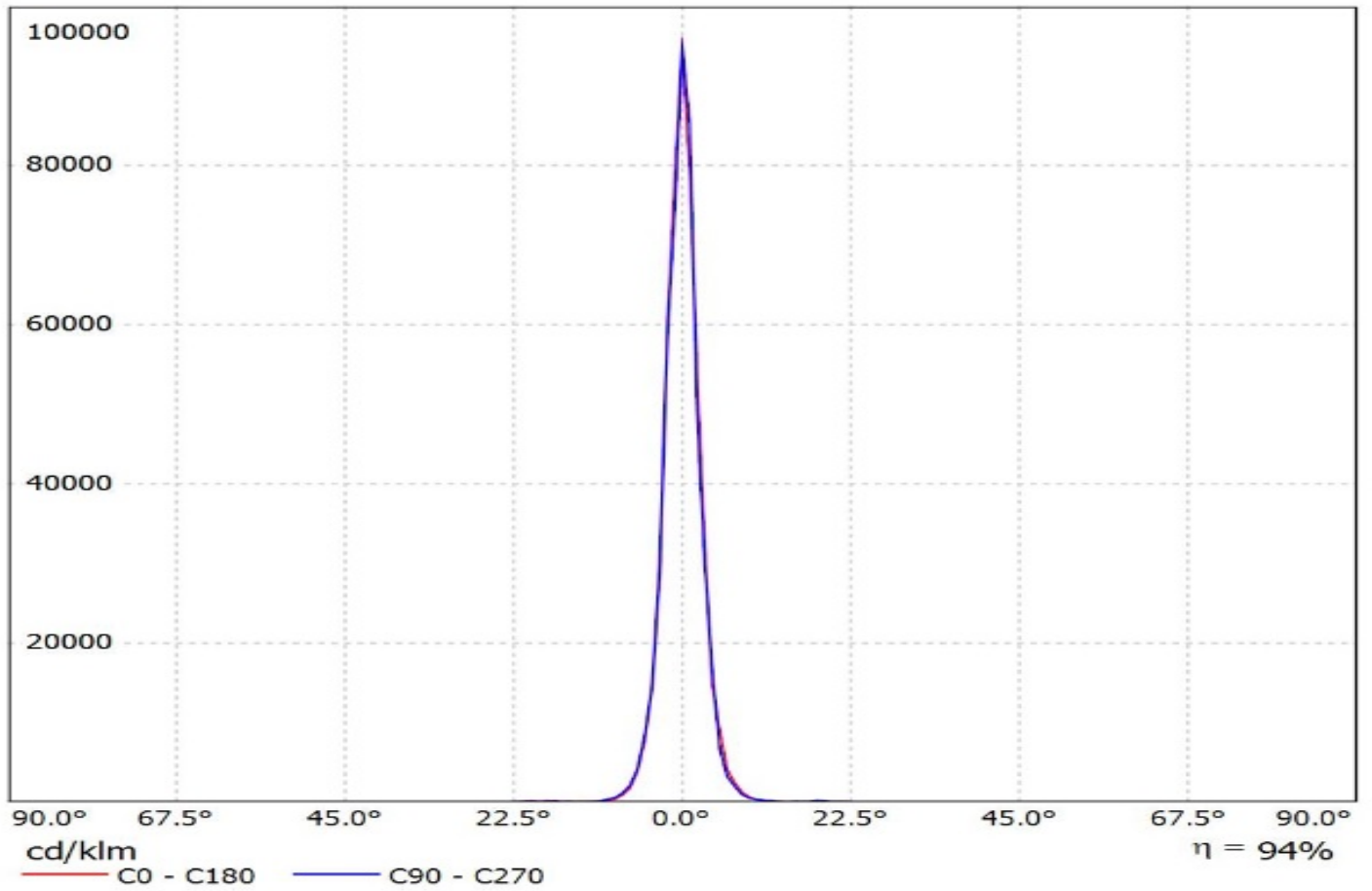

Luminaire: Ledil Oy FCA12077_IRIS_(XP-G3)_SIMULATED
Lamps: 1 x Cree XP-G3

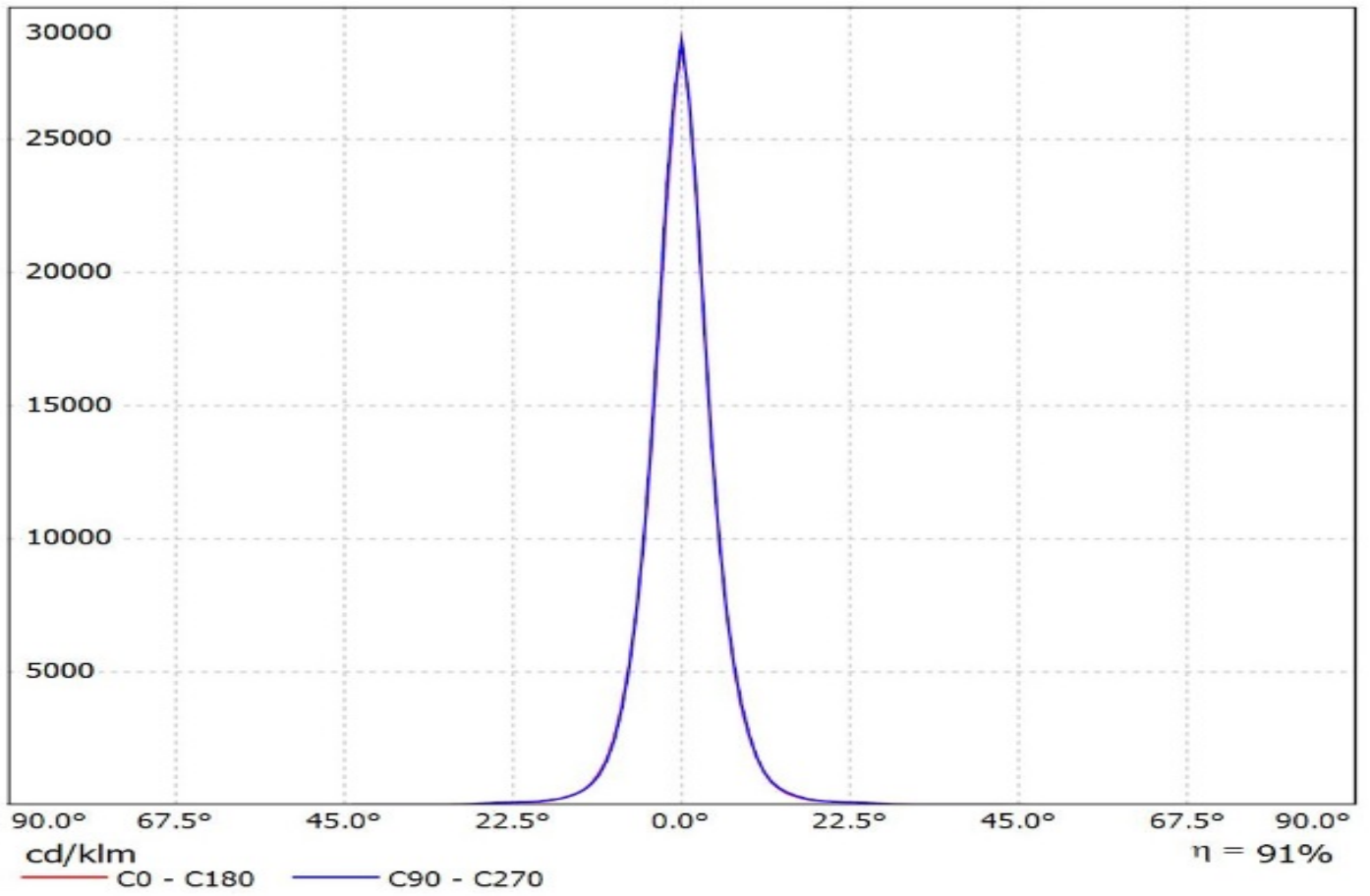

Luminaire: Ledil Oy FCA12077_IRIS_(XP-E2)_SIMULATED
Lamps: 1 x Cree XP-E2

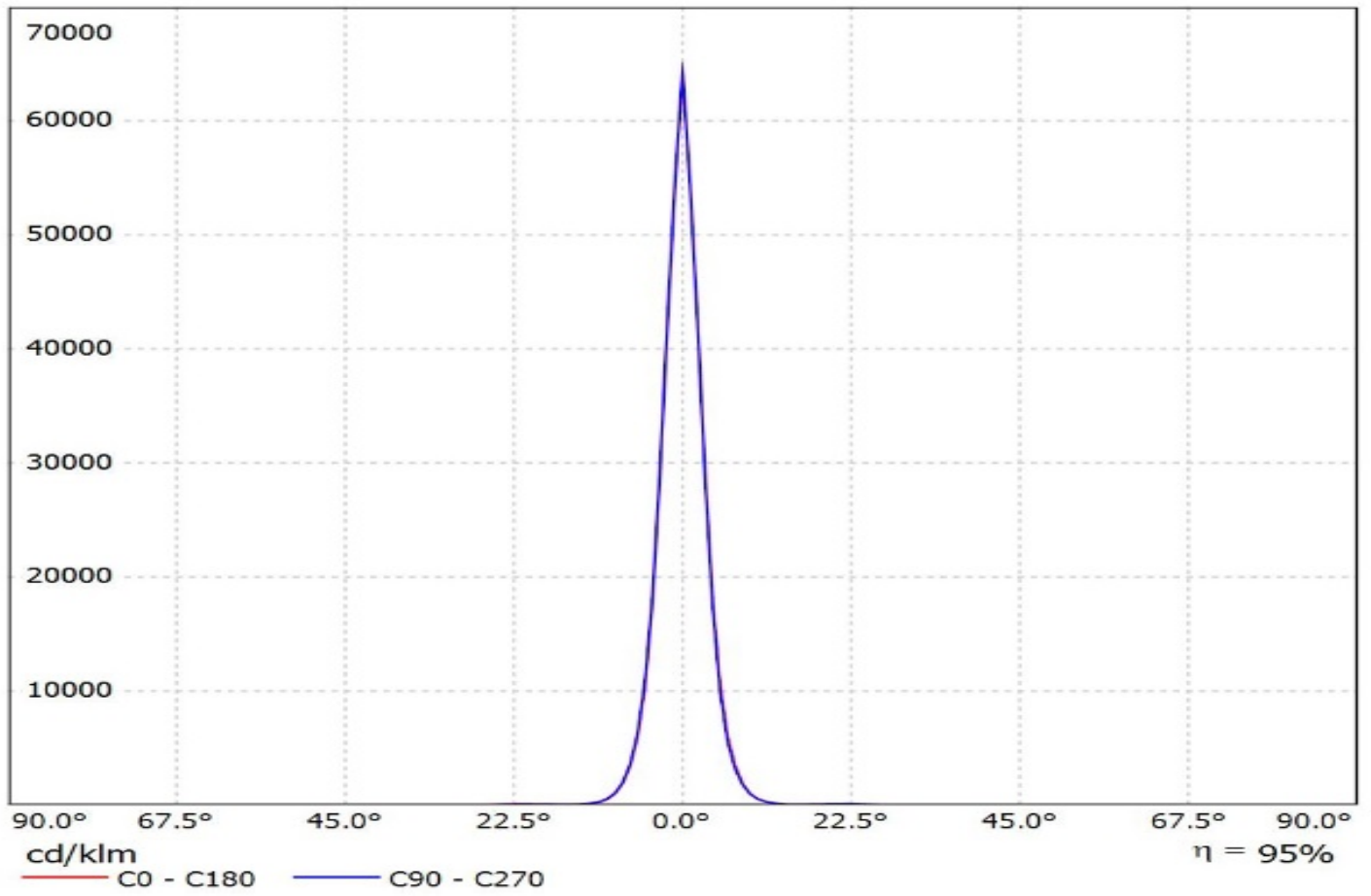

Luminaire: Ledil Oy FCA12077_IRIS_(3535_Ceramic_gen2) Efficiency=89%
Lamps: 1 x LG 3535 Ceramic gen2 (PKG5700k) 116lm @ 250mA CCT=6200k P=0.7 I=250mA

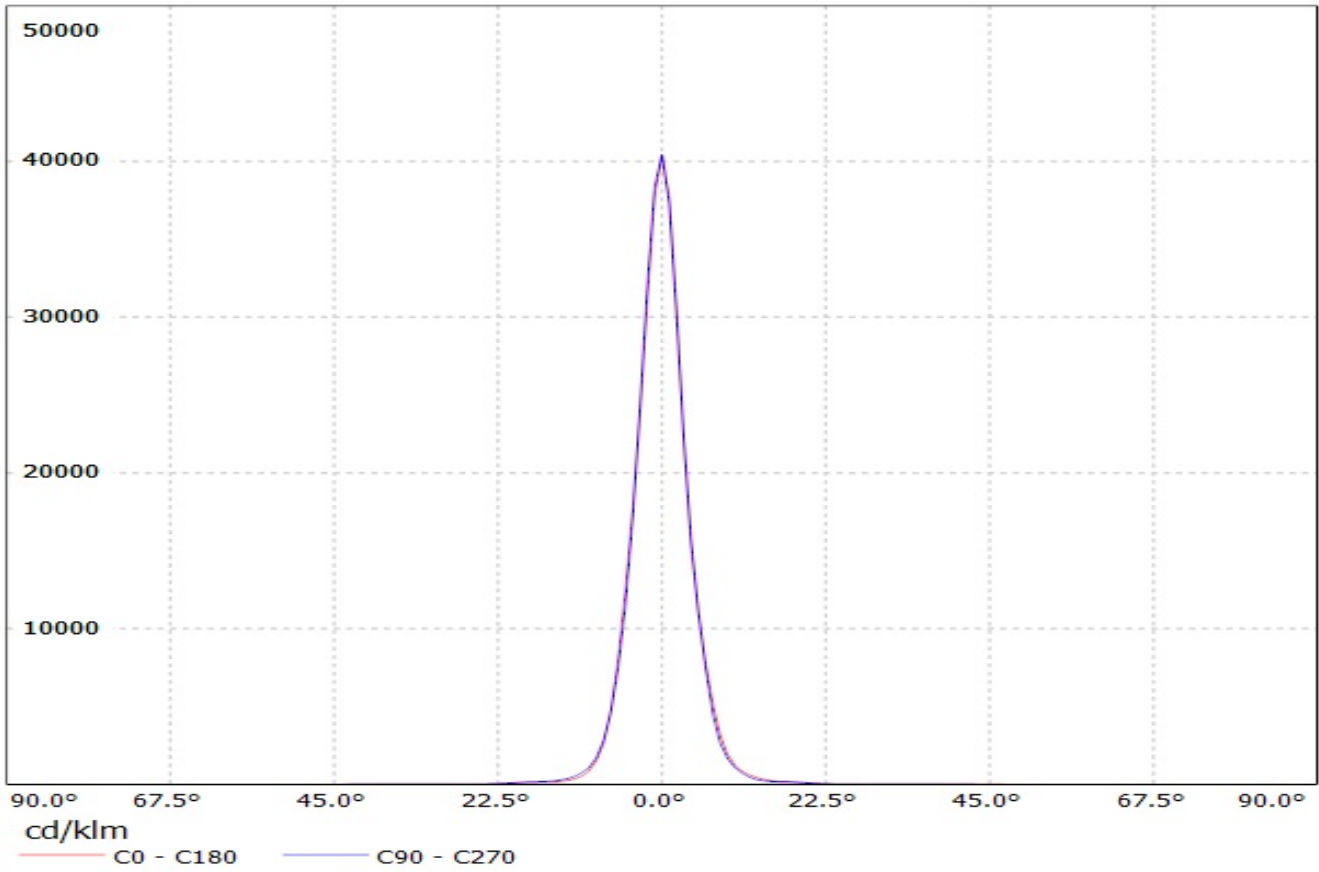

LEDiL Oy FCA12077_IRIS_(LUXEON_T)_1 Eff.94.6% / LDC (Linear)

Luminaire: LEDiL Oy FCA12077_IRIS_(LUXEON_T)_1 Eff.94.6%
Lamps: 1 x LUXEON T (74lm@250mA)

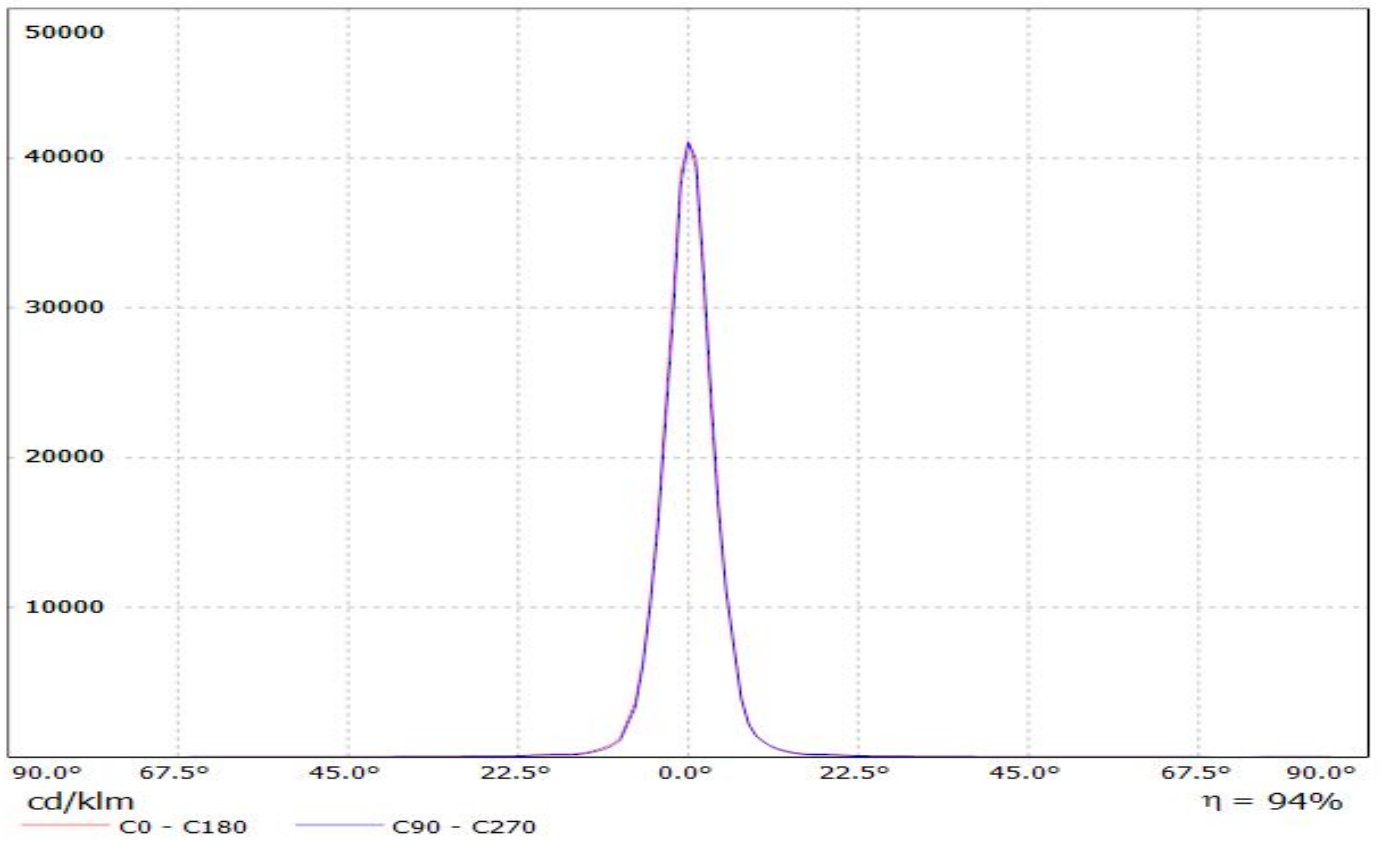

Luminaire: Ledil Oy FCA12077_IRIS_(Luxeon_TX)

Lamps: 1 x Philips Lumileds Luxeon TX (80.78lm @ 250mA) P=0.7W I=250mA

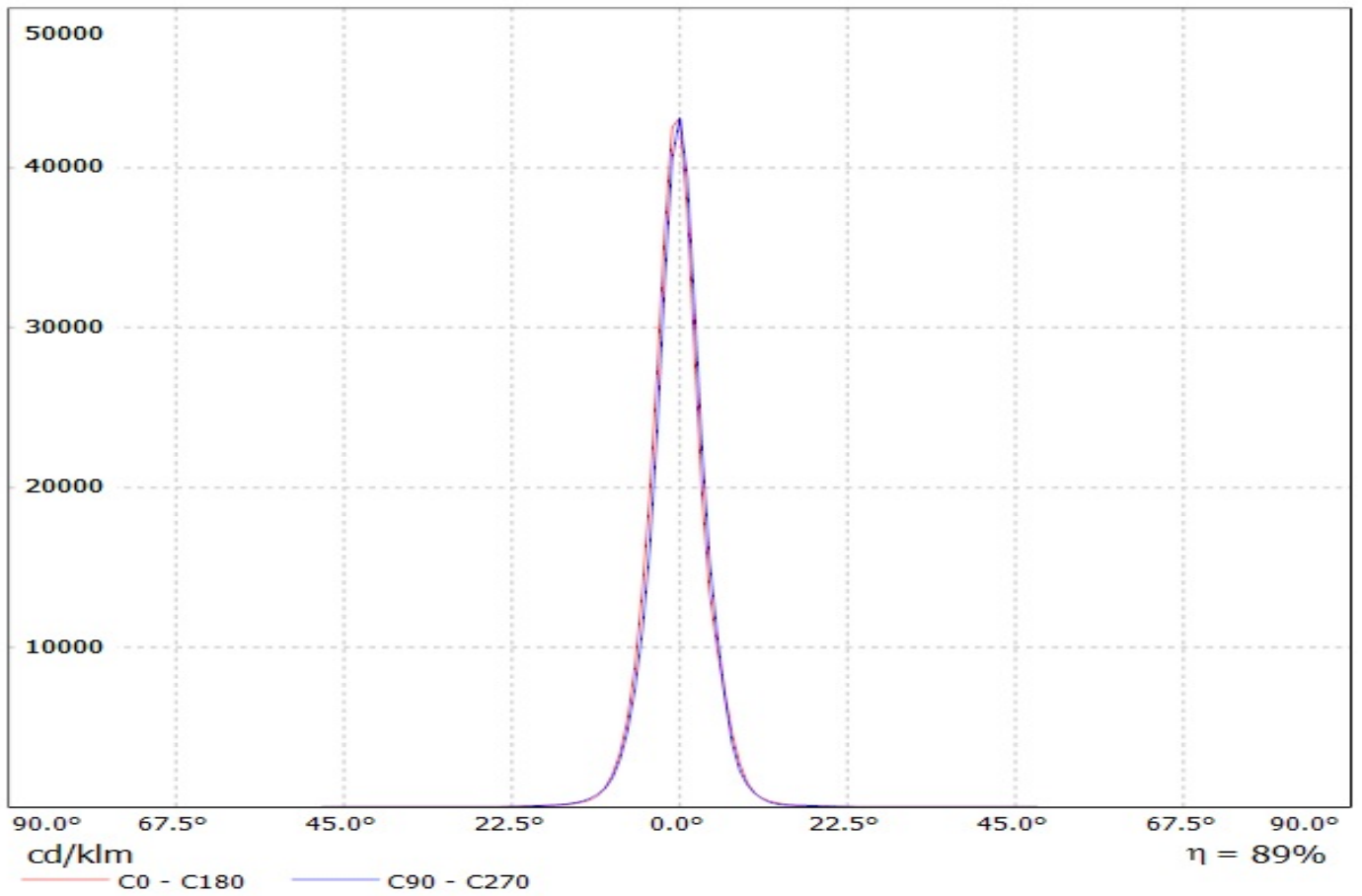

Luminaire: LEDiL Oy FCA12077_IRIS_(Z_ES)
Lamps: 1 x Philips_Lumileds_Luxeon_Z_ES_(LX22-5070)
_84.6528lm@250mA_P=0.730483W_I=249.9mA

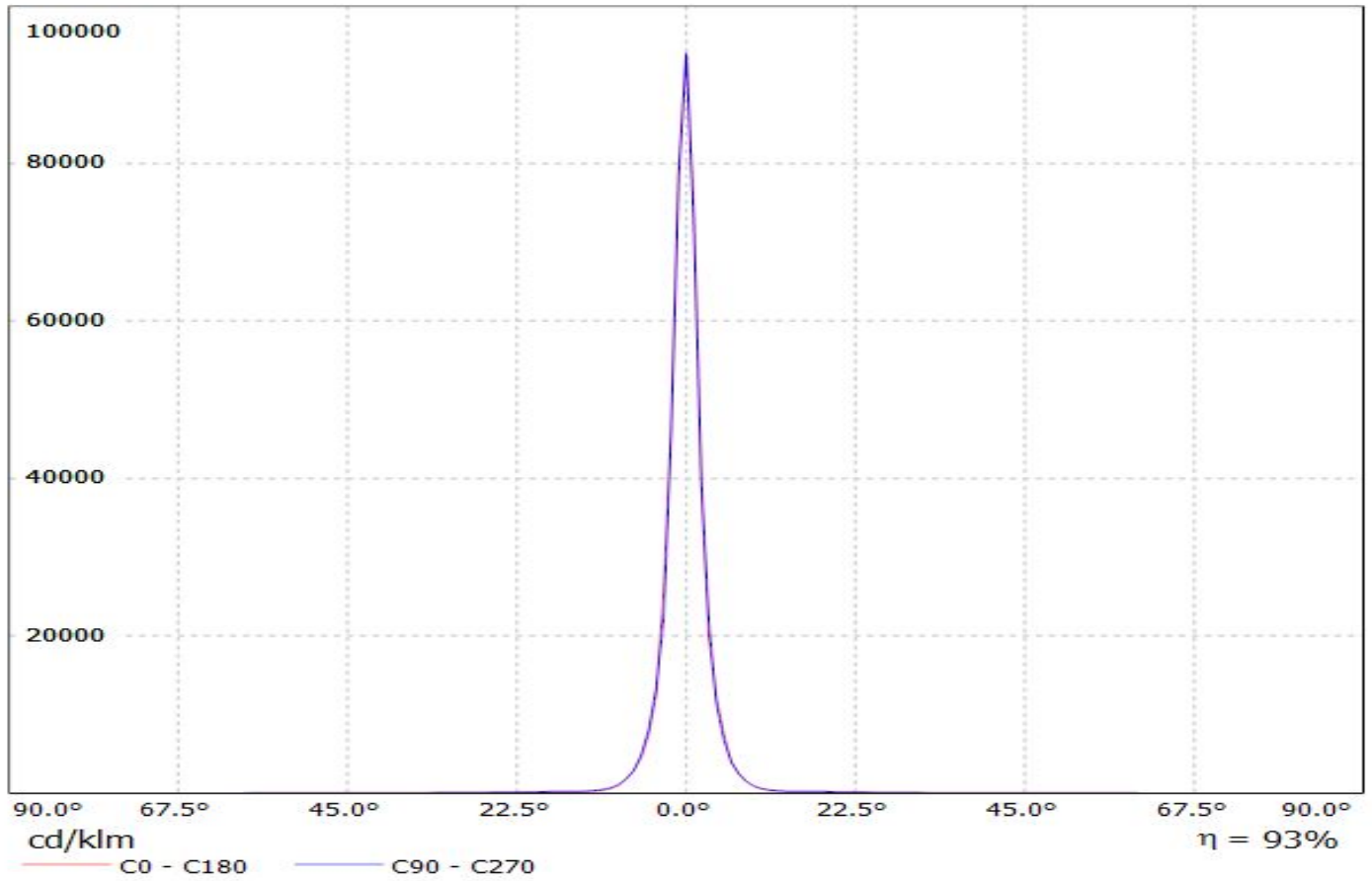

Luminaire: LEDiL Oy FCA12077_IRIS

Lamps: 1 x Nichia_NWSL229AE_120.514lm@250mA_P=0.7132W_I=0.250A

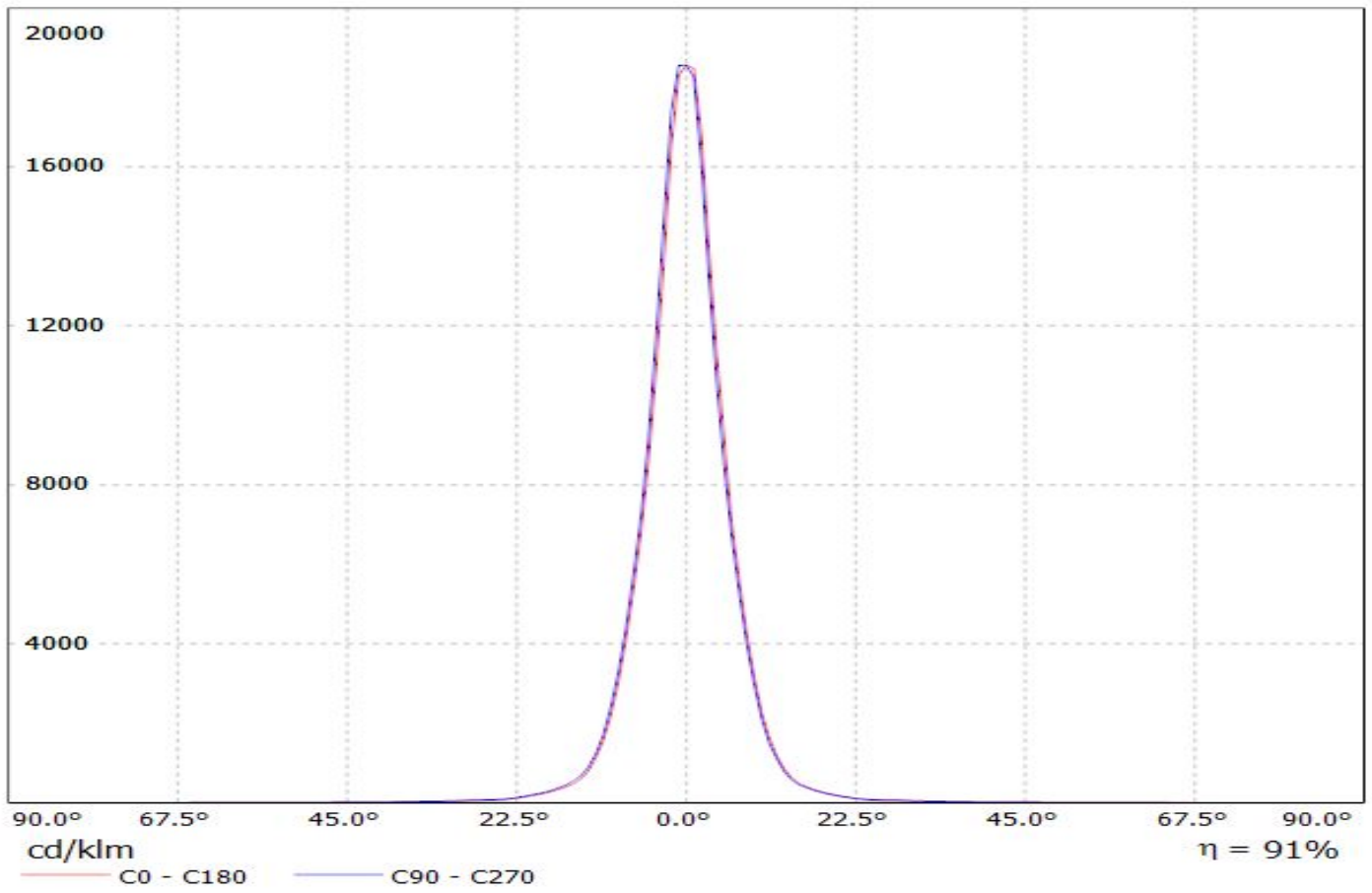

Luminaire: LEDiL Oy FCA12077_IRIS_(NVSL219CE)
Lamps: 1 x Nichia_NVSL219CE_101.052lm@250mA_P=0.713154W_I=0.25A

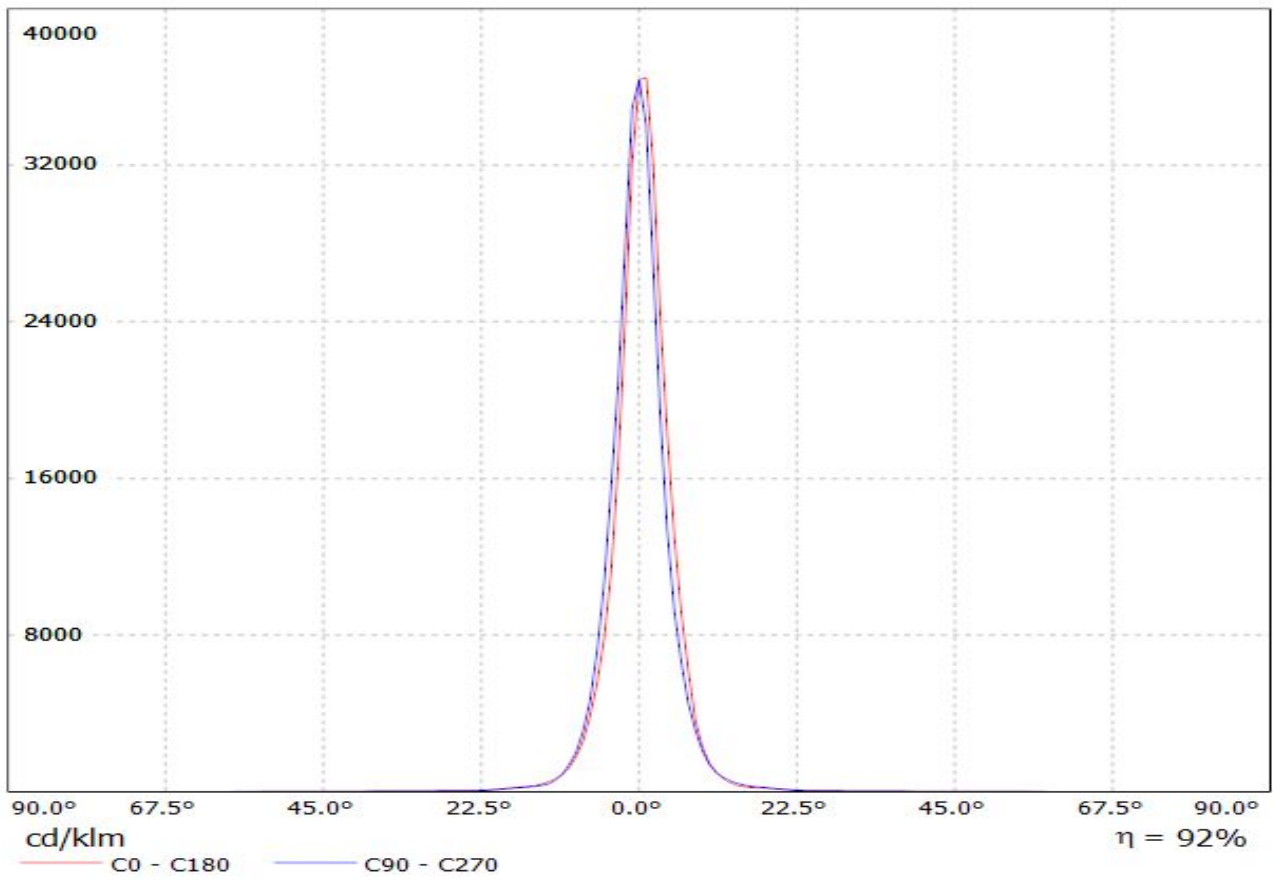

Luminaire: Ledil FCA12077_IRIS_(NVSW319AE)

Lamps: 1 x Nichia_NVSW319AE_126.092lm@250mA_P=0.73005W_I=0.25A

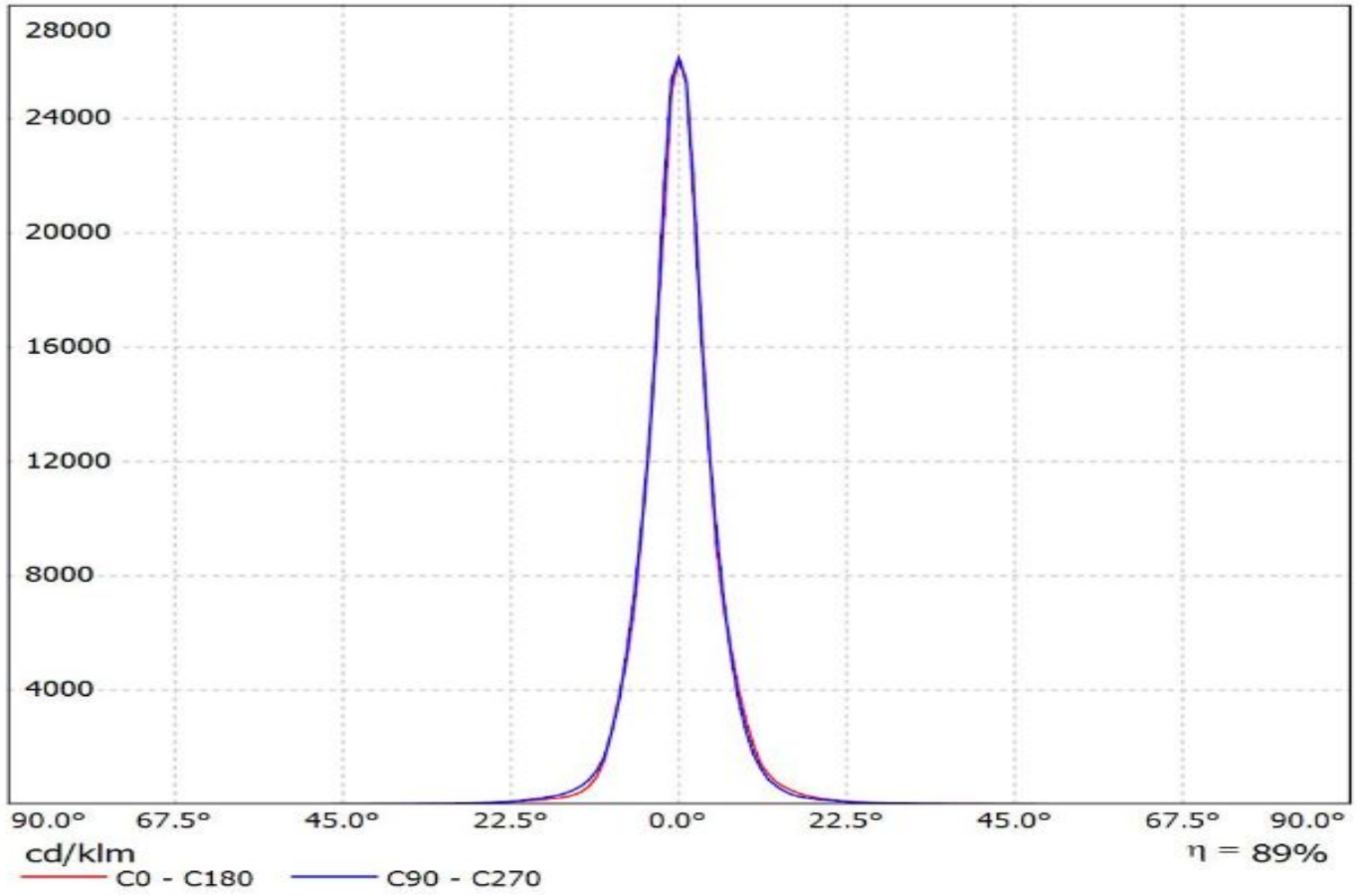

Luminaire: LEDil Oy FCA12077_IRIS_(LH351Z)

Lamps: 1 x Samsung LH351Z (90.14lm @ 250mA) CCT=6500K P=0.7W I=250mA

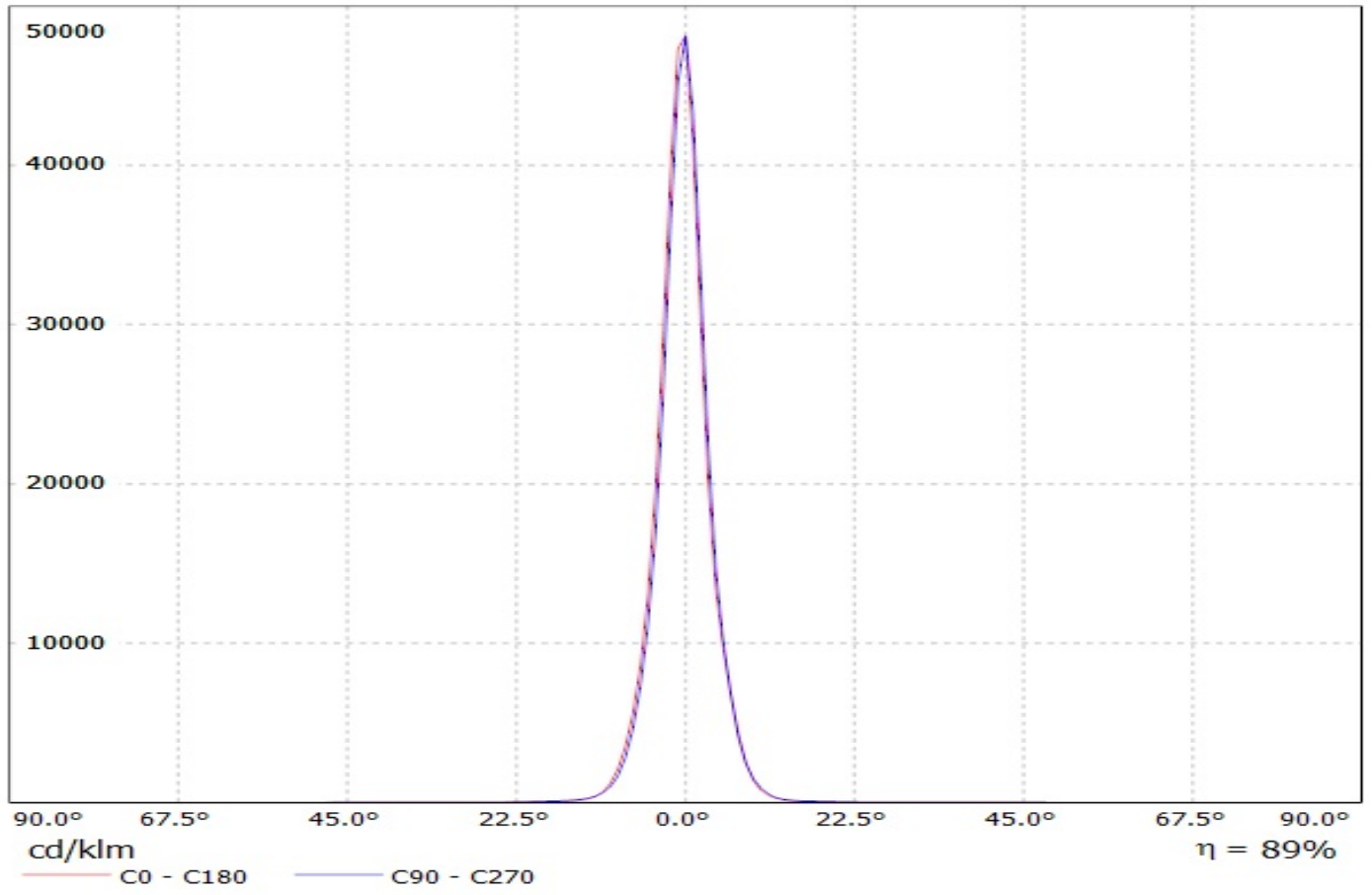

Valaisin: LEDIL OY FCA12077_IRIS_(XP-G2) Efficiency=95%
Lamput: 1 x Cree XP-G2 (109.1lm @ 250mA)

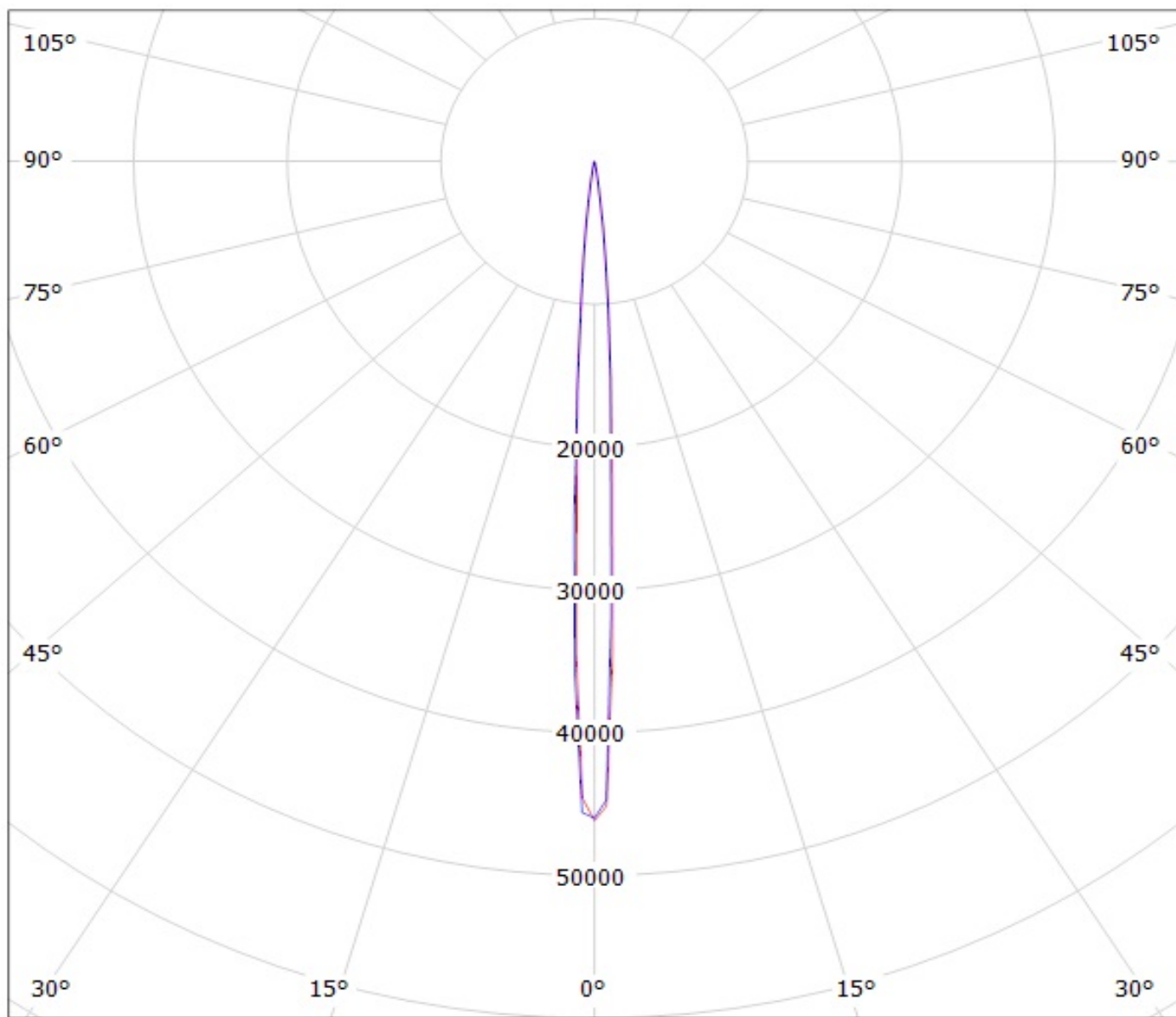

cd/klm

— C0 - C180 — C90 - C270

Luminaire: Ledil Oy FCA12077_IRIS_(XHP35_HD)_SIMULATED
Lamps: 1 x Cree XHP35 HD

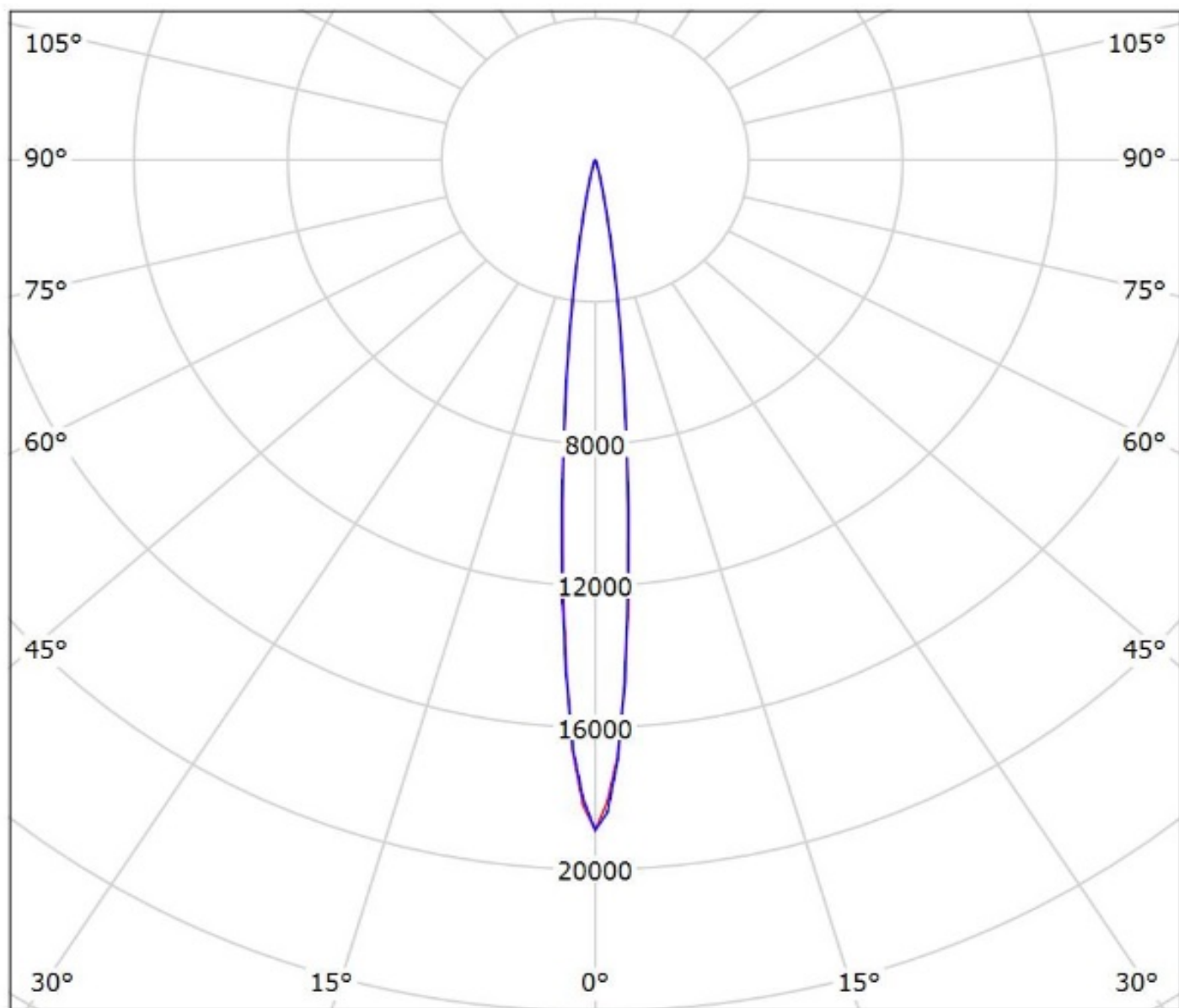

cd/klm

— C0 - C180 — C90 - C270

$\eta = 92\%$

Luminaire: Ledil Oy FCA12077_IRIS_(XHP35_HI)_SIMULATED
Lamps: 1 x Cree XHP35 HI

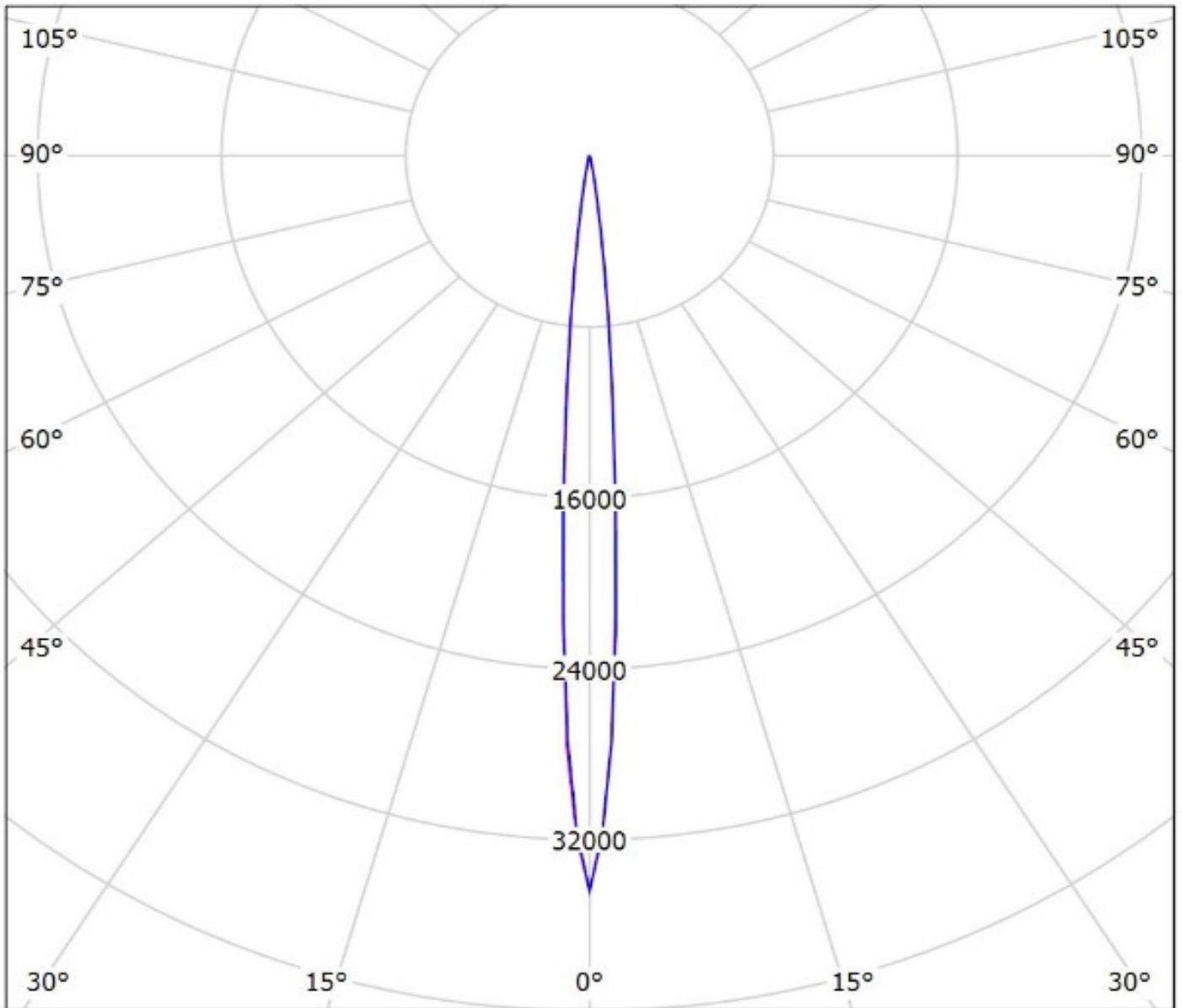

cd/klm

— C0 - C180 — C90 - C270

$\eta = 95\%$

Luminaire: Ledil Oy FCA12077_IRIS_(XQ-E_HI)_SIMULATED
Lamps: 1 x Cree XQ-E HI

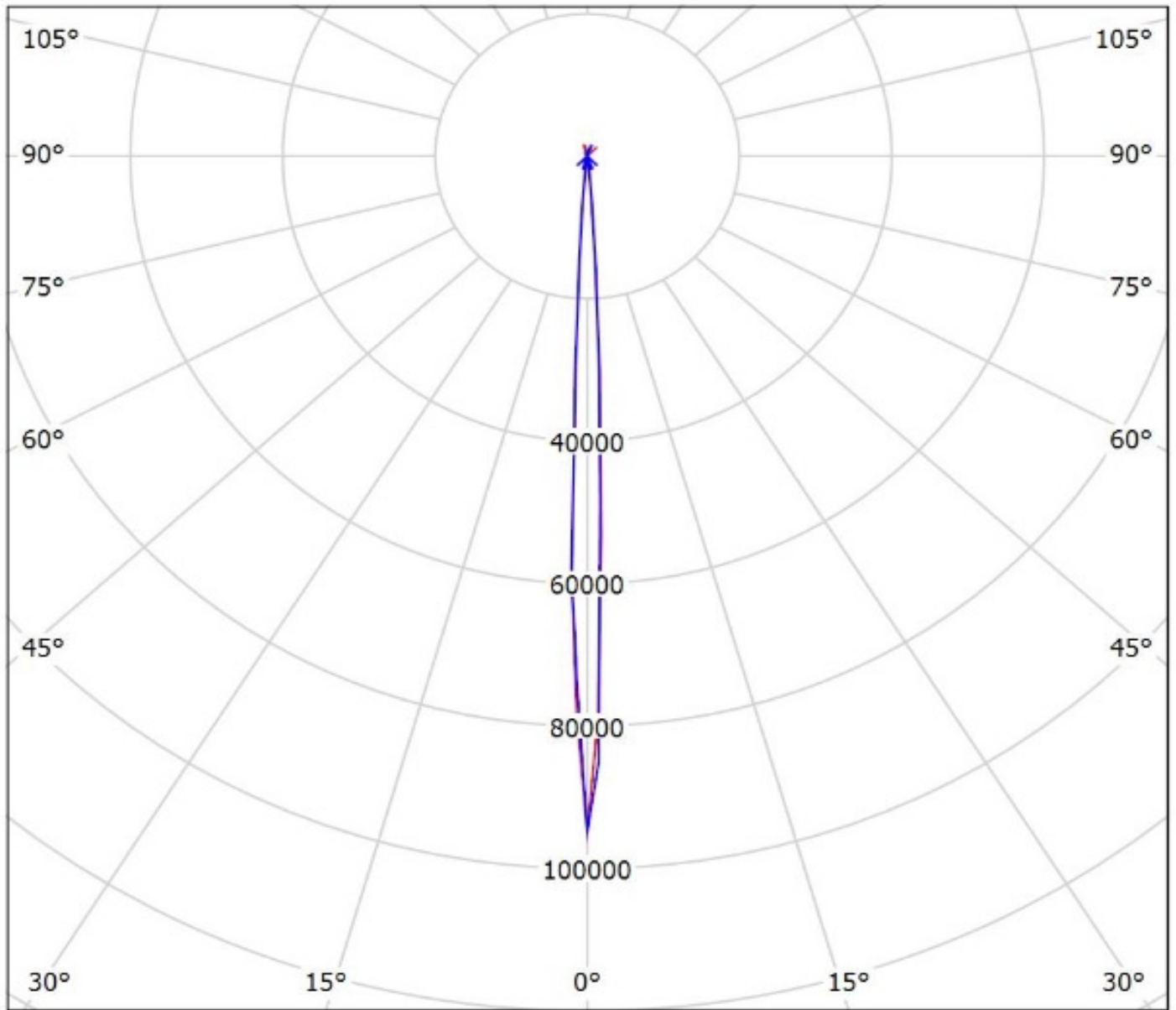

cd/klm

— C0 - C180 — C90 - C270

$\eta = 94\%$

Luminaire: Ledil Oy FCA12077_IRIS_(XP-G3)_SIMULATED
Lamps: 1 x Cree XP-G3

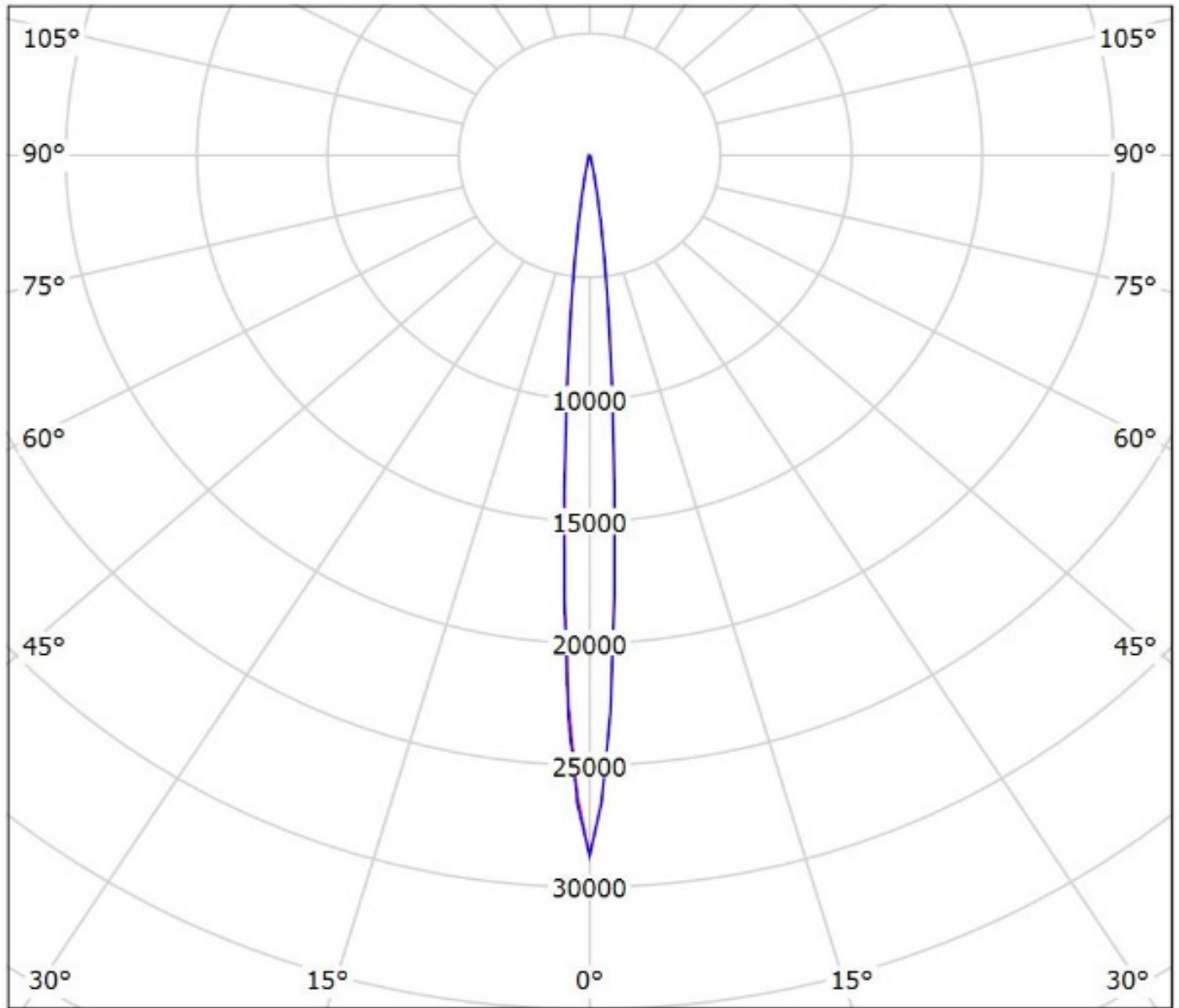

cd/klm
— C0 - C180 — C90 - C270

$\eta = 91\%$

Luminaire: Ledil Oy FCA12077_IRIS_(XP-E2)_SIMULATED
Lamps: 1 x Cree XP-E2

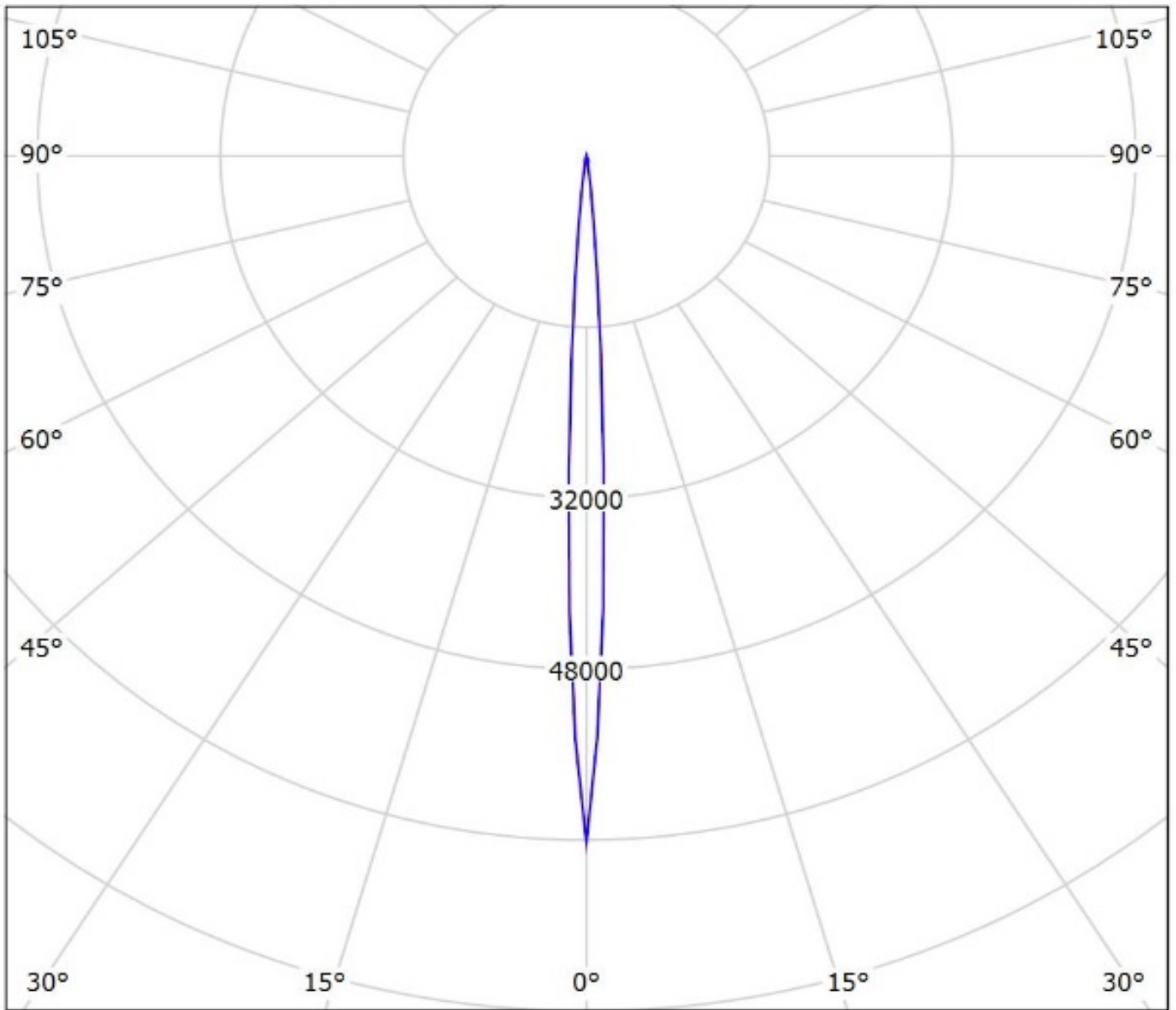

cd/klm

— C0 - C180 — C90 - C270

$\eta = 95\%$

Luminaire: Ledil Oy FCA12077_IRIS_(3535_Ceramic_gen2) Efficiency=89%
Lamps: 1 x LG 3535 Ceramic gen2 (PKG5700k) 116lm @ 250mA CCT=6200k P=0.7 I=250mA

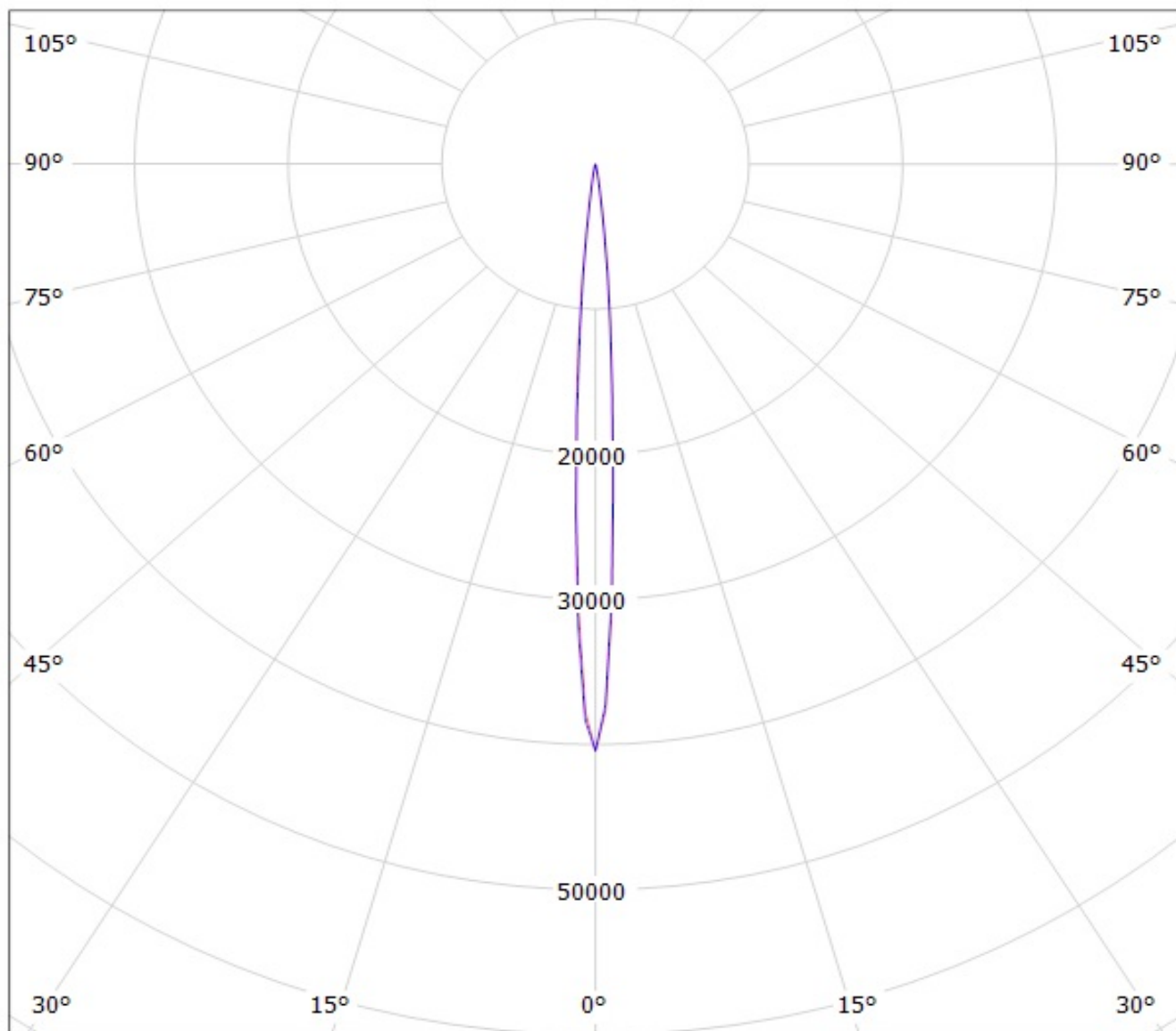

cd/klm

— C0 - C180 — C90 - C270

LEDiL Oy FCA12077_IRIS_(LUXEON_T)_1 Eff.94.6% / LDC (Polar)

Luminaire: LEDiL Oy FCA12077_IRIS_(LUXEON_T)_1 Eff.94.6%
Lamps: 1 x LUXEON T (74lm@250mA)

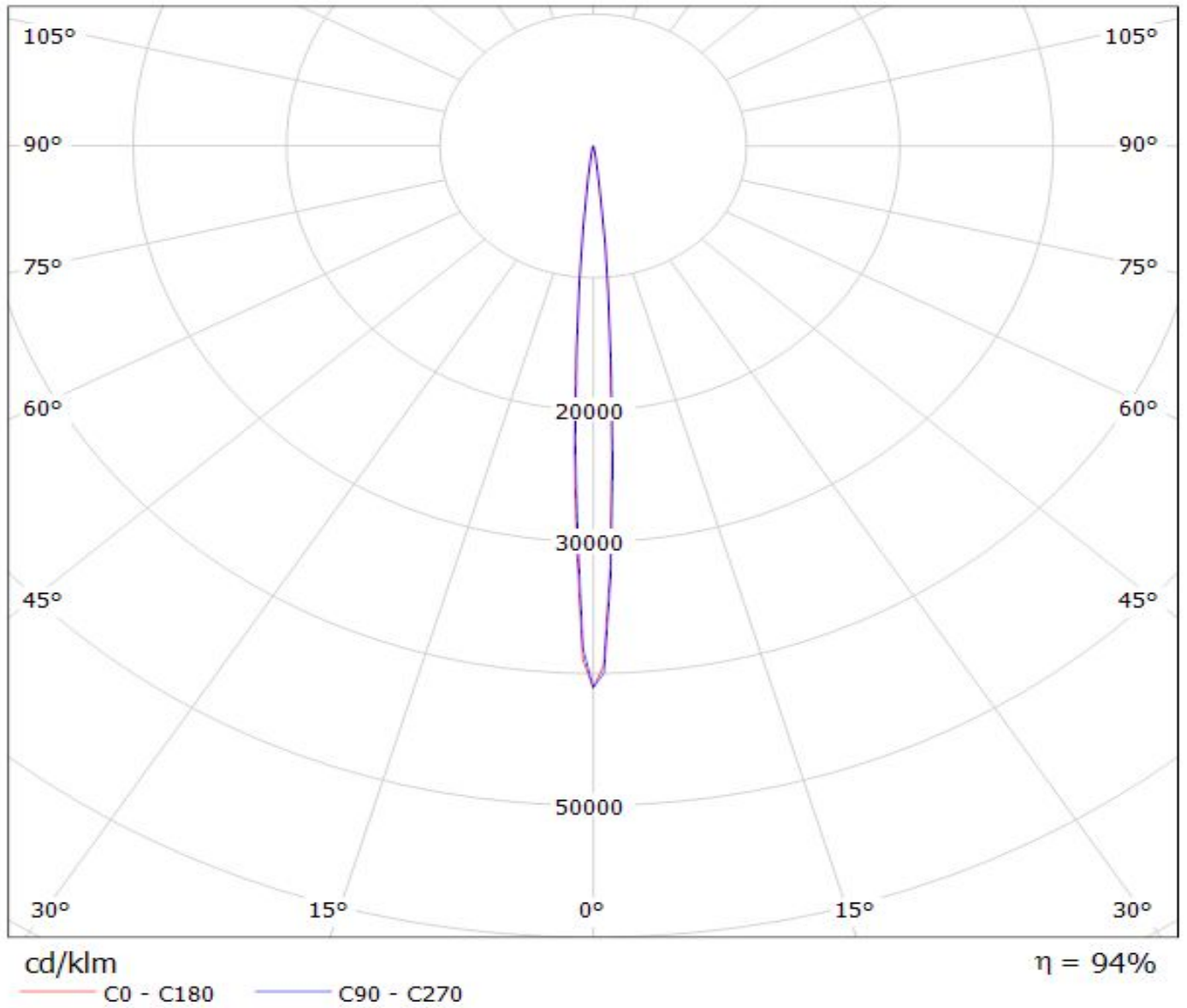

Luminaire: Ledil Oy FCA12077_IRIS_(Luxeon_TX)

Lamps: 1 x Philips Lumileds Luxeon TX (80.78lm @ 250mA) P=0.7W I=250mA

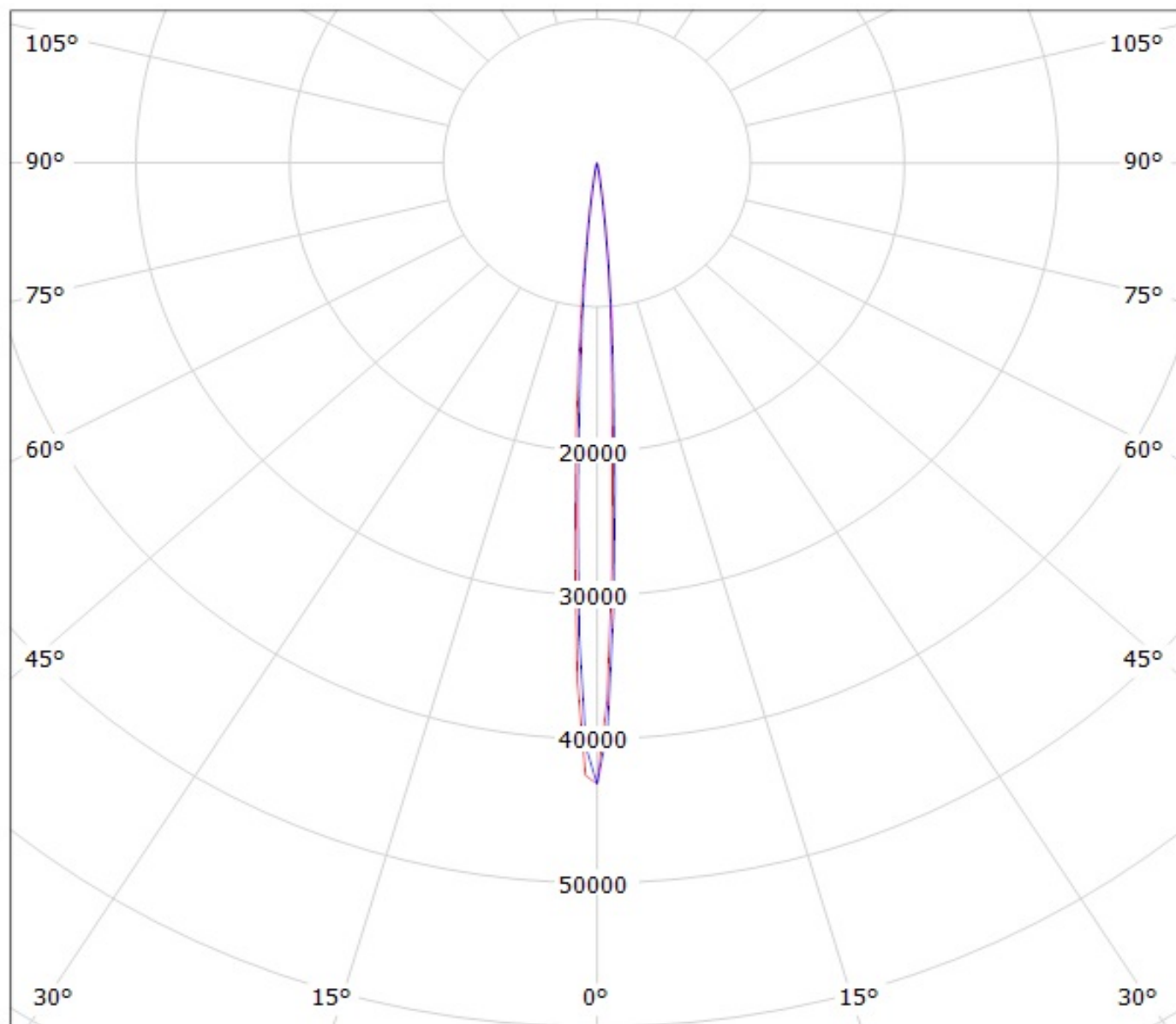

cd/klm

— C0 - C180

— C90 - C270

$\eta = 89\%$

Luminaire: LEDiL Oy FCA12077_IRIS_(Z_ES)
Lamps: 1 x Philips_Lumileds_Luxeon_Z_ES_(LXZ2-5070)
_84.6528lm@250mA_P=0.730483W_I=249.9mA

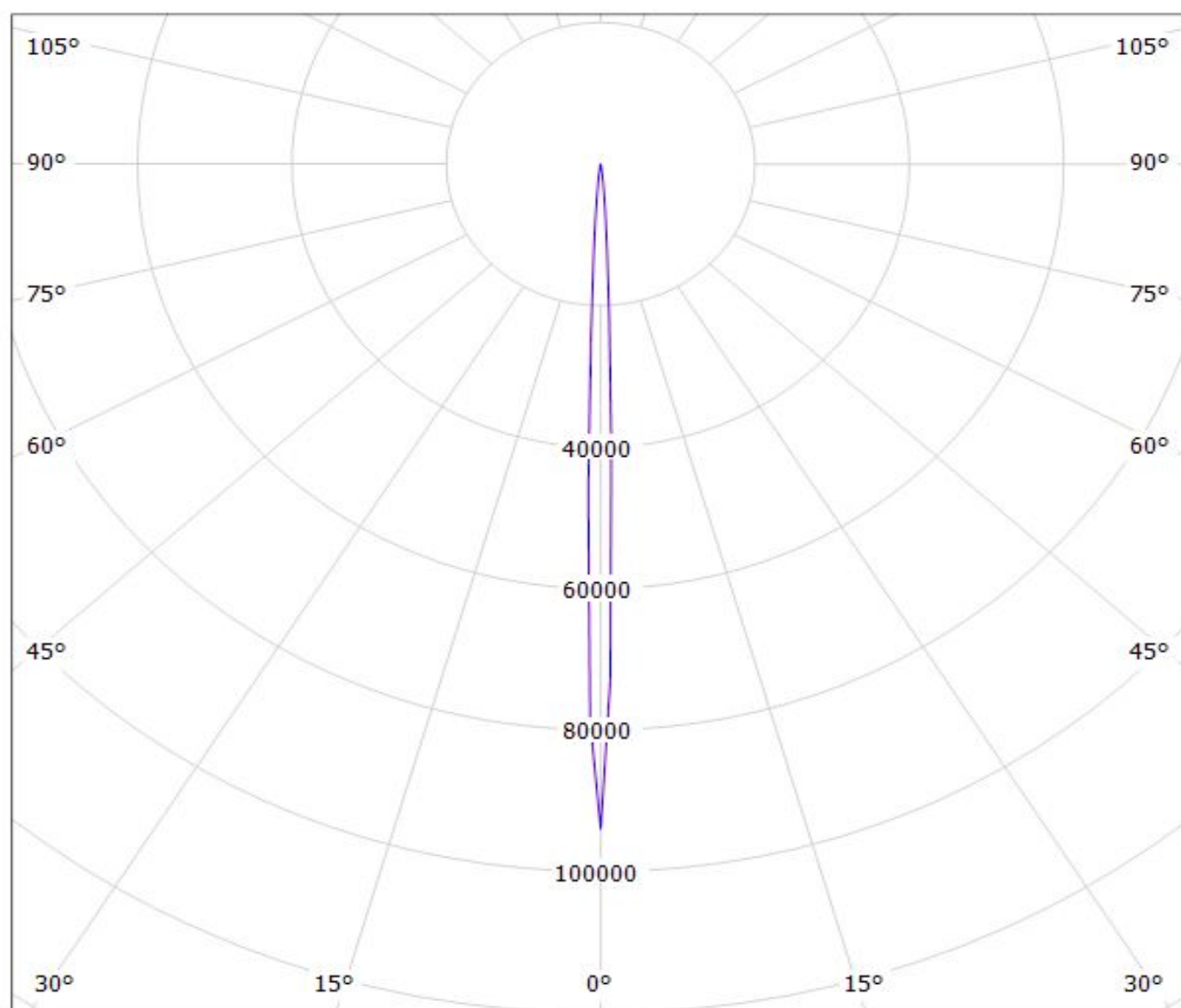

cd/klm

— C0 - C180

— C90 - C270

$\eta = 93\%$

Luminaire: LEDiL Oy FCA12077_IRIS

Lamps: 1 x Nichia_NWSL229AE_120.514lm@250mA_P=0.7132W_I=0.250A

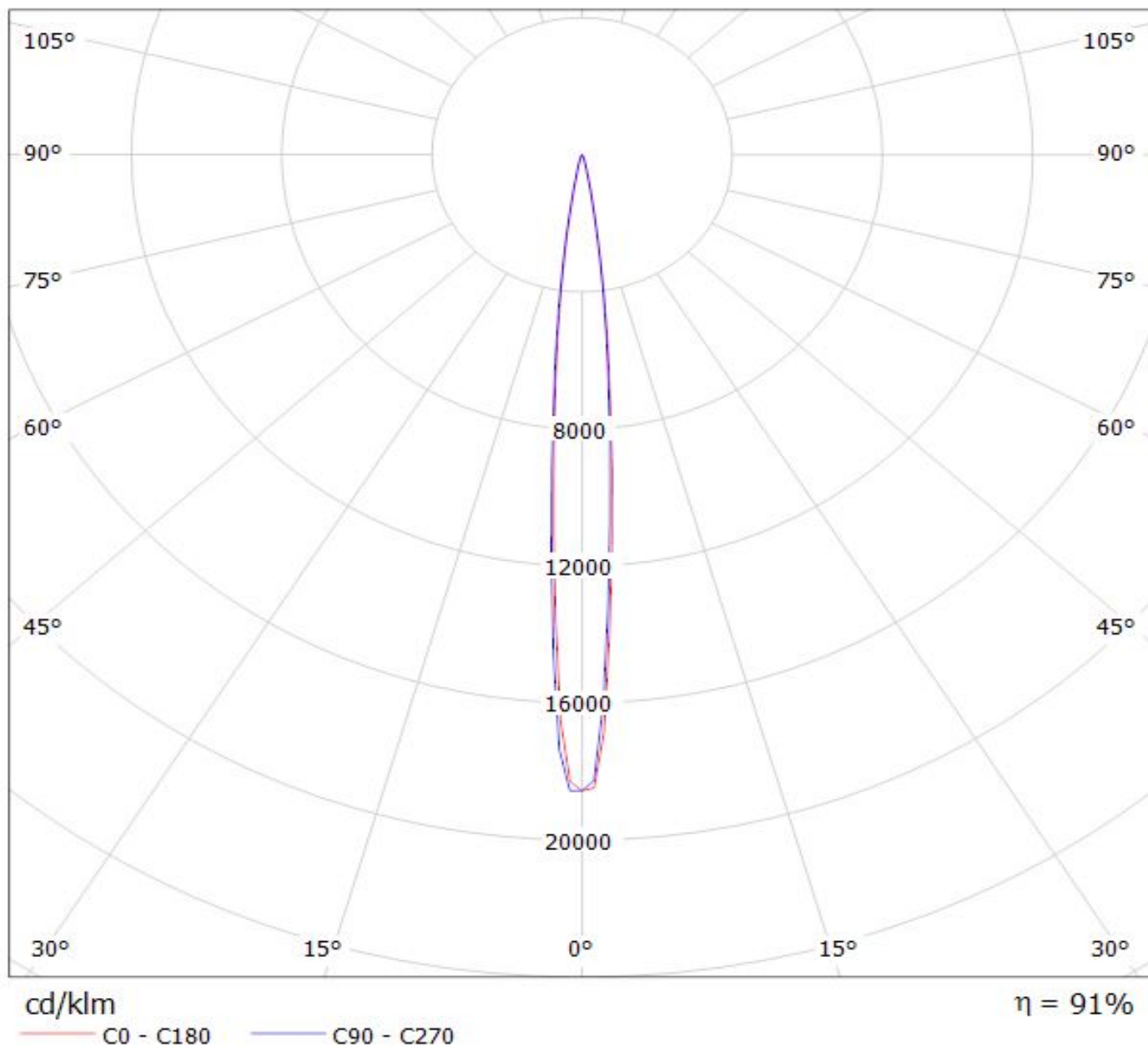

Luminaire: LEDiL Oy FCA12077_IRIS_(NVSL219CE)
Lamps: 1 x Nichia_NVSL219CE_101.052lm@250mA_P=0.713154W_I=0.25A

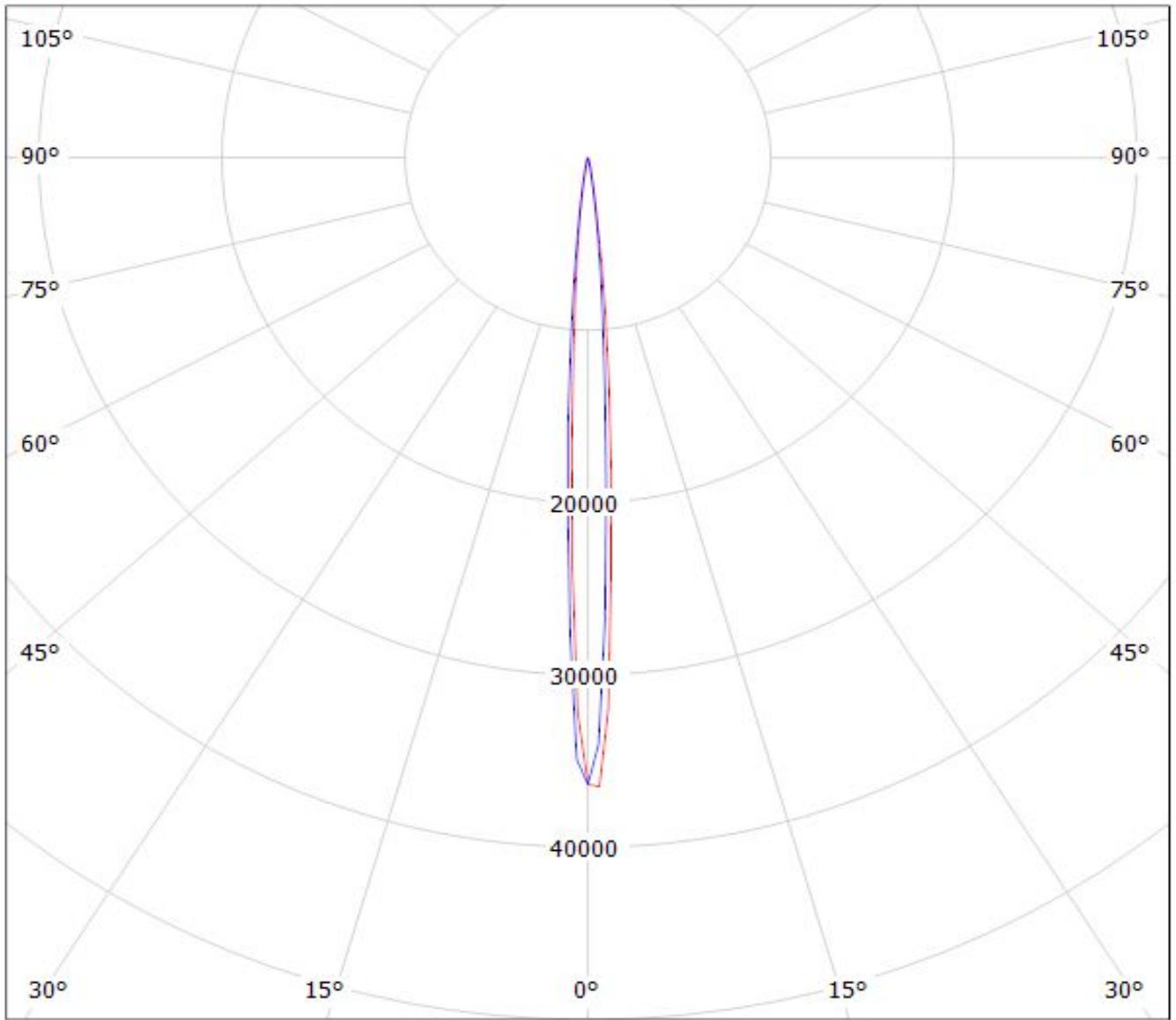

$\eta = 92\%$

cd/klm
— C0 - C180 — C90 - C270

Luminaire: Ledil FCA12077_IRIS_(NVSW319AE)

Lamps: 1 x Nichia_NVSW319AE_126.092lm@250mA_P=0.73005W_I=0.25A

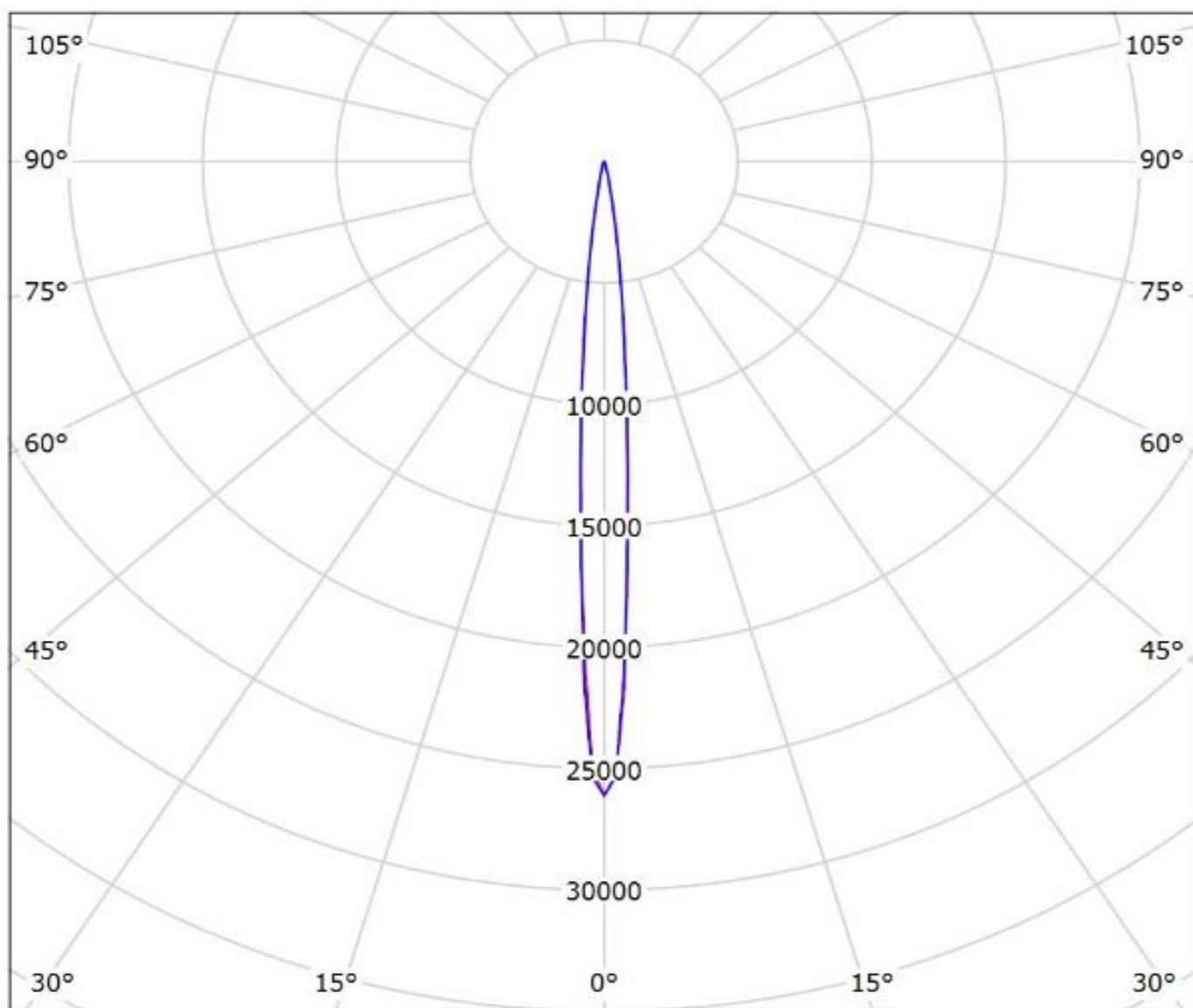

cd/klm

— C0 - C180

— C90 - C270

$\eta = 89\%$

Luminaire: LEDil Oy FCA12077_IRIS_(LH351Z)

Lamps: 1 x Samsung LH351Z (90.14lm @ 250mA) CCT=6500K P=0.7W I=250mA

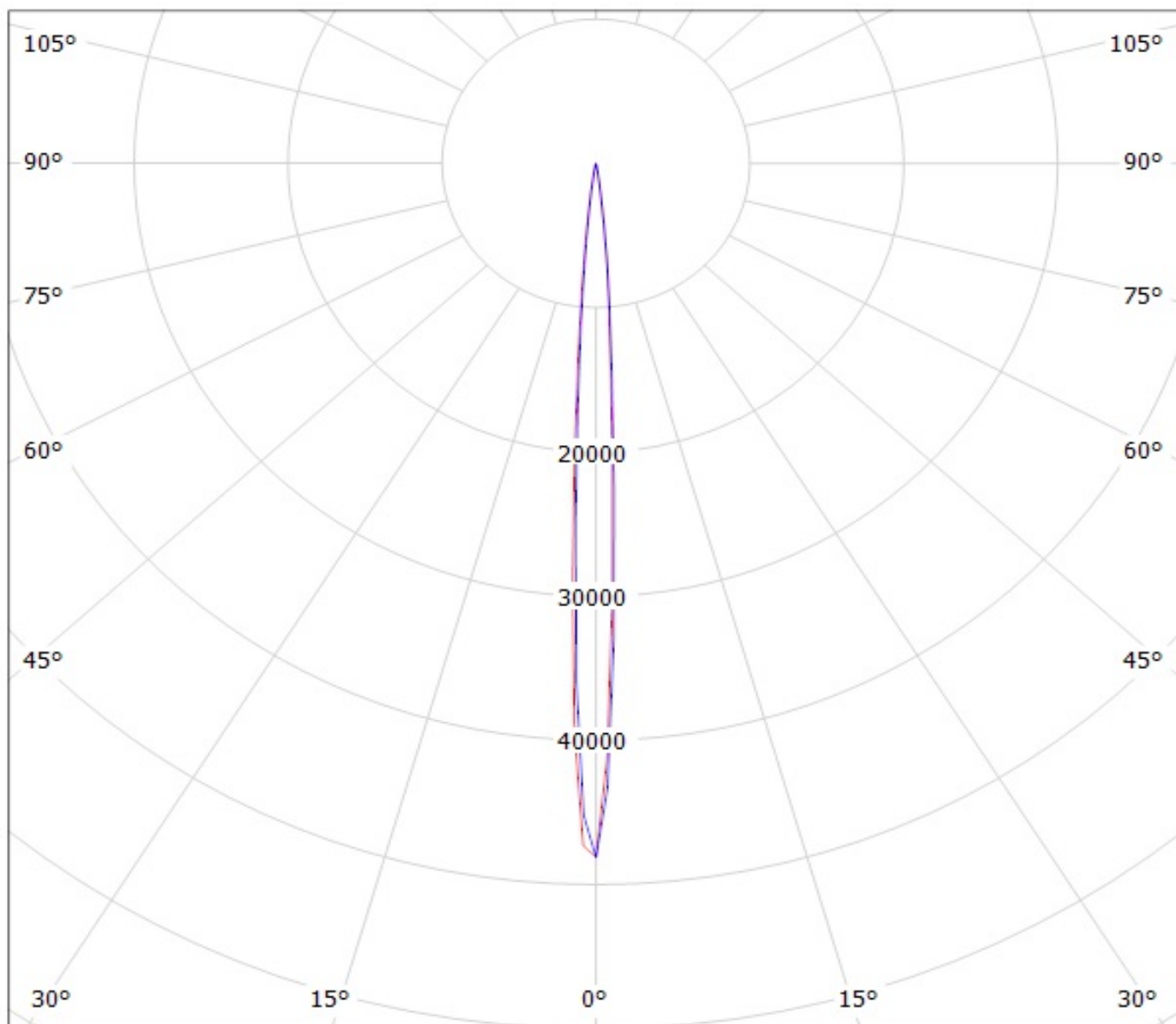

cd/klm

— C0 - C180

— C90 - C270

$\eta = 89\%$

NOTE: The typical divergence will be changed by different color, chip size and chip position tolerance. The typical total divergence is the full angle measured where the luminous intensity is half of the peak value.