

1214 - 300

300 Watts - 50 Volts, 100µs, 10%
Radar 1200 - 1400 MHz

GENERAL DESCRIPTION

The 1214-300 is an internally matched, COMMON BASE transistor capable of providing 300 Watts of pulsed RF output power at one hundred microseconds pulse width, ten percent duty factor across the band 1200 to 1400 MHz. This hermetically solder-sealed transistor is specifically designed for L-Band radar applications. It utilizes gold metalization and diffused emitter ballasting to provide high reliability and supreme ruggedness.

ABSOLUTE MAXIMUM RATINGS

Maximum Power Dissipation @ 25°C 1458 Watts

Maximum Voltage and Current

BVces	Collector to Emitter Voltage	65 Volts
BVebo	Emitter to Base Voltage	3.5 Volts
Ic	Collector Current	17 Amps

Maximum Temperatures

Storage Temperature	- 65 to + 200°C
Operating Junction Temperature	+ 200°C

CASE OUTLINE 55KT, STYLE 1

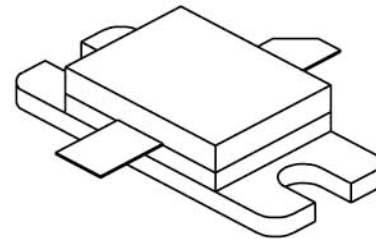

ELECTRICAL CHARACTERISTICS @ 25 °C

SYMBOL	CHARACTERISTICS	TEST CONDITIONS	MIN	TYP	MAX	UNITS
Pout	Power Out (Note 2)	F = 1200-1400 MHz	270			Watts
Pin	Power Input	Vcc = 50 Volts			42.7	Watts
Pg	Power Gain	Pulse Width = 100 µs	8.0			dB
ηc	Collector Efficiency	Duty = 10 %		45		%
VSWR ¹	Load Mismatch Tolerance	F = 1400MHz, Po = 270W			3:1	

BVces	Collector to Emitter Breakdown	Ic = 50 mA	65			Volts
BVebo	Emitter to Base Breakdown	Ie = 25 mA	3.0			Volts
Hfe	DC Current Gain	Vce = 5 V, Ic = 5 mA	10	45		
θjc ¹	Thermal Resistance	Rated Pulse Condition			0.25	°C/W

Note 1: Pulse condition of 100µsec, 10%.

Note 2: Product Selected to 300 Watt minimum is available, please contact the factory for details.

POWER OUTPUT vs POWER INPUT

Vcc = 50 V, PW = 100 us, 10%

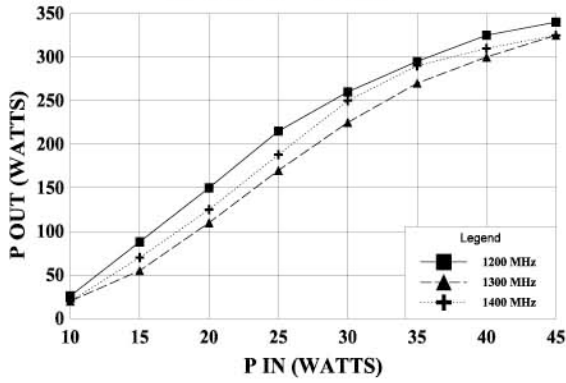

POWER OUPUT AND EFF. vs FREQUENCY

Vcc = 50 V, Pin = 40 W, 100 us, 10%

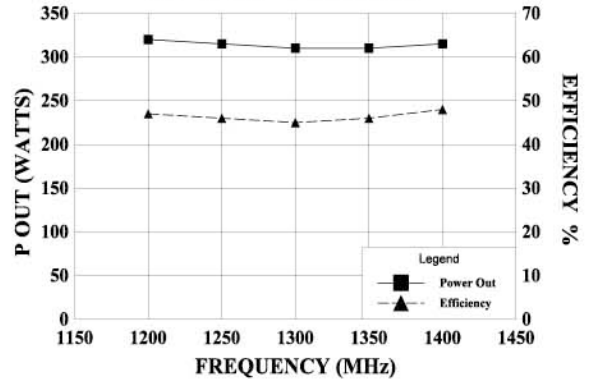

LOAD IMPEDANCE vs FREQUENCY

Zcl = Rcl - jXcl (Vcc = 50V, Po = 300W)

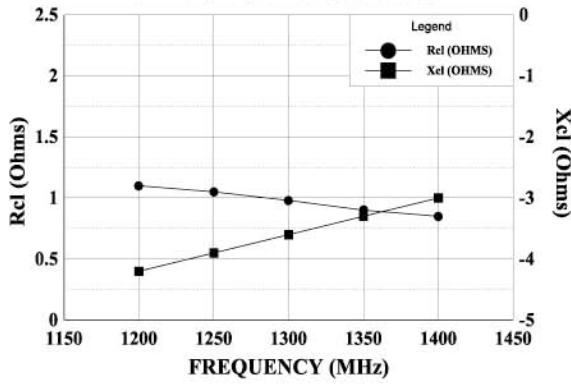

INPUT IMPEDANCE vs FREQUENCY

Zin = R + jX (Vcc = 50V, Po = 300W)

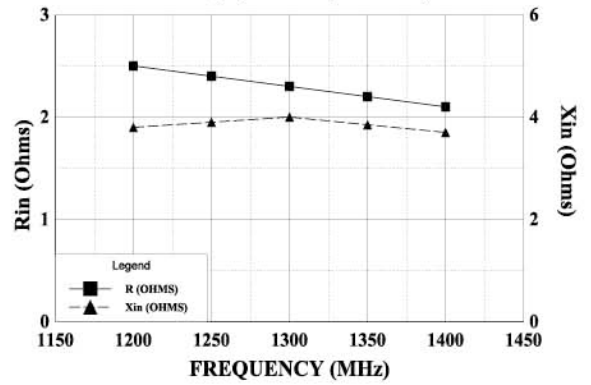

REVISIONS

ZONE	REV	DESCRIPTION	DATE	APPROVED
------	-----	-------------	------	----------

DIM	INCHES
A	.700
B	.100
C	.250
D	.100
E	.025
F	.140
G	.295
H	.127
I	.100
J	.230
K	.780
L	.025
M	.135
N	.080
O	.025
P	.300
Q	.030
R	.155
S	.220
T	.100

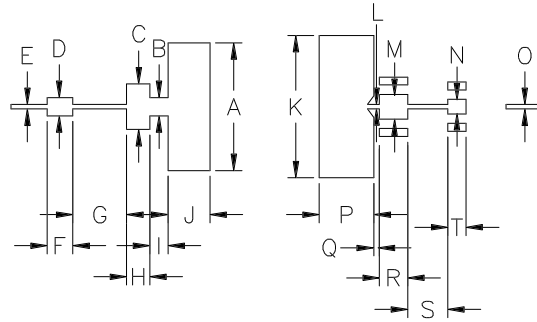

1214-300 TEST CIRCUIT

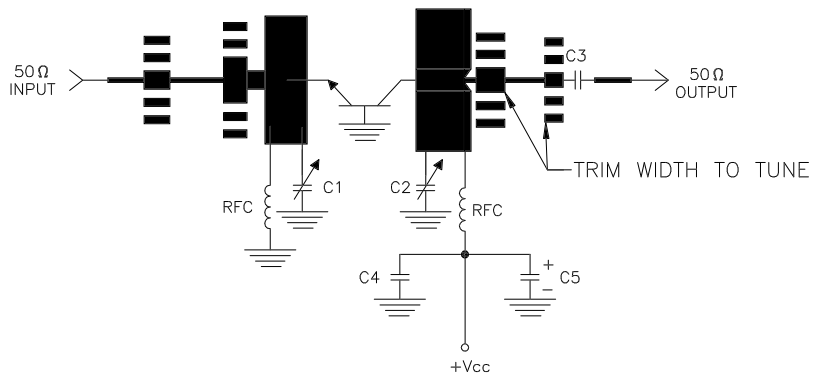

— = Microstrip on 0.025" Epsilam 10, Er=10
 C1,C2 = 0.35-3.5pF JOHANSON trimmer
 C3,C4 = ATC Chip 82pF
 C5 = 220MF, 63V.



CAGE OPJR2	DWG NO. 1214-300	REV A
	SCALE 1/1	SHEET