

D

C

B

A

4

4

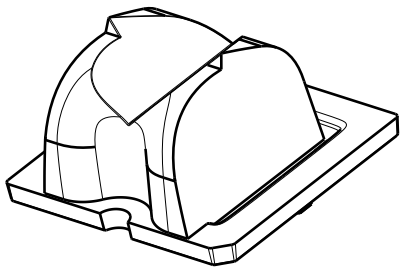

Isometric view

Bottom view

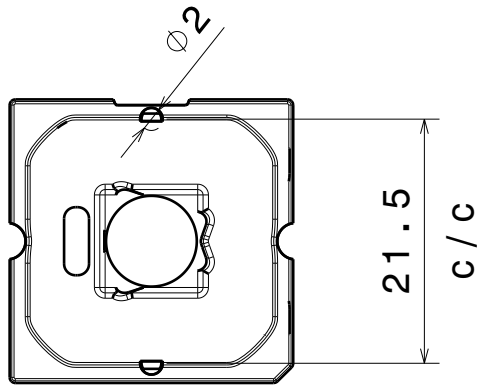

21.5
C/C

3

3

Front view

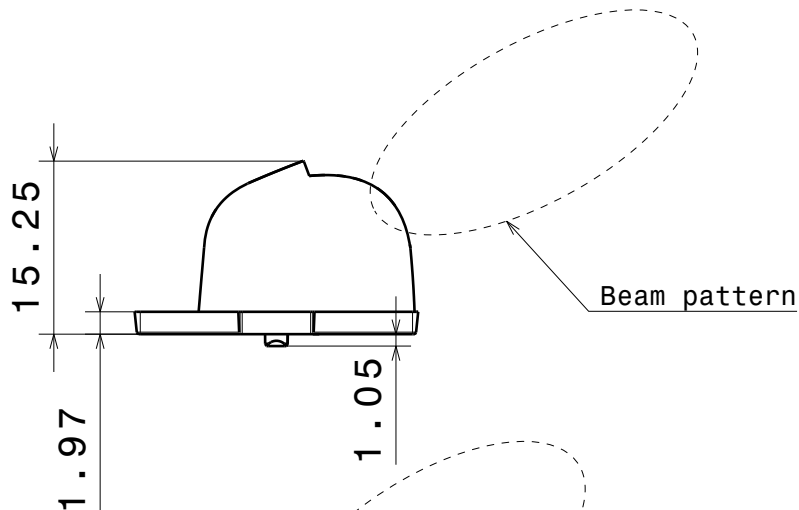

15.25
1.97
1.05

Beam pattern

2

2

Top view

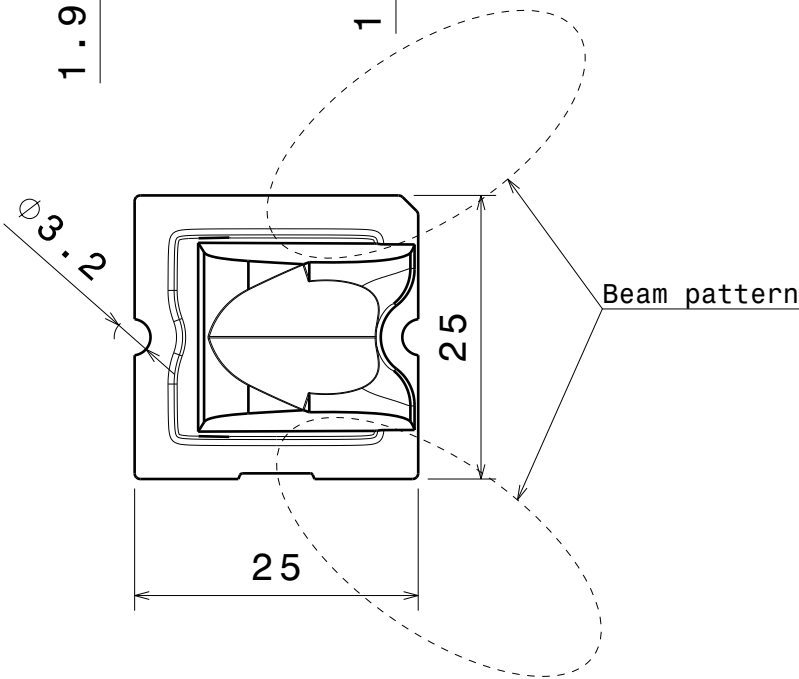

3.2
25
25

Beam pattern

INDEX	PART NO	DESCRIPTION	MATERIAL	COLOUR
1	C13751	STRADA-SQ-FW	PMMA	

Tolerances if not otherwise shown
According to DIN ISO 2768-1
Linear measures:
up to 30mm class M, otherwise class C
According to DIN ISO 2768-2
Form and position: class L



Ledil Oy
Salorankatu 10
FIN 24240 SALO
Finland

THIRD ANGLE PROJECTION:



DRAWING TITLE

C13751_STRADA-SQ-FW

This drawing is the property
of LEDiL Oy. It may not be
reproduced, copied or
communicated without a written
agreement with LEDiL Oy.

SIZE PART NUMBER

A4

C13751

SCALE 3:2 WEIGHT 3,28 g SHEET 1/1

D

A

1

1