

GEN. ST.	01	02	03	04	05	06	07	08	0D	50	60	70	80	90																	
INT. ST.	10	11	12	13	14	18	20	31	32	33	34	38	39	40	42	43	44	45	46	48	56	70	72	73	75	76	81	82	83	84	88

REV.	DATE	DESCRIPTION	BY	C'K'D'
A	13-09-01	CONVERSION REVISION 08	KN	
B	2009-02-21	109-0027	AB	AB

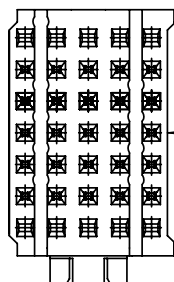

RoHS COMPATIBLE
(DIGIT 11 & 12)

HM2H0-P1--LF

STANDOFF HEIGHT INDICATOR

PART NR.		
HM2H04P1--LF	NO DISCRIMINATION	AVAILABLE
HM2H03P1--LF	DISCRIMINATION IN POS.5	AVAILABLE
HM2H02P1--LF	DISCRIMINATION IN POS. 1	AVAILABLE

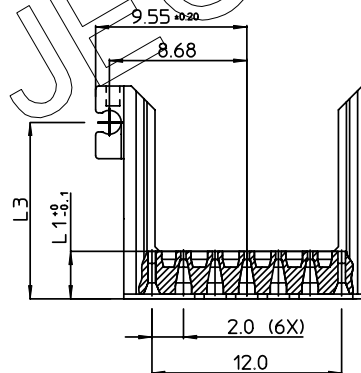
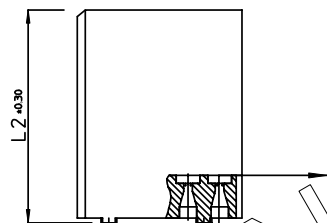

DISCRIMINATION
IN POS. 1

DISCRIMINATION
IN POS. 5

NO DISCRIMINATION

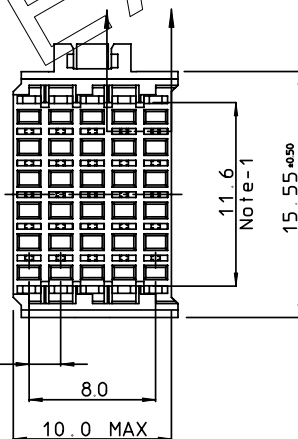
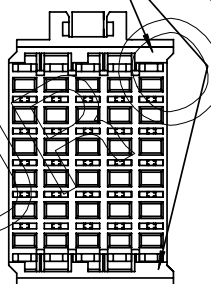
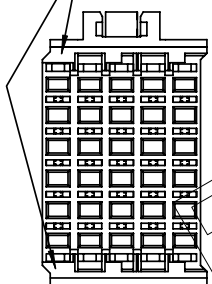

PART NUMBER	L1	L2	L3	
HM2H0-P1LF	3.0	13.45	11.15	AVAILABLE
HM2H0-P109LF	3.9	14.35	12.05	AVAILABLE
HM2H0-P115LF	4.5	14.95	12.65	AVAILABLE

NOTES:

1. MEASURED AT THE BOTTOM
2. MATERIAL: GLASSREINFORCED POLYESTER UL94 - V0
3. THE *LF* PRODUCT MEETS EUROPEAN UNION DIRECTIVES AND OTHER COUNTRY REGULATIONS AS DESCRIBED IN GS-22-008.
4. PARTS WITH AND WITHOUT SUFFIX LF TO THE PRODUCT PART NUMBER ARE IDENTICAL IN FORM, FIT AND FUNCTION. LF SUFFIX IS ADDED TO THE PART NUMBER OF THIS PRODUCT TO HAVE UNIFORM IDENTIFICATION OF ALL RoHS COMPATIBLE PRODUCTS.

1DEC ±0.2 2DEC ±0.1 ANGLES ±1°	APPR.	DATE	SIGN.	REAR HEADER WITH LOCKING DEVICE (25 POS)	
	DRAFT	1993-06-07	W. Panis	CAT. No. HM2H0-P1--LF	
WE RESERVE THE RIGHT TO CHANGE DIMENSIONS OR REQUIREMENTS WITHOUT PRIOR NOTICE.	CHECKED			 www.fciconnect.com	
	PROD. MGR				SCALE
	PR. ENG. MGR				3 / 1
ALL DIMENSIONS IN MM	PR. MGT. MGR			BS,C ,201630,002 B DRAWING No. CUSTOMER DRAWING REVISION	

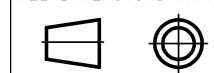

REFERENCES

THIS IS OUR EXCLUSIVE PROPERTY. IT IS NOT TO BE COPIED, REPRINTED OR DISCLOSED TO A THIRD PARTY, NOR USED FOR MANUFACTURING WITHOUT OUR WRITTEN CONSENT, AND HAS TO BE RETURNED TO US IN CASE OF NO USAGE

DIT IS ONZE EIGENDOM EN MAG NOCH NAGEMAAKT, HERDRUKT, OVERGEMAAKT AAN DERDEN, NOCH VOOR FABRIKATIE GEBRUIKT WORDEN, ZONDER ONZE SCHRIFTELIJKE TOELATING. BIJ NIET GEBRUIK IS TERUGZENDEND VERPLICHT.