



KYOCERA Display Corporation

APPROVAL SHEET

承認書

Customer 客戶名稱	
Part No. 產品型號	TVL-55733GD035J-LW-G-AAN
Product type 產品內容	3.5" TFT module: Transmissive Type, Normally white mode , RGB vertical stripe,
RoHS 綠色產品	<input type="checkbox"/> Non-compliance <input checked="" type="checkbox"/> Compliance
Remarks 備註欄	
<p><input checked="" type="checkbox"/> Preliminary Specification 暫行規格</p> <p><input type="checkbox"/> Final Specification 正式規格</p> <p>Signature by Customer: 客戶確認簽章:</p>	

Issued by QA	Checked by QA	Checked by PM	Approved By	
			QA	RD



KYOCERA Display Corporation

Specification of LCD Module

Project No.: TVL-55733GD035J-LW-G-AAN

Issue date: 2013/02/21

KYOCERA DISPLAY CORPORATION

5-7-18, Higashinipponi Arakawa-ku ,
Tokyo 116-0014, Japan
TEL: +81-3-5811-8780
FAX: +81-3-5811-8782



KYOCERA Display Corporation

TABLE OF CONTENTS

1. GENERAL DESCRIPTION.....	5
2. FEATURES	5
3. MECHANICAL SPECIFICATION	5
4. MECHANICAL DIMENSION	6
5. MAXIMUM RATINGS.....	7
6. ELECTRICAL CHARACTERISTICS	8
6.1. TFT LCD Characteristic.....	8
6.2. Backlight Characteristic	8
7. MODULE FUNCTION DESCRIPTION	9
7.1. PIN Description.....	9
7.2. Timing characteristics.....	11
8. ELECTRO-OPTICAL CHARACTERISTICS	16
9. APPLICATION NOTE	18
9.1. Suggestion of SPI code	18
10. RELIABILITY	19
10.1. MTTF	19
10.2. TESTS	19
10.3. Color performance	20
11. INSPECTION CRITERIA.....	20
11.1. Inspection Conditions.....	20
11.2. Light Method	21
11.3. Classification Of Defects.....	21
11.4. Sampling & Acceptable Quality Level	21
11.5. Definition Of Inspection Area	22
11.6. Items and Criteria.....	22



KYOCERA Display Corporation

12. ROHS COMPLIANT WARRANTY	25
13. PRECAUTIONS FOR USE.....	26
13.1. Safety.....	26
13.2. Storage Conditions	26
13.3. Installing LCD Module.....	26
13.4. Precautions for Operation	26
13.5. Handling Precautions.....	27
13.6. Warranty	27
14. REVISION HISTORY	27

KYD Confidential Document

1. GENERAL DESCRIPTION

TVL-55733GD035J-LW-G-AAN is a Transmissive type color active matrix liquid crystal display (LCD), which uses amorphous thin film transistor (TFT) as switching devices. This product is composed of a TFT LCD panel, driver ICs, FPC, and a backlight unit. The following table described the features of TVL-55733GD035J-LW-G-AAN.

2. FEATURES

Display Mode	Transmissive Type
	TFT LCD, Positive
Display Format	RGB Strip type
Driver IC.	ILI9322-B
Color	16.7M color
Interface	8 bits RGB serial data
Viewing Direction	Higher Contrast ratio: 6 O'clock Less gray scale reversal: 12 o'clock
Backlight type / color	LED / white *6

3. MECHANICAL SPECIFICATION

Item	Specifications	Unit
Dimensional outline	76.9(W)×63.9(H)×3.2(D)	mm
Resolution	320×(R,G,B)×240	dot
Active area	70.08(W)×52.56(H)	mm
Pixel pitch	0.219(W)×0.219(H)	mm

4. MECHANICAL DIMENSION

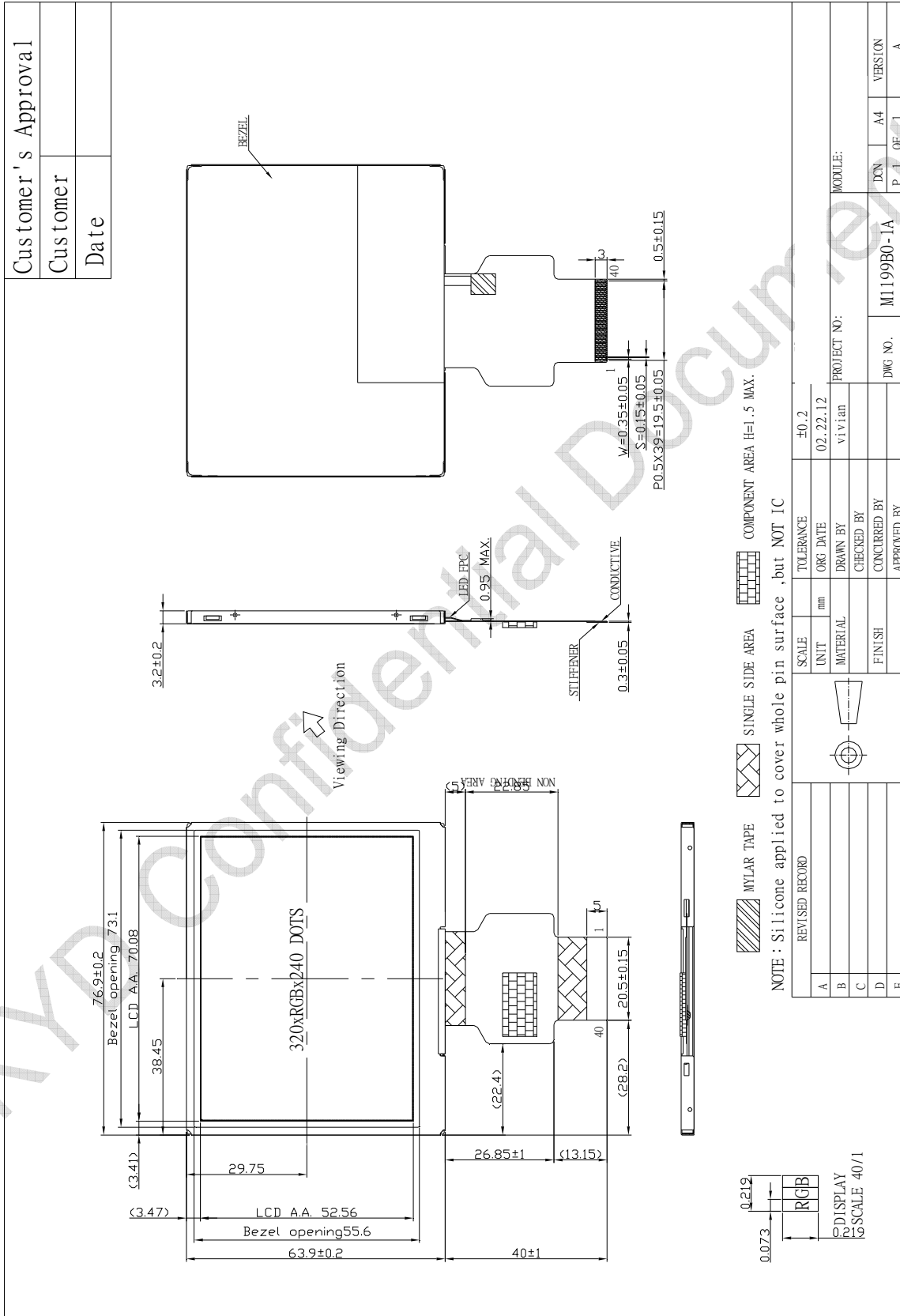



KYOCERA Display Corporation

5. MAXIMUM RATINGS

ITEM	SYMBOL	MIN.	MAX.	UNIT	NOTE
Power Supply Voltage	VCI	-0.3	+4.6	V	Note2
Power Supply Voltage	VDD	-0.3	+4.6	V	Note2
Operation Temperature	T _{op}	-20	70	°C	
Storage Temperature	T _{stg}	-30	80	°C	
Humidity	-	-	90	%RH	Note1

Note1: T_A ≤ 40°C Without dewing

Note2:

- a. All of voltage listed above are with respect to GND=VSS=0V.
- b. Device is subject to be damaged permanently if stresses beyond those absolute maximum ratings listed above.

6. ELECTRICAL CHARACTERISTICS

6.1.TFT LCD Characteristic

Typical operating conditions

(GND=AVSS=0V)

Item	Symbol	Min.	Typ.	Max.	Unit	Note
Power supply	V _{CI}	3.0	3.3	3.6	V	
	IOV _{cc}	1.8	3.3	V _{CI}	V	
Power dissipation	P	-	33	50	mW	
Current dissipation	I	-	10	15	mA	
Driver Input signal voltage	H	V _{IH}	0.7* IOV _{cc}	-	IOV _{cc}	V
	L	V _{IL}	GND	-	0.3* IOV _{cc}	V
Driver output signal voltage	H	V _{OH}	0.8* IOV _{cc}	-	IOV _{cc}	V
	L	V _{OL}	GND	-	0.2* IOV _{cc}	V

6.2.Backlight Characteristic

Item	Symbol	Values			Unit	Remark
		Min.	Typ.	Max.		
LED Current	I _L	---	20	---	mA	
LED Voltage	V _L	16.8	---	21.0	V	
Power dissipation	P _L		400		mW	

Note: KYOCERA DISPLAY suggests using constant current driving this backlight unit.

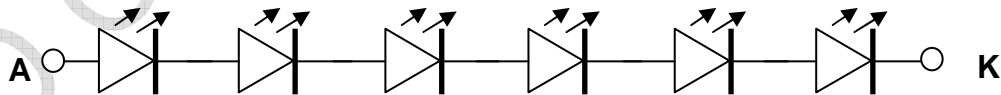



KYOCERA Display Corporation

7. MODULE FUNCTION DESCRIPTION

7.1.PIN Description

Pin	Symbol	Function	Remark
1	NC	NC	
2	NC	NC	
3	NC	NC	
4	NC	NC	
5	GND	Power GND	
6	VCI	Analog power (3.3V)	
7	VCI	Analog power (3.3V)	
8	IOVcc	IO Power(3.3V)	
9	GND	Power GND	
10	/RESET	Reset	
11	nCS	SPI Chip select	
12	SCL	SPI Clock	
13	SDO	SPI data output Leave the pin to open when not in use.	
14	SDA	SPI data input	
15	GND	Power GND	
16	D7	Data input D7 (MSB)	
17	GND	Power GND	
18	D6	Data input D6	
19	GND	Power GND	
20	D5	Data input D5	
21	GND	Power GND	
22	D4	Data input D4	
23	GND	Power GND	
24	D3	Data input D3	
25	GND	Power GND	
26	D2	Data input D2	
27	GND	Power GND	
28	D1	Data input D1	



KYOCERA Display Corporation

29	GND	Power GND	
30	D0	Data input D0 (LSB)	
31	GND	Power GND	
32	CLK	Pixel Clock signal	
33	GND	Power GND	
34	HSYNC	Horizontal Sync Input signal	
35	VSYNC	Vertical Sync Input signal	
36	DE	Data enable signal Fix to GND level when not in use.	
37	LED_K2	Backlight Power (-)	
38	LED_K1	Backlight Power (-)	
39	LED_A2	Backlight Power (+)	
40	LED_A1	Backlight Power (+)	



KYOCERA Display Corporation

7.2. Timing characteristics

7.2.1. 8-bits serial RGB interface

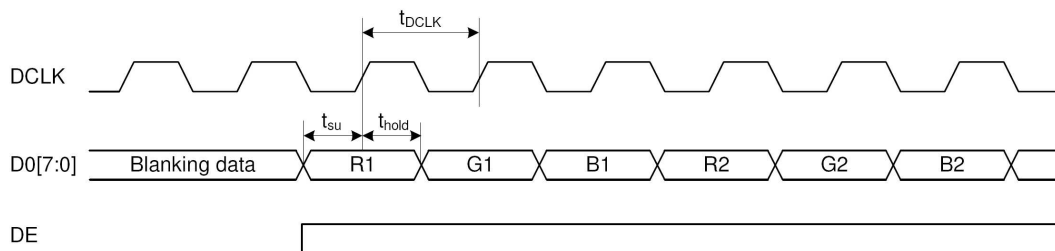
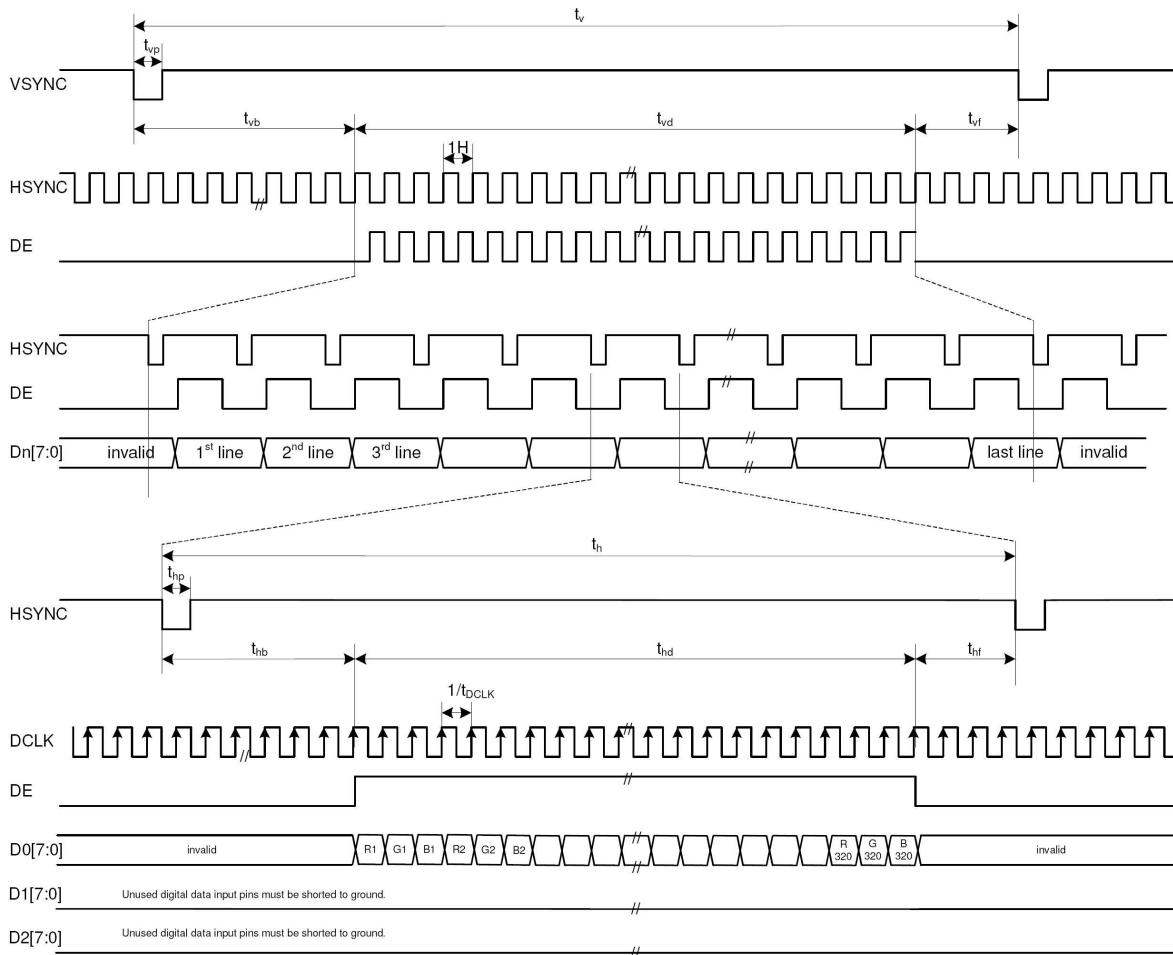



KYOCERA Display Corporation

Parameter	Symbol	Min.	Typ.	Max.	Unit.	Note
DCLK Frequency	$1/t_{DCLK}$	-	24.535	-	MHZ	
Horizontal Period	t_h	-	1560	-	t_{DCLK}	
Horizontal Display Period	t_{hd}	960	960	960	t_{DCLK}	
Horizontal Back Porch	t_{hb}	-	241	-	t_{DCLK}	
Horizontal Front Porch	t_{hf}	16	359	-	t_{DCLK}	
Horizontal Pulse Width	t_{hp}	1	1	-	t_{DCLK}	
Vertical Period	t_v	-	262	-	t_h	
Vertical Display Period	t_{vd}	240	240	240	t_h	
Vertical Back Porch	t_{vb}	2	18	-	t_h	
Vertical Front Porch	t_{vf}	1	4	-	t_h	
Vertical Pulse Width	t_{vp}	1	1	-	t_h	
Data setup time	t_{su}	12	-	-	ns	
Data hold time	t_{hold}	12	-	-	ns	

7.2.2.SPI

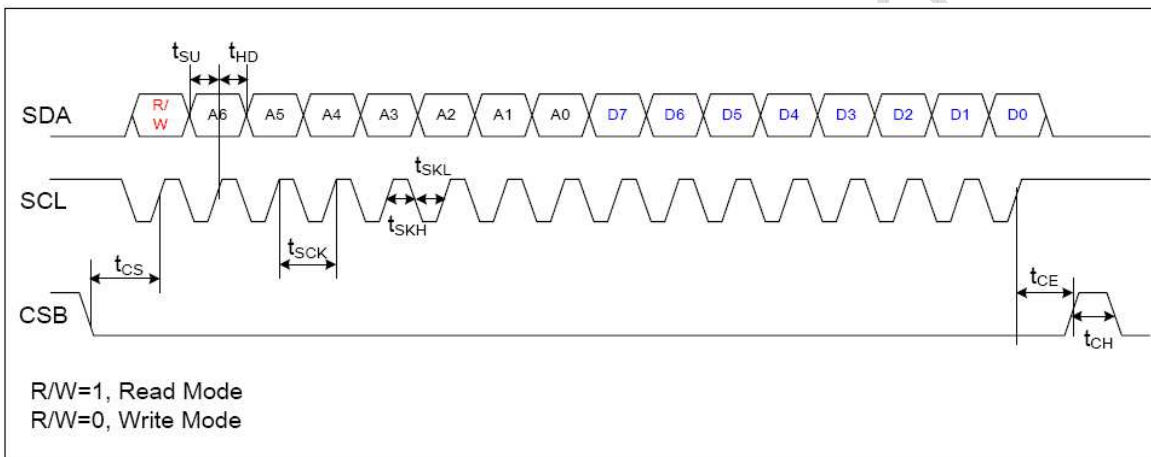

Items	Symbol	Min.	Typ.	Max.	Unit	Note
CSB to SCL Setup time	T_{CS}	50	-	-	ns	
CSB to SCL Hold time	T_{CE}	50	-	-	ns	
SCL Period	T_{SCK}	50	-	-	ns	
SCL High Period	T_{SKH}	25	-	-	ns	
SCL Low Period	T_{SKL}	25	-	-	ns	
Data Setup Time	T_{SU}	15	-	-	ns	
Data Hold Time	T_{HD}	15	-	-	ns	
CSB High Pulse Period	T_{CH}	50	-	-	ns	



KYOCERA Display Corporation

Power ON sequence

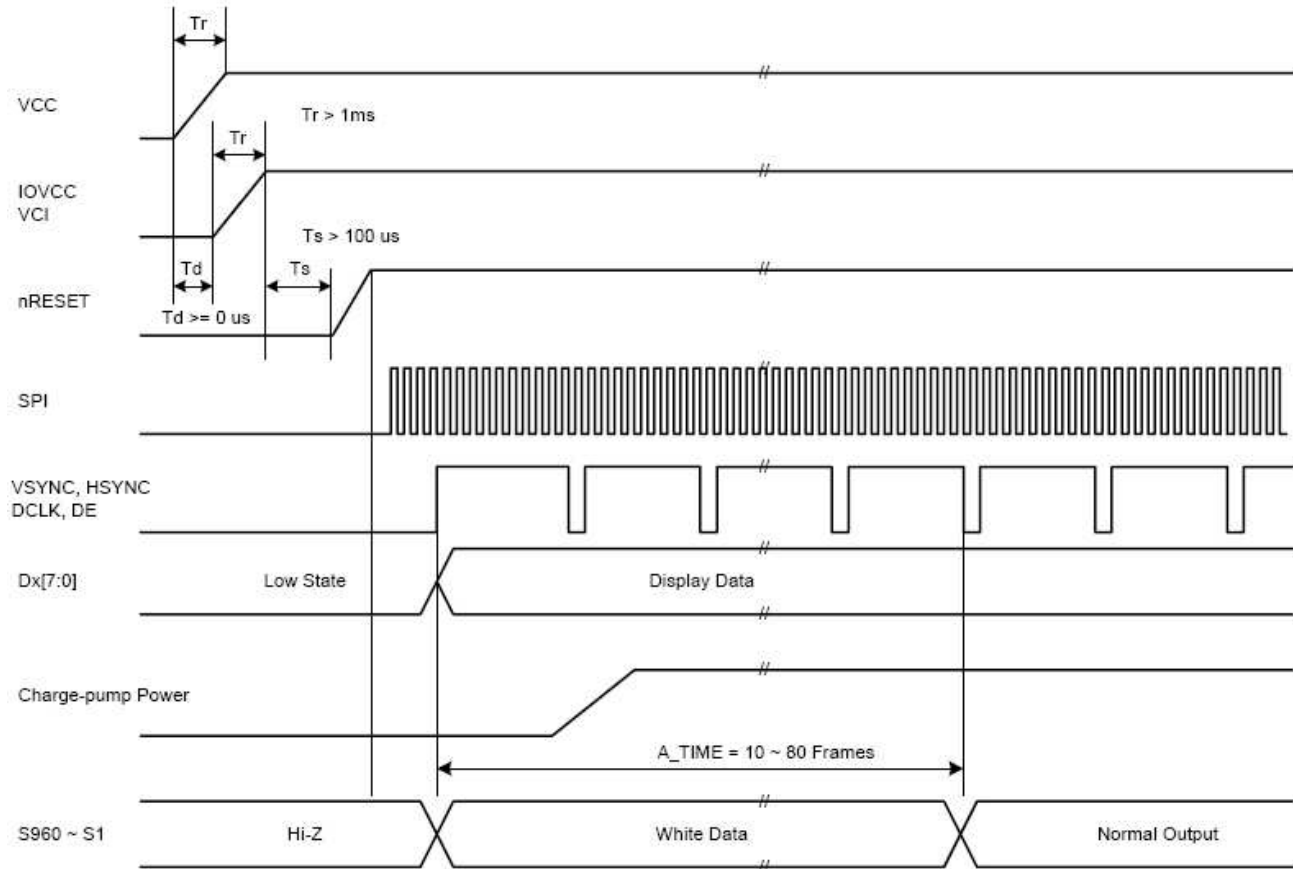

KYD Confide



KYOCERA Display Corporation

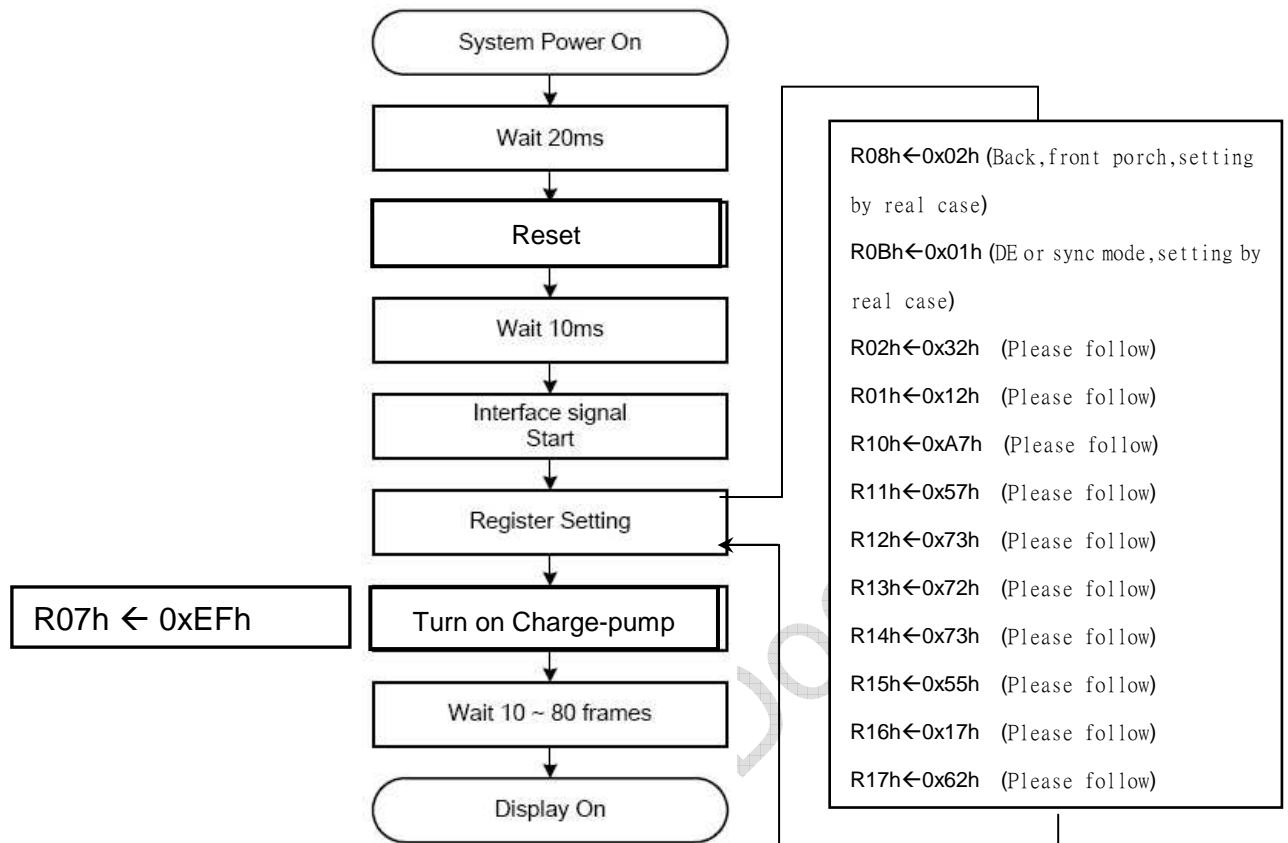

Power OFF sequence

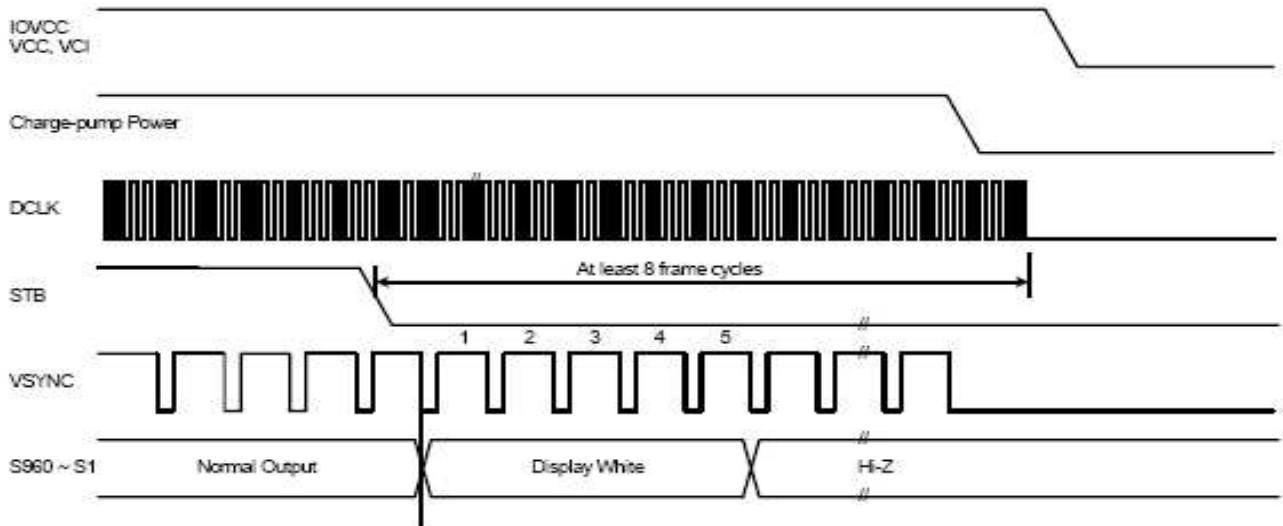

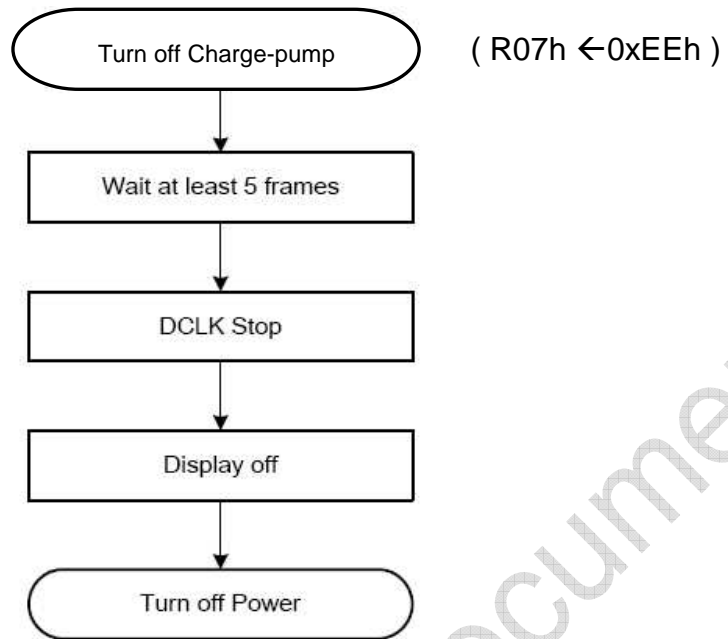

Stand by sequence

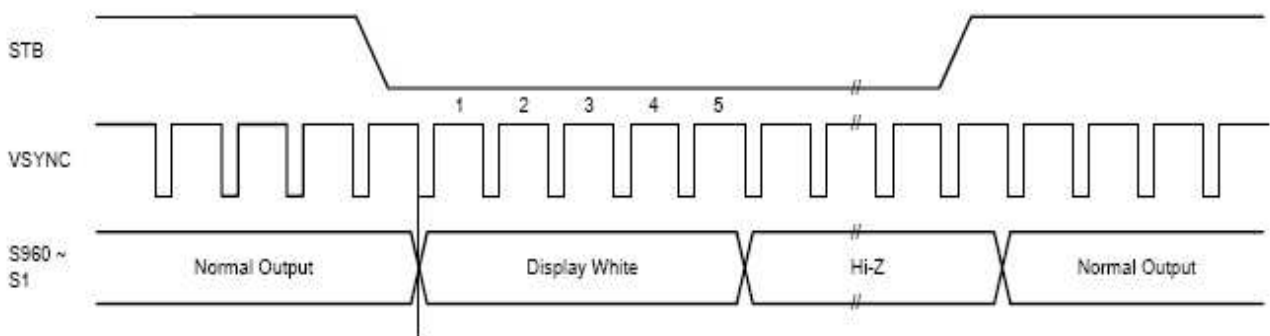



KYOCERA Display Corporation

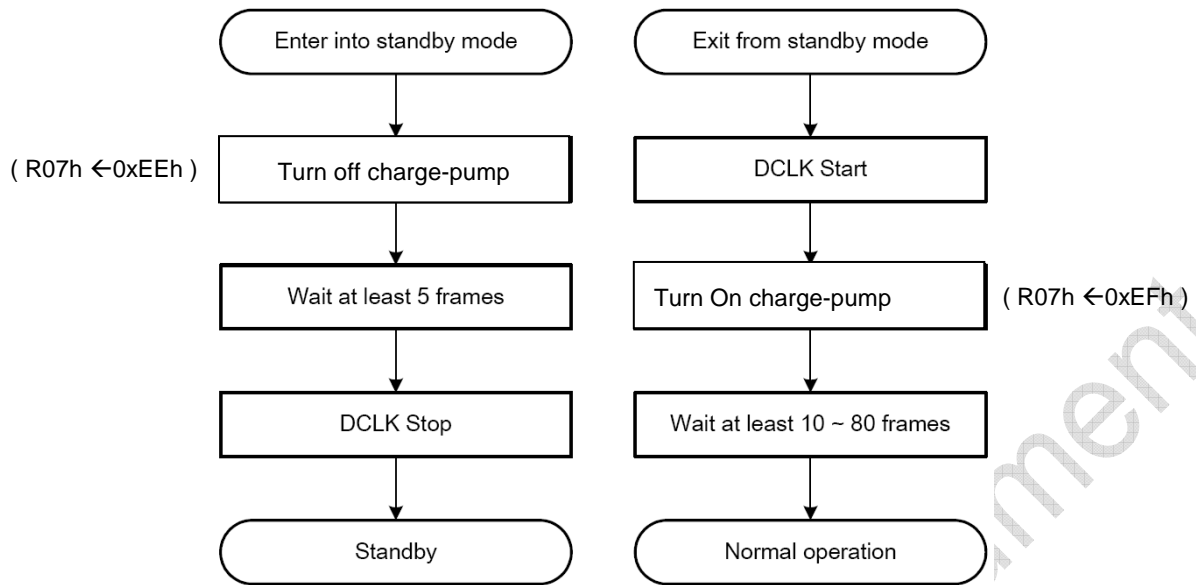

8. ELECTRO-OPTICAL CHARACTERISTICS

The following items are measured under stable conditions. The optical characteristics should be measured in dark room or equivalent state with the methods shown in Note 1.

Item	Symbol	Condition	Min	Typ	Max	Unit	Remark
Brightness	L	-	250	280	---	cd/m ²	
Response time	T _R +T _F	Θ=0	---	25	---	ms	Note 2
Contrast ratio	CR	At the center point of A.A.	250	300	-	-	Note 3



KYOCERA Display Corporation

Color Chromaticity	White	W_x	$\Theta = 0^\circ$	(0.29)	(0.34)	(0.39)	-	Note 4
		W_y	$\Phi = 0^\circ$	(0.28)	(0.33)	(0.38)		
	Red	W_x	$\Theta = 0^\circ$	(0.59)	(0.64)	(0.69)		
		W_y	$\Phi = 0^\circ$	(0.30)	(0.35)	(0.40)		
	Green	W_x	$\Theta = 0^\circ$	(0.35)	(0.40)	(0.45)		
		W_y	$\Phi = 0^\circ$	(0.51)	(0.56)	(0.61)		
	Blue	W_x	$\Theta = 0^\circ$	(0.10)	(0.15)	(0.20)		
		W_y	$\Phi = 0^\circ$	(0.04)	(0.09)	(0.14)		
Viewing Angle	Horizontal	3"	CR \square 10	55	60	-	Degree	Note 5
		9"		55	60	-		
	Vertical	12"		55	55	-		
		6"		40	60	-		

Ta=25±2°C

Note:

1. Test equipment setup

After stabilizing and leaving the panel alone at a given temperature for 30 minutes, the measurement should be executed. Measurement should be executed in a stable, windless, and dark room. Optical specifications are measured by Topcon BM-7(fast) with a viewing angle of 2° at a distance of 50cm and normal direction.

2. Definition of response time: T_R and T_F

The figure below is the output signal of the photo detector.

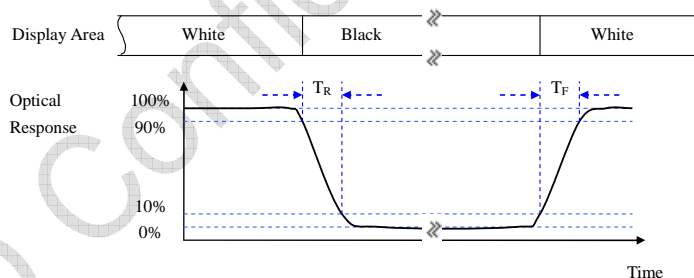

3. Definition of contrast ratio:

$$\text{Contrast ratio (CR)} = \frac{\text{Brightness measured when LCD is at "white state"}}{\text{Brightness measured when LCD is at "black state"}}$$

White $V_i = V_{i50\%} \pm 1.5V$

Black $V_i = V_{i50\%} \mp 2.0V$

"±" means that the analog input signal swings in phase with VCOM signal.

"∓" means that the analog input signal swings out of phase with VCOM signal.

$V_{i50\%}$: The analog input voltage when transmission is 50%.

The 100% transmission is defined as the transmission of LCD panel when all the input



KYOCERA Display Corporation

terminals of module are electrically opened.

4. Measured at the center area of the panel when all the input terminals of LCD panel are electrically opened.

5. Definition of viewing angle:

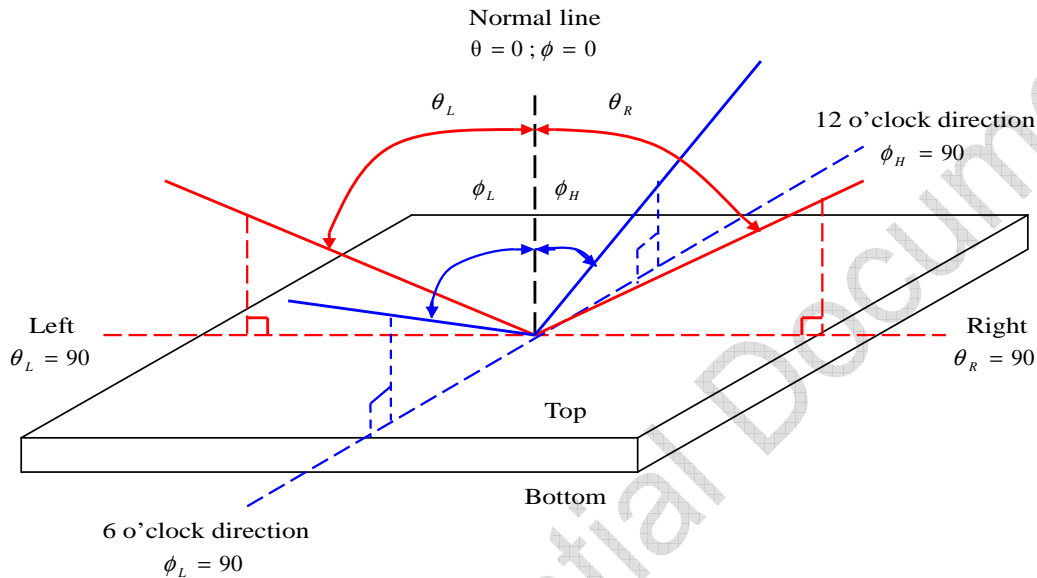

9. APPLICATION NOTE

9.1. Suggestion of SPI code

Register No.	Setting value	Description
08h	02h	Vertical Back Porch
0Bh	01h	Set line inversion Set RGB I/F signal HSYNC+VSYNC mode
02h	32h	Set the VCOMH voltage from 0.87 x VREG1OUT.



KYOCERA Display Corporation

01h	12h	Set the amplitude of Vcom alternating voltage be 1.06 x VREG1OUT.
10h	A7h	Set Neg_Gamma 1, Pos_Gamma 1
11h	57h	Set Neg_Gamma 2, Pos_Gamma 2
12h	73h	Set Neg_Gamma 3, Pos_Gamma 3
13h	72h	Set Neg_Gamma 4, Pos_Gamma 4
14h	73h	Set Neg_Gamma 5, Pos_Gamma 5
15h	55h	Set Neg_Gamma 6, Pos_Gamma 6
16h	17h	Set Neg_Gamma 7, Pos_Gamma 7
17h	62h	Set Neg_Gamma 8, Pos_Gamma 8

Note:

Interface Control (R0Bh)

R/W	D7	D6	D5	D4	D3	D2	D1	D0
W	0	0	0	0	RGBIF[1]	RGBIF[0]	0	F/L

F/L	Function
0	Frame inversion.
1	Line Inversion. (default)

RGBIF[1:0]	Function
00	HSYNC+VSYNC Mode
01	HSYNC+VSYNC+DE Mode
10	DE Only Mode
11	Setting disabled

10.RELIABILITY

10.1.MTTF

The LCD module shall be designed to meet a minimum MTTF value of 50,000 hours with normal condition. (25°C in the room without sunlight; not include life time of backlight)

10.2.TESTS

NO.	ITEM	CONDITION	CRITERION
1	High Temperature Operating	70°C 240 hrs	◦ No Defect Of Operational Function In



KYOCERA Display Corporation

2	Low Temperature Operating	-20°C 240 hrs	Room Temperature Are Allowable(23±5°C).
3	High Temperature/ Humidity Non-Operating	60°C ,90%RH ,240 hrs	
4	High Temperature Non-Operating	80°C 240 hrs	
5	Low Temperature Non-Operating	-30°C 240 hrs	
6	Temperature Shock Non-Operating	-30°C ←→ 80°C (30min) (5min) (30min) 10 CYCLES	
7	Electro-static Discharge	HBM : ±2kv	

Note 1: Test after 24 hours in room temperature(23±5°C).

Note 2: The sampling above is individually for each reliability testing condition.

Note 3: The color fading of polarizing filter should not care.

Note 4: All of the reliability testing chamber above, is using D.I. water. (Min value: 1.0 MΩ -cm)

Note 5: In case of malfunction defect caused by ESD damage, if it would be recovered to normal state after software resetting, it would be judged as a good part.

10.3.Color performance

No.	ITEM	Criterion (initial)
1	Luminance	>50%
2	NTSC	>70%
3	Contrast Ratio	>50%

11.INSPECTION CRITERIA

11.1.Inspection Conditions

11.1.1.Environmental conditions

The environmental conditions for inspection shall be as follows

Room temperature: 23±5°C

Humidity: 50±20%RH

11.1.2.The external visual inspection

With a single 1000±200lux fluorescent lamp as the light source, the inspection

was in the distance of 30cm or more from the LCD to the inspector's eyes.

11.2. Light Method

11.2.1. Environment lamp under 1000 ± 200 lux, Viewing direction for inspection over

30 cm

11.2.2. The distance from eye to defect around 300mm, the distance from ND Filter to

defect around 25~30mm

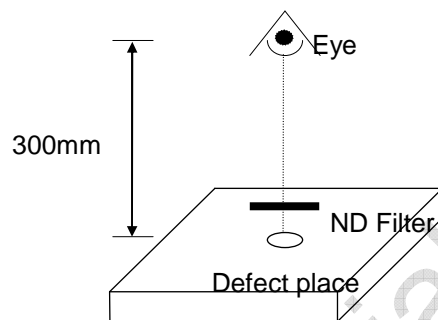

11.3. Classification Of Defects

11.3.1. Major defect

A major defect refers to a defect that may substantially degrade usability for product applications.

11.3.2. Minor defect

A minor defect refers to a defect which is not considered to be able substantially degrade the product application or a defect that deviates from existing standards almost unrelated to the effective use of the product or its operation.

Notes: If the LCD/LCM's cosmetic and display performance do not specify in "inspection criterion", it should be based on these delivered samples.

11.4. Sampling & Acceptable Quality Level

Level II, MIL-STD-105E

	Major	Minor
Cosmetic	1.0 %	1.5 %

Electrical-display	0.4%	0.65 %
--------------------	------	--------

11.5. Definition Of Inspection Area

V.A: Viewing Area

A.A: Active Area

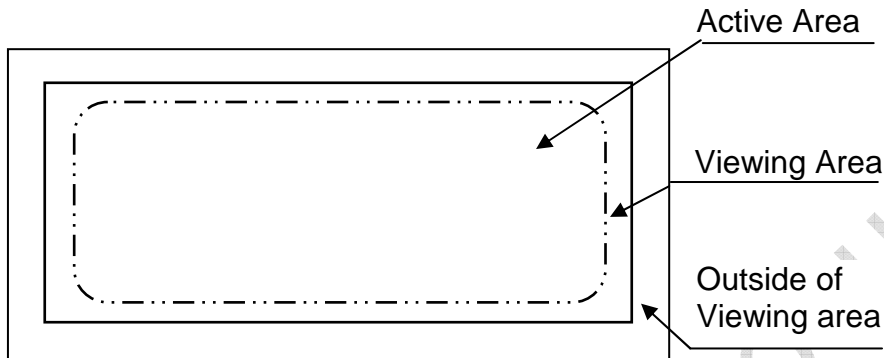

11.6. Items and Criteria

11.6.1. Visual inspection criterion in cosmetic

(1) Glass defect

No	Defect	Criteria	Remark
1	Dimension (Minor)	By engineering diagram	<p>The diagram shows a rectangular display panel with dimensions X, Y, and Z. X is the width, Y is the height, and Z is the thickness of the panel.</p>
2	Cracks (Major)	Extensive crack 【Reject】	<p>The image shows a display panel with a red line indicating a crack on the surface.</p>

(2) LCM appearance defect within A.A

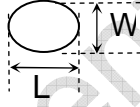
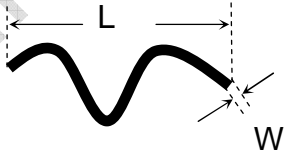
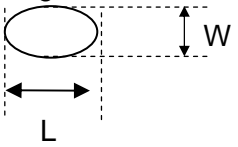
No	Defect	Criteria		Remark
1	Round type (Minor)	Spec.	Permissible Qty	1. $\psi = (L+W)/2$, L: Length, W: Width 2. Disregard if out of A.A. 
		$\psi \leq 0.10\text{mm}$	Disregard	
		$0.10\text{mm} < \psi \leq 0.20\text{mm}$	3	
		$0.20\text{mm} < \psi$	0	
2	Line type (Minor)	Spec.	Permissible Qty	1. L: Length, W: Width 2. Disregard if out of A.A. 
		$W \leq 0.03\text{mm}$	Disregard	
		$L \leq 3.0\text{mm}$ and $0.03\text{mm} < W \leq 0.05\text{mm}$	2	
		$L \leq 3.0\text{mm}$ and $0.05\text{mm} < W \leq 0.10\text{mm}$	1	
	$W > 0.10\text{mm}$ or $L > 3.0\text{mm}$	0		
3	Polarizer Bubble/dent (Minor)	Spec.	Permissible Qty	1. $\psi = (L+W)/2$, L: Length, W: Width 2. Disregard if out of A.A. 
		$\psi \leq 0.20\text{mm}$	Disregard	
		$0.20\text{mm} < \psi \leq 0.30\text{mm}$	2	
		$0.30\text{mm} < \psi \leq 0.50\text{mm}$	1	
	$0.50\text{mm} < \psi$	0		

(3) FPC

No	Defect	Criteria		Remark
1	Copper peeling (Minor)	Copper peeling	【Reject】	

(4) Black tape

No	Defect	Criteria		Remark
1	Shift (Minor)	IC exposed	【Reject】	
2	No black tape (Minor)	No black tape	【Reject】	

(5) Silicon



KYOCERA Display Corporation

No	Defect	Criteria	Remark
1	Amount of silicon (Minor)	ITO exposed 【Reject】	

(6) Bezel

No	Defect	Criteria	Remark
1	Oxidized spot (Minor)	Oxidized spot, rust 【Reject】	
2	Outline deformation (Minor)	By engineering diagram	
3	Greasiness (Minor)	Greasiness 【Reject】	
4	Spots, round Type (Minor)	$H \leq$ By engineering diagram 【Disregard】	H=Total height (thickness)
5	Plating (Minor)	Bubble, peeling 【Reject】	

(7) Power cord

No	Defect	Criteria	Remark
1	Power cord (Minor)	Power core loose	

11.6.2. Visual inspection criterion in electrical display

LCM electrical criterion

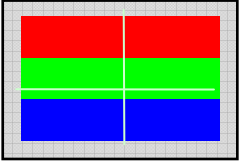
No	Defect	Criteria	Remark
1	No display (Major)	Not allowed	
2	Missing line (Major)	Not allowed	

3	Darker or lighter line (Major)	Not allowed		
4	Bright / Dark point (Minor)	Spec.	Permissible Qty	1:1sub-pixel: 1R or 1G or 1B 2:Point defect area $\geq 1/2$ sub pixel.
		Bright point	1	
		Dark point	2	
5	Round type (Minor)	Spec.	Permissible Qty	1. $\psi = (L+W)/2$, L: Length, W: Width 2. Disregard if out of A.A.
		$\psi \leq 0.10\text{mm}$	Disregard	
		$0.10\text{mm} < \psi \leq 0.20\text{mm}$	3	
		$0.20\text{mm} < \psi$	0	
6	Line type (Minor)	Spec.	Permissible Qty	1. L: Length, W: Width 2. Disregard if out of A.A.
		$W \leq 0.03\text{mm}$	Disregard	
		$L \leq 3.0\text{mm}$ and $0.03\text{mm} < W \leq 0.05\text{mm}$	2	
		$L \leq 3.0\text{mm}$ and $0.05\text{mm} < W \leq 0.10\text{mm}$	1	
		$W > 0.10\text{mm}$ or $L > 3.0\text{mm}$	0	
7	Mura (Minor)	By 5% ND filter invisible		

Note1 : Issues that are not defined in this document shall be discussed and agreed with both parties. (Customer and supplier)

Note2 : Unless otherwise agreed upon in writing, the criteria shall be applied to both parties. (Customer and supplier)

12. RoHS COMPLIANT WARRANTY

RoHs Hazardous substances including:

- Cd < 100 ppm
- Pb < 1000 ppm
- Hg < 1000 ppm
- Cr +6 < 1000 ppm



KYOCERA Display Corporation

- PBDE < 1000 ppm
- PBB < 1000 ppm

13. PRECAUTIONS FOR USE

13.1. Safety

- (1) Do not swallow any liquid crystal, even if there is no proof that liquid crystal is poisonous.
- (2) If the LCD panel breaks, be careful not to get liquid crystal to touch your skin.
- (3) If skin is exposed to liquid crystal, wash the area thoroughly with alcohol or soap.

13.2. Storage Conditions

- (1) Store the panel or module in a dark place where the temperature is $23\pm 5^{\circ}\text{C}$ and the humidity is below $50\pm 20\%\text{RH}$.
- (2) Store in anti-static electricity container.
- (3) Store in clean environment, free from dust, active gas, and solvent.
- (4) Do not place the module near organics solvents or corrosive gases.
- (5) Do not crush, shake, or jolt the module.
- (6) Do not expose to direct sun light of fluorescent lamps.

13.3. Installing LCD Module

Attend to the following items when installing the LCM.

- (1) Cover the surface with a transparent protective plate or touch panel to protect the polarizer and LC cell.
- (2) When assembling the LCM into other equipment, the spacer to the bit between the LCM and the fitting plate should have enough height to avoid causing stress to the module surface, refer to the individual specifications for measurements. The measurement tolerance should be $\pm 0.1\text{mm}$.

13.4. Precautions for Operation

- (1) Viewing angle varies with the change of liquid crystal driving voltage (V_0). Adjust V_0 to show the best contrast.
- (2) Driving the LCD in the voltage above the limit will shorten its lifetime.
- (3) Response time is greatly delayed at temperature below the operating temperature range. However, this does not mean the LCD will be out of the order. It will recover when it returns to the specified temperature range.



KYOCERA Display Corporation

- (4) When turning the power on, input each signal after the positive/negative voltage becomes stable.
- (5) Do not apply water or any liquid on product, which composed of LCM.

13.5.Handling Precautions

- (1) Avoid static electricity that can damage the CMOS LSI; please wear the wrist strap when handling.
- (2) The polarizing plate of the display is very fragile. so, please handle it very carefully.
- (3) Do not give external shock.
- (4) Do not apply excessive force on the surface; it may cause display abnormal.
- (5) Do not wipe the polarizing plate with a dry cloth, as it may easily scratch the surface of plate.
- (6) Do not use ketenes solvent & Aromatic solvent, use with a soft cloth soaked with a cleaning naphtha solvent.
- (7) Do not operate it above the absolute maximum rating.
- (8) Do not remove the panel or frame from the module.
- (9) Do not apply water or any liquid on product, which composed of LCM.

13.6.Warranty

- 13.6.1. The period is within 12 months since the date of shipping out under normal using and storage conditions.
- 13.6.2.The warranty will be avoided in case of defect induced by customer.

14.REVISION HISTORY

Version	Revise record	Date
A	New version	2012/02/22
B	Move With T/P, 1.General description(page5), 8. Electro-optical characteristics (page16), &	2012/03/01



KYOCERA Display Corporation

	14.Precautions for use (page27),	
C	Viewing Direction remark	2012/04/24
	Type No. Change 55733D035 →55733GD035	2012/04/24

KYD Confidential Document