

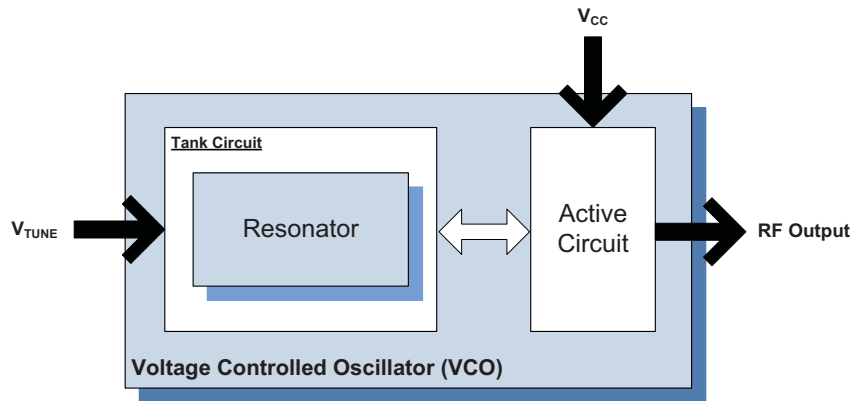

Features

- Linear Tuning/100MHz Frequency
- Frequency: 3000MHz to 3100MHz
- Resonator: Microstrip
- PCB: Rogers
- Package Size: 12.7mm x 12.7mm x 4.57mm (0.5in x 0.5in x 0.18in)



Functional Block Diagram

Applications

- Frequency Synthesizers
- Upconverters and Downconverters
- Narrow V_{TUNE} and V_{CC} Applications

Product Description

This series of VCO modules offers ultra-linear tuning across their specified frequency band.

Ordering Information

UMV-3050-R16-G Contact us at 1-480-756-6070

Optimum Technology Matching® Applied

- | | | | |
|--------------------------------------|--------------------------------------|--------------------------------------------|------------------------------------|
| <input type="checkbox"/> GaAs HBT | <input type="checkbox"/> SiGe BiCMOS | <input type="checkbox"/> GaAs pHEMT | <input type="checkbox"/> GaN HEMT |
| <input type="checkbox"/> GaAs MESFET | <input type="checkbox"/> Si BiCMOS | <input type="checkbox"/> Si CMOS | <input type="checkbox"/> BiFET HBT |
| <input type="checkbox"/> InGaP HBT | <input type="checkbox"/> SiGe HBT | <input checked="" type="checkbox"/> Si BJT | <input type="checkbox"/> LDMOS |

RF MICRO DEVICES®, RFMD®, Optimum Technology Matching®, Enabling Wireless Connectivity™, PowerStar®, POLARIS™ TOTAL RADIO™ and UltimateBlue™ are trademarks of RFMD, LLC. BLUETOOTH is a trademark owned by Bluetooth SIG, Inc., U.S.A. and licensed for use by RFMD. All other trade names, trademarks and registered trademarks are the property of their respective owners. ©2006, RF Micro Devices, Inc.

Absolute Maximum Ratings

Parameter	Rating	Unit
Operating Ambient Temperature[1]	-40 to +85	°C
Storage Temperature	-55 to +125	°C

[1] Frequency drift: 9MHz typical (either extreme)



Caution! ESD sensitive device.

Exceeding any one or a combination of the Absolute Maximum Rating conditions may cause permanent damage to the device. Extended application of Absolute Maximum Rating conditions to the device may reduce device reliability. Specified typical performance or functional operation of the device under Absolute Maximum Rating conditions is not implied.

The information in this publication is believed to be accurate and reliable. However, no responsibility is assumed by RF Micro Devices, Inc. ("RFMD") for its use, nor for any infringement of patents, or other rights of third parties, resulting from its use. No license is granted by implication or otherwise under any patent or patent rights of RFMD. RFMD reserves the right to change component circuitry, recommended application circuitry and specifications at any time without prior notice.



RoHS (Restriction of Hazardous Substances): Compliant per EU Directive 2002/95/EC.

Parameter	Specification			Unit	Condition
	Min.	Typ.	Max.		
Overall					
Frequency Range	3000		3100	MHz	
Tuning Voltage	0.5		4.5	V _{DC}	
Tuning Sensitivity		40		MHz/V	
Output Power	-2.5	0	2.5	dBm	
	-3				At V _T = 0
Output Phase Noise		-75	-70	dBc/Hz	1 kHz
		-102	-97	dBc/Hz	10 kHz
		-122	-117	dBc/Hz	100 kHz
		-142	-137	dBc/Hz	1000 kHz
		-162	-155	dBc/Hz	10000 kHz
Second Harmonic		-15	-10	dBc	
Frequency Pulling		1	2	MHz p-p	At 12dB _r , all phases
Tuning Port Capacitance		20		pF	
Modulation Bandwidth		1000		kHz	3dB BW
Frequency Pushing		1.5	3	MHz/V	
Power Supply					
Operating Voltage		5		V	
Supply Current		28		mA	

Package Drawing & Pin Outs

12.7mm x 12.7mm x 4.57mm (0.5in x 0.5in x 0.18in)

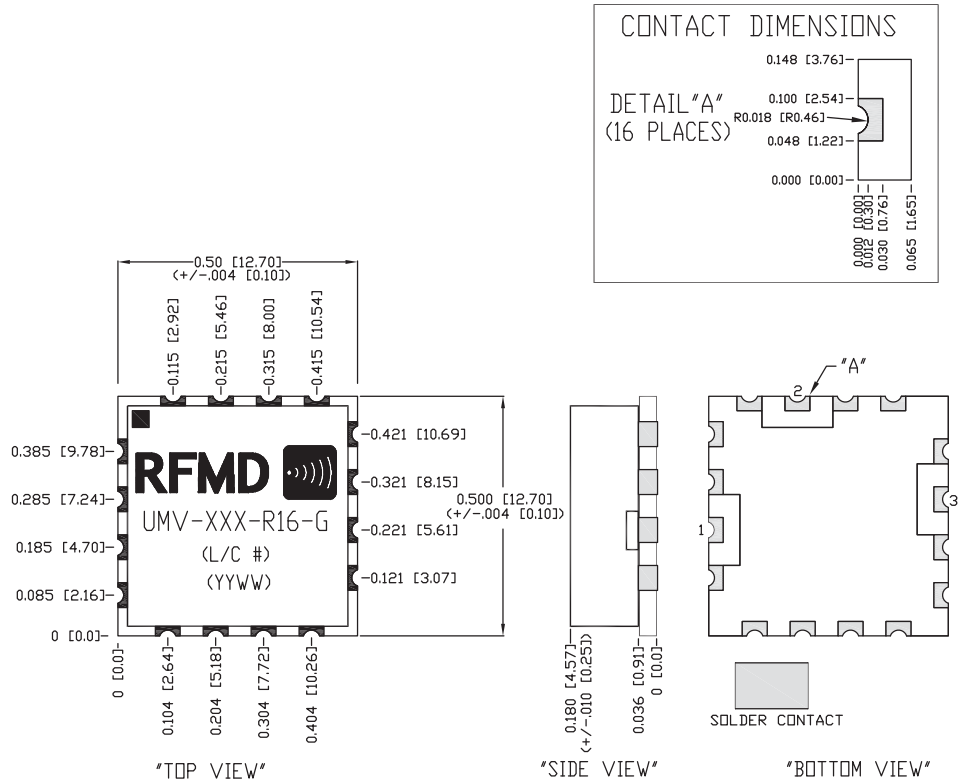

CONTACT ASSIGNMENTS:	
1:	RF OUT
2:	SUPPLY INPUT
3:	TUNING VOLTAGE INPUT
ALL OTHER CONTACTS ARE GROUND	