

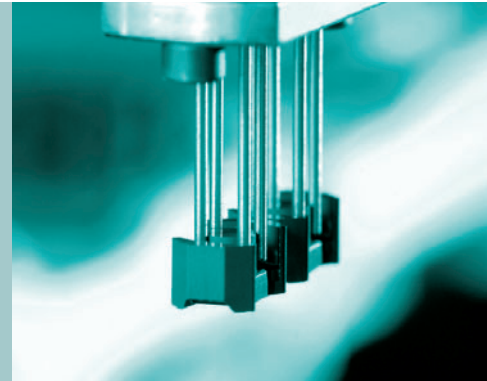

Product Profile 2006

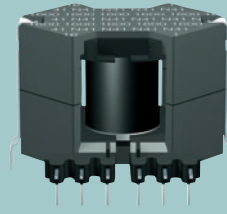
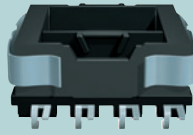
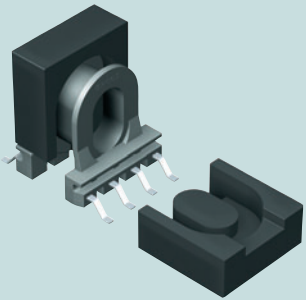

Ferrites and Accessories Ferrite und Zubehör

just everywhere ...

www.epcos.com

Welcome to the World of Passive Electronic Components

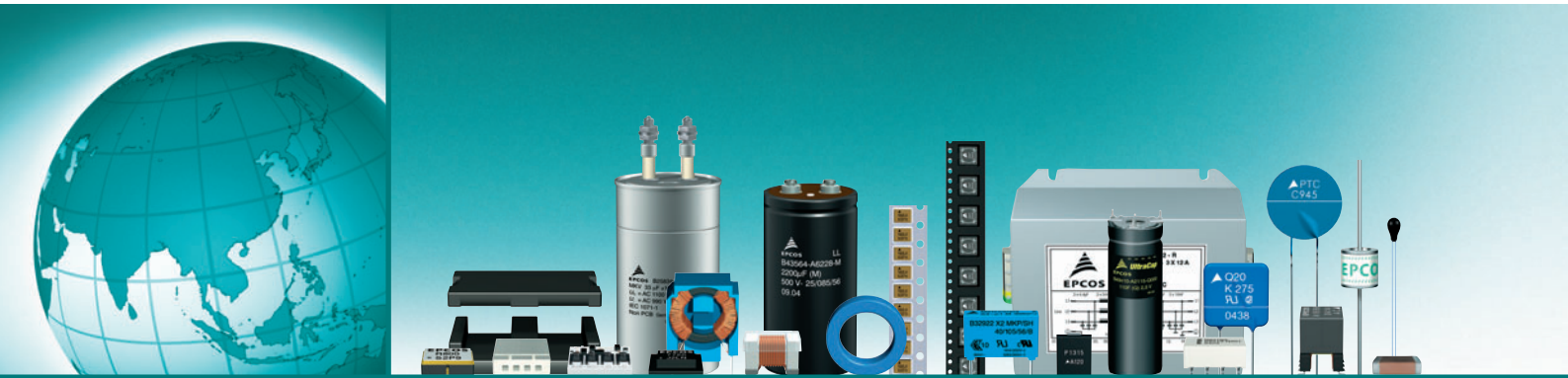

Active everywhere

Passive electronic components are found in every electrical and electronic product – from automotive and industrial electronics through information and communications to consumer electronics. These key components are needed to store electrical energy, select frequencies, and protect against overvoltage and overcurrent. With a portfolio of 40,000 different products and a global presence, we are market leader in Europe and number two worldwide among manufacturers of passive electronic components.

Überall aktiv

Passive elektronische Bauelemente befinden sich in nahezu jedem elektrischen und elektronischen Gerät – von der Industrie- und Automobil-Elektronik über die Informations- und Kommunikationstechnik bis hin zur Konsum-Elektronik. Als Schlüsselbauelemente werden sie benötigt, um elektrische Signale zu verarbeiten, elektronische Schaltungen zu schützen und die Energieversorgung zu sichern. Mit rund 40.000 Produkten und unserer weltweiten Präsenz sind wir als Hersteller von passiven elektronischen Bauelementen Marktführer in Europa und weltweit die Nummer Zwei.

Ferrites and Accessories

Ferrite und Zubehör

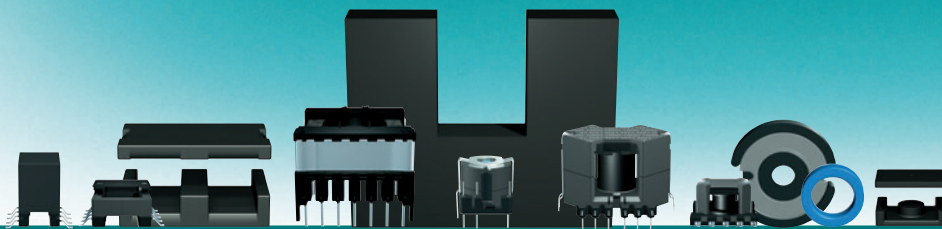

Contents / Inhalt

■ Vorwort	■ Preview	4
■ Werkstoffe	■ Materials	6
Produkte für Telekommunikation und Datenverarbeitung	Products for telecommunications and data processing	
■ RM-Kerne	■ RM cores	8
■ Low-Profile RM-Kerne	■ Low-profile RM cores	10
■ P-Kerne	■ P cores	14
■ TT-/PR-Kerne	■ TT/PR cores	18
■ EP-Kerne	■ EP cores	20
■ EPX-/EPO-Kerne	■ EPX/EPO cores	22
Produkte für Industrie-Anwendungen	Products for industrial applications	
■ Einzelschalen	■ P core halves	24
■ PM-Kerne	■ PM cores	26
■ U-/I-Kerne	■ U/I cores	28
Produkte für Stromversorgungen und Leuchtentechnik	Products for power supplies and lighting technology	
■ E-Kerne	■ E cores	30
■ ELP-/EQ-/I-Kerne	■ ELP/EQ/I cores	36
■ ETD-Kerne	■ ETD cores	38
■ ER-Kerne	■ ER cores	40
■ EFD-/EV-Kerne	■ EFD/EV cores	42
Produkte für Störschutz-Anwendungen	Products for EMI suppression applications	
■ Ringkerne	■ Toroids	44
■ Symbole und Begriffe	■ Symbols and terms	50
■ Wichtige Hinweise	■ Important notes	51
■ Adressen	■ Addresses	52

Preview Vorwort

Ferrite sind unverzichtbare Schlüsselkomponenten in vielen modernen Hochleistungstechnologien. Sie finden immer neue Anwendungen in der Unterhaltungs- und Industrie-elektronik sowie der fortschrittlichen Informations- und Kommunikationstechnik.

Und wenn es um Ferrite geht, sind Sie bei uns an der richtigen Adresse: Denn EPCOS gehört zu den führenden Anbietern von Ferriten und Zubehör auf dem Weltmarkt.

Mit innovativen Ferrite-Technologien leisten wir einen entscheidenden Beitrag beim Ausbau unserer Marktführerschaft in Anwendungen der Telekommunikation und Datentechnik. Bei hochpermeablen und Leistungsmaterialien setzen wir neue Maßstäbe.

Mit einem umfangreichen Typenspektrum von Ferritkernen und dem dazu passenden Zubehör bietet EPCOS für alle Anwendungen die optimale Lösung, so dass sich nahezu jeder Lieferwunsch erfüllen lässt.

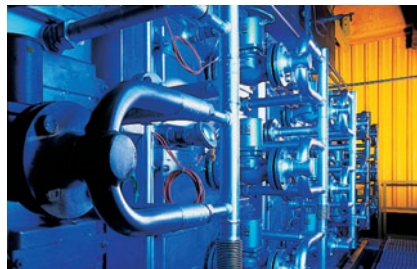

Haubenofen mit computergestützter Sinterführung

Batch kiln with computer-aided sintering control

Davon profitieren Kunden in aller Welt, zu denen führende Hersteller aus der Telekommunikations-, Daten- und Beleuchtungstechnik sowie der

Industrieelektronik gehören. Sie alle setzen auf unsere Kompetenz und Innovationskraft, vertrauen unserer Qualität und Logistik – und sind im Gespräch mit unseren Spezialisten vor Ort.

Nutzen auch Sie unsere Kreativität und Kompetenz für Ihren Erfolg!

Unsere Forschungs- und Entwicklungstätigkeiten messen wir konsequent an den Anforderungen des Marktes und richten sie auf die Wünsche unserer Kunden aus:

Miniaturisierung bei Leistungsmodulen	Reduzierung der Kernverlustleistung, Entwicklung flacher und kleiner Kerne
Gleichstrom-vormagnetisierung	Verbesserung und Neuentwicklung von Materialien mit hoher Sättigung
Access-Anwendungen	Neue Werkstoffe für Breitbandübertrager, Entwicklung optimierter Kernformen
Störschutzanwendungen	Neue Werkstoffe bei erweitertem Kernspektrum
Umweltverträgliche Produkte	Entwicklung bleifreier Oberflächen beim Zubehör, halogenfreie Kunststoffe, Verpackungsoptimierung
Kundenunterstützung	Hohes Applikationsverständnis, Magnetic Design Tool, Time to Market

Ferrites are indispensable key components in many modern, high-performance technologies. They are constantly penetrating new applications in entertainment and industrial electronics, in advanced information and communication technology.

And when it comes to ferrites, you need look no further. Because EPCOS ranks among the leading suppliers of ferrites and accessories on the world market.

With innovative ferrite technologies we are making a decisive contribution to the expansion of our market leadership in telecommunication and data engineering applications. In materials for broadband and power engineering we are setting new standards.

With an extensive range of ferrite cores plus matching accessories, EPCOS is able to offer an optimum solution for every possible application.

Customers all over the world are already profiting from this capability,

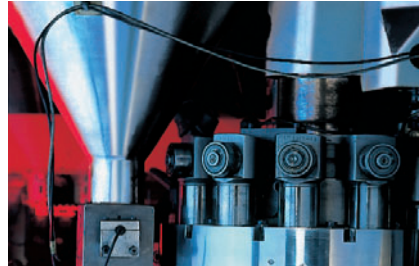

Vollautomatische Rundläuferpresse

Fully automatic rotary press

including leading producers in the telecommunication, computer, lighting and industrial electronics sectors.

They all count on our competence and innovation, trust in our quality and logistics – and know they have support from specialists on the spot.

Make our creativity and competence count for your success too.

Our research and development activities constantly keep pace with the demands of the market, orienting fully on customer needs:

Miniaturization of power modules	Reduction of core losses, development of flat and small cores
DC biasing	Development and improvement of materials with high saturation
Access applications	New materials for broadband transformers, development of optimized core forms
Interference suppression	New materials in expanded core spectrum
Environmentally compatible products	Development of lead-free surfaces in accessories, halogen-free plastics, optimization of packaging
Customer support	High application understanding, Magnetic design tool, Time to market

Materials Werkstoffe

Die Ausgangsmaterialien für Ferrite sind Eisen-, Mangan-, Zink- und Nickeloxide. Aus diesen Grundstoffen entstehen in den Labors von EPCOS mit modernsten Microengineering-Techniken immer neue Ferritmaterialien mit jeweils besonderen Eigenschaften.

In enger Zusammenarbeit mit unseren Kunden passen wir unser Produktspektrum ständig an die Erfordernisse des Marktes an. Dabei werden die Eigenschaften der Ferritwerkstoffe bis an die physikalischen Grenzen ausgelotet.

Die folgenden Tabellen geben einen Überblick über die wichtigsten magnetischen Eigenschaften der EPCOS-Ferritwerkstoffe.



The starting materials for ferrites are iron, manganese, zinc and nickel oxides. From these raw materials EPCOS laboratories, working with the latest microengineering techniques, constantly produce new ferrite materials with their own specific properties.

Cooperating closely with customers, we continuously match our product spectrum to what the market demands. And in doing this, the properties of ferrite materials are sounded to their physical boundaries.

The following tables give an overview of the major magnetic properties of EPCOS ferrite materials.

Anwendungsschwerpunkt: Spulen für Resonanzkreise und Filter Main application: Resonant circuit inductors and filters

tanδ/μ _i level		μ _i	f _{max} (MHz)	T _c (°C)	B _s (mT) 25°C	η _B 10 ⁻⁶ (mT)	Merkmale Features	Hauptanwendungen Main applications	Kernformen Core shapes
low	high								
	K 1	80	12	> 400	310	< 36	Kleiner Verlustfaktor für Filter mit hoher Güte Low loss factor for high-Q filters	UHF Filter, Balun, CATV, HF-Übertrager VHF filters, Balun, CATV, RF transformers	P, RM, Ring / Toroids
	M 33	750	1.0	> 200	400	< 1.8		HF-Übertrager RF transformers	P, RM
	N 48	2300	0.1	> 170	420	< 0.4		HF-Übertrager Filter für Telecom RF transformers Filters for telecom	RM, TT, P
	N 22	2300	0.2	> 145	370	< 1.4		Näherungsschalter Inductive proximity switches	PS
	N 45	3800	0.5	> 255	550	< 0.3		Niedriger η _B /T Hohe Sättigung Low η _B /T High saturation	Filter für Telecom Filters for telecom
K 10		800	1.0	> 150	320	< 5.0	Hohe Impedanz für EMV-Anwendungen High impedance for EMC applications	Leitungs-dämpfung Stromkompensierte Drosseln Line attenuation Current-compensated chokes	Ring / Toroids
K 8		860	0.5	> 150	340	< 4.5			
K 7		1500	0.5	> 110	280	< 4.0			
M 13		2300	0.1	> 105	280	< 4.0			

Anwendungsschwerpunkt: Breitbandübertrager und EMV-Anwendungen
Main application: Broadband transformers and EMC applications

Permeability level		μ_i	f_{max} (kHz)	T_c (°C)	B_s (mT) @ 25°C	η_B 10^{-6} (mT)	Merkmale Features	Hauptanwendungen Main applications	Kernformen Core shapes
low	high								
N 30		4300	400	> 130	380	< 1.1		Stromkomp. Drosseln Current-comp. chokes	RM, P, EP, E, Ring / Toroids
T 57		4000	500	> 190	470	< 0.3	L_{IDC} (0–70 °C), small η_B , high B_s	LAN, DSL	RM, EP, Ring / Toroids
T 65		5200	300	> 160	460	< 1.1	High B_s	HF-Drosseln RF chokes	PR, ER, Ring / Toroids
T 35		6000	200	> 130	390	< 1.1			RM, P, EP, Ring / Toroids
	T 37	6500	350	> 130	380	< 1.1	Small η_B , high B_s ,	Netzfilter Power line filters	P, DE, Ring / Toroids
		T 38	10000	150	> 130	430	high fre- quency bandwidth	DSL, Impedanz- und Anpassungsübertrager	RM, P, EP, ER, Ring / Toroids
		T 66	13000	100	> 100	360		DSL, impedance and matching transformers	RM, P, EP, E
		T 46	15000	20	> 130	400	High μ_i	ISDN-Übertrager ISDN transformers	Ring / Toroids

Anwendungsschwerpunkt: Leistungsübertrager und Drosseln
Main application: Power transformers and chokes

Performance factor		μ_i	f (kHz)	$P_V^{1)}$ (kW/m ³)	$B_s^{2)}$ (mT)	Merkmale Features	Hauptanwendg. Main applications	Kernformen Core shapes
low	high							
N72		2500	25 ... 300	540	370	Flacher Temperaturverlauf Flat power loss vs. temperature	EVG für Energiesparlampen Ballasts for energy- saving lamps	E
	N92	1500	25 ... 500	400	440	Hohe Flussdichte, großer Induktionshub ΔB , kleine Verluste (25 ... 300 kHz) High flux density, large ΔB swing, low losses (25 ... 300 kHz)	Diodenplitting-/ Hochspannungs- Übertrager, Drosseln Diode splitting transformers, High-voltage transformers, chokes	RM, ELP, ER
N 41		2800	25 ... 150	1400	390	Hohe Permeabilität, kleine Verluste (25 ... 100 kHz) bei niedrigen Temperaturen High permeability, low losses (25 ... 100 kHz) at low temperatures	Impulsübertrager Inverter für CCFL ⁴⁾ Pulse transformers Inverters for CCFL ⁴⁾	E, RM, P
N 27		2000	25 ... 150	920	410	Kleine Verluste (25 ... 500 kHz), exzellentes DC-Bias- Verhalten Low losses (25 ... 500 kHz), excellent DC bias behavior	Leistungsübertrager und Drosseln für SNT (MF bis HF) Power transformers and chokes for medium- to high- frequency SMPS	E, ETD, EFD, ER, PM, RM, ELP, EP, TT, PR
	N87	2200	25 ... 500	380	390			
	N97	2300	25 ... 500	300	410			
	N49	1500	300 ... 1000	90 ³⁾	410	Kleine Verluste (0.5 ... 1 MHz) Low losses (0.5 ... 1 MHz)	HF-Leistungsüber- trager und Drosseln High-frequency power transformers and chokes	RMLP, EFD, EV, ER, ELP, Ring / Toroids

1) @ $f = 100$ kHz, $\dot{B} = 200$ mT, $T = 100^\circ\text{C}$
 2) @ $\dot{H} = 1200$ A/m, $f = 10$ kHz, $T = 100^\circ\text{C}$

3) @ $f = 500$ kHz, $\dot{B} = 50$ mT, $T = 100^\circ\text{C}$
 4) cold cathod fluorescence lamp

RM Cores

RM-Kerne

RM-Kerne für optimale Platznutzung auf Leiterplatten

RM-Kerne sind ideal für

- äußerst verlustarme, hochstabile Filterspulen und andere resonanzbestimmende Induktivitäten (K1, M33, N48) sowie
- klirrarmer Breitbandübertrager bei kleiner Signalaussteuerung (N45, T38, T57, T66).
- RM-Kerne ohne Mittelloch werden auch in der Leistungselektronik verwendet. Als Werkstoffe werden hier typischerweise N87, N92 und N97 eingesetzt.



Die Größen sind in IEC 60431 festgelegt. Das Zubehör ist für automatische Verarbeitung geeignet. RM-Kerne werden satzweise geliefert.

RM cores for optimized PCB real estate

RM cores are ideal for

- extremely low-loss, highly stable filter coils and other resonance-determining inductive components (K1, M33, N48) as well as
- low-distortion broadband transformers for small signals (N45, T38, T57, T66).
- RM cores without center hole are also used in power electronics. Typical materials employed here are N87, N92 and N97.

The sizes are specified by IEC 60431. The accessories are suitable for automatic processing. RM cores are supplied in sets.

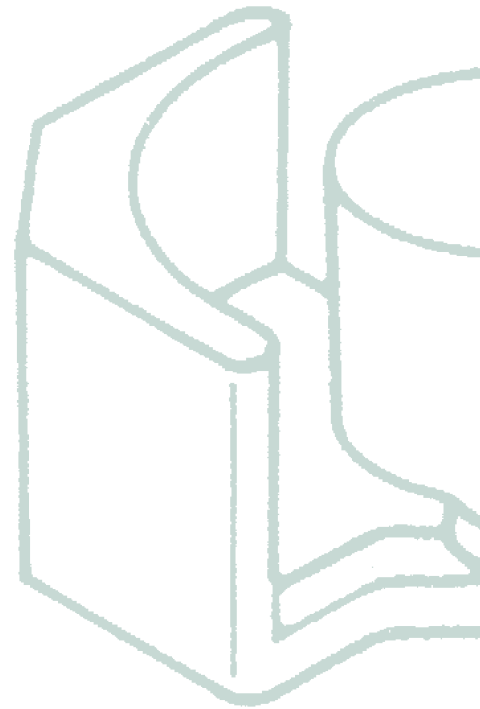

Kerne (Zubehör siehe Seite 12) / Cores (Accessories on page 12)

Typ Type	Luftspalt Air gap	Material (Kennziffer / Code number)									
		A _L -Werte (nH); A _L -Toleranzbuchstabe / A _L values (nH); A _L tolerance code									
		K1 (001)	M33 (033)	N48 (048)	N45 (045)	N30 (030)	T35 (035)	T38 (038)	T57 (057)	T66 (066)	N49 (049)
RM 4	●	16, 25 A	40, 63 A	63 A							
	●			100, 160 A							
	●				63 A						
	○				100, 160 A						
RM 5	●	25, 40 A	20, 63 A	160, 250, 315 A							
	●		100 A	1800 R	160, 250, 315 A						
	○				1800 R						
	○				1800 R	3500 R	5200 R	6700 Y	2600 R	9600 Y	1300 R
RM 6	●	40 A	63 A	200, 250, 315 A							
	●		100 A	400 A	200, 250, 315 A						
	○			2200 R	2200 R	4300 R	6200 R	8600 Y	3500 R	12300 Y	1700 R
	○				2200 R	4300 R	6200 R	8600 Y	3500 R	12300 Y	1700 R
RM 7	●			250, 315 A							
	○				3000 R						
	○					5000 R	7000 R	10000 Y			1900 R
RM 8	●			100 A							
	●			630 J							
	●			250, 315, 400 A							
	○			2900 R							
RM 10	○				2900 R	5700 R	8400 R	12500 Y	4800 R		2200 R
	○			315, 400, 630 A		7600 R	11000 R	16000 Y			2900 R
RM 12	●					8400 R	12800 R				3700 R
RM 14	○										3900 R

● = mit Luftspalt / gapped
○ = ohne Luftspalt / ungapped

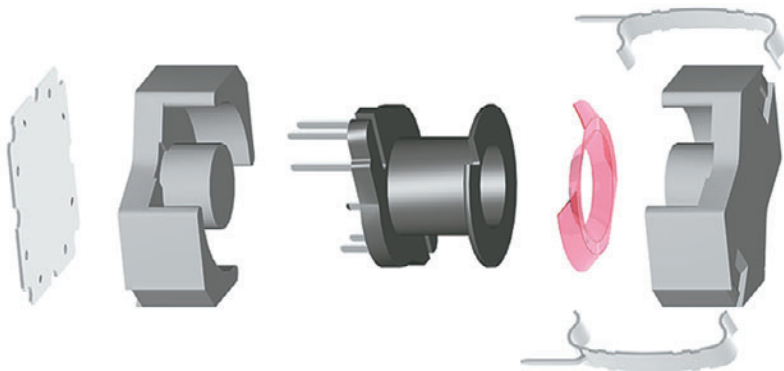

Typ Type	Magnetische Formkenngrößen (pro Satz) Magnetic characteristics (per set)				
	$\Sigma I/A$ mm ⁻¹	l_e mm	A_e mm ²	A_{min} mm ²	V_e mm ³
RM 4	1.9 (1.7)	21.0 (22.0)	11.0 (13.0)	– (11.3)	232 (286)
RM 5	1.0 (0.93)	20.8 (22.1)	20.8 (23.8)	– (18)	430 (526)
RM 6	0.86 (0.78)	26.9 (28.6)	31.3 (36.6)	– (31)	840 (1050)
RM 7	0.74 (0.70)	29.8 (30.4)	40 (43)	– (39)	1200 (1340)
RM 8	0.67 (0.59)	35.1 (38)	52 (64)	– (55)	1840 (2430)
RM 10	0.50 (0.45)	42 (44)	83 (98)	– (90)	3470 (4310)
RM 12	– (0.39)	– (57)	– (146)	– (125)	– (8340)
RM 14	– (0.35)	– (70)	– (200)	– (170)	– (14000)

Werte in Klammern für Kernsätze ohne Mittelloch / Values in parantheses for core sets without center hole

			Bestellnummer (pro Satz) Ordering code (per set)
N41 (041)	N87 (087)	N97 (097)	B65803N00**A0** B65803N0***A048 B65803J0063A045 B65803J0***A045 B65803J0000+***
	1100 R	1100 R	B65805N00**A0** B65805N0***A0** B65805J0***A045 B65805C0000R048 B65805J0000+***
2600 R	2000 R	2000 R	B65807N00**A0** B65807N0***A0** B65807J0***A0** B65807C0000R048 B65807J0000+***
3100 R	2400 R	2400 R	B65819N0***A048 B65819J0000R045 B65819J0000+***
	2700 R	2700 R	B65811F0100A048 B65811F0630J048 B65811J0***A048 B65811D0000R048 B65811J0000+***
4100 R	3300 R	3300 R	B65813N0***A048 B65813J0000+***
5500 R	4200 R	4200 R	B65815E0000+***
6000 R	5300 R	5300 R	B65887E0000+***
6800 R	6000 R	6000 R	

*, +: Siehe Bestellbeispiel
See ordering code example

Typ Type	Hauptmaße (mm) Main dimensions (mm)					
	a	$\varnothing d_1$	$\varnothing d_2$	$\varnothing d_3$	h_1	h_2
RM 4	9.8 –0.4	8.0 +0.3	3.9 –0.2	2.0 +0.1	10.5 –0.2	7.0 +0.4
RM 5	12.3 –0.5	10.2 +0.4	4.9 –0.2	2.0 +0.1	10.5 –0.2	6.3 +0.4
RM 6	14.7 –0.6	12.4 +0.5	6.4 –0.2	3.0 +0.1	12.5 –0.2	8.0 +0.4
RM 7	17.2 –0.7	14.75 +0.65	7.25 –0.3	3.0 +0.1	13.5 –0.2	8.4 +0.5
RM 8	19.7 –0.8	17.0 +0.6	8.55 –0.3	4.4 +0.2	16.5 –0.2	10.8 +0.4
RM 10	24.7 –1.1	21.2 +0.9	10.9 –0.4	5.4 +0.2	18.7 –0.2	12.4 +0.6
RM 12	29.8 –1.2	24.9 +1.1	12.8 –0.4	–	24.6 –0.2	16.8 +0.6
RM 14	34.8 –1.3	29.0 +1.0	15.0 –0.5	–	30.2 –0.2	20.8 +0.6

**Bestellbeispiel
Ordering code example**

B65803N0160A048

Bauform
Type

Ausführungsart
Version

A_L -Wert in nH für Kerne mit Luftspalt (4 Ziffern). Für Kerne ohne Luftspalt: 0000
 A_L value in nH for cores with air gap (4 digits). For cores without air gap: 0000

Kennziffern für Material
Code number for material

Kennbuchstabe für A_L -Toleranz
Code letter for A_L tolerance
A $\Delta \pm 3\%$ R $\Delta \pm 30/-20\%$
J $\Delta \pm 5\%$ Y $\Delta \pm 40/-30\%$
K $\Delta \pm 10\%$

Ausführungsarten / Versions

A, C, D mit Mittelloch (ohne Gewindehülse) with center hole (without threaded sleeve)	F, N mit Mittelloch (mit Gewindehülse) with center hole (with threaded sleeve)	E, J ohne Mittelloch without center hole
--	---	---

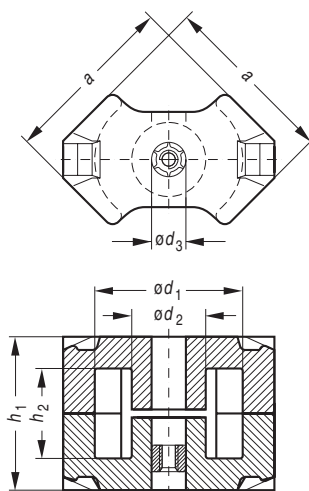

FRM0200-8

Low-Profile RM Cores

Low-Profile RM-Kerne

RM-Kerne mit deutlich verringerter Bauhöhe

Diese Kerne bieten sich an für Kleinsignal-, Schnittstellen- und Anpassungsübertrager sowie für Übertrager und Speicherdrosseln in DC/DC-Wandlern mit hoher Taktfrequenz.

Die Low-Profile-Formen eignen sich besonders für Leiterplatten, bei denen die Wicklung aufgedruckt ist und die Kerne von beiden Seiten durch die Platine gesteckt werden.

Für diese Anwendungen kommen auch die Leistungs-Materialien N49, N97 und N92 zum Einsatz.

Low-Profile-Kerne entsprechen IEC 61860.

Low-Profile RM-Kerne werden satzweise geliefert.

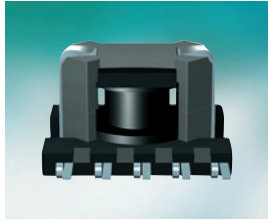

RM cores with substantially reduced total height

These cores can be used for small-signal, interface and matching transformers as well as for transformer and storage chokes in DC/DC converters with a high switching frequency. The low-profile models are especially suitable for applications in which the winding is printed on the board and the cores are inserted from both sides.

Beside the standard material N87, further power materials such as N49, N97 and N92 are usable.

Low-profile cores are in accordance with IEC 61860.

Low-profile RM cores are supplied in sets.

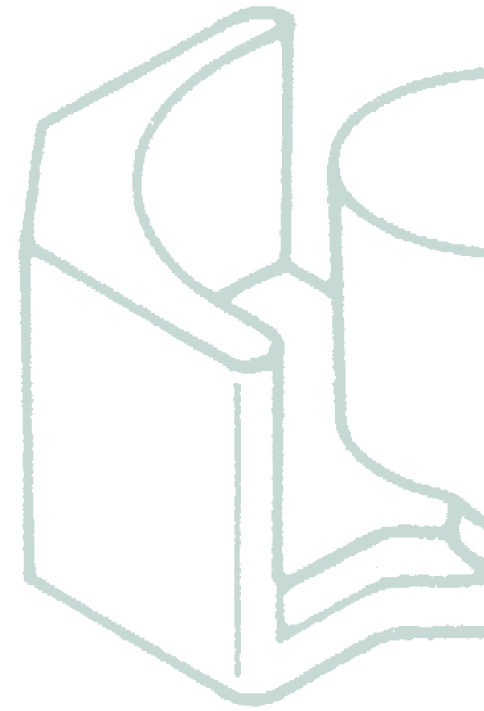

Kerne (Zubehör siehe Seite 13) / Cores (Accessories on page 13)

Typ Type	Luftspalt Air gap	Material A _L -Werte (nH) / A _L values (nH)					Bestellnummer (pro Satz) Ordering code (per set)
		T38	N49	N87	N92	N97	
RM 4 LP	○	5000 +40/-30%	950 +30/-20%	1300 +30/-20%	1300 +30/-20%	1300 +30/-20%	B65803P0000Y038
	○						B65803P0000R049
	○						B65803P0000R087
	○						B65803P0000R092
RM 5 LP	○	10500 +40/-30%	1700 +30/-20%	2400 +30/-20%	2400 +30/-20%	2400 +30/-20%	B65805P0000R049
	○						B65805P0000R087
	○						B65805P0000R092
	○						B65805P0000R097
RM 6 LP	○	11500 +40/-30%	2200 +30/-20%	3000 +30/-20%	3000 +30/-20%	3000 +30/-20%	B65807P0000Y038
	○						B65807P0000R049
	○						B65807P0000R087
	○						B65807P0000R092
RM 7 LP	○	11500 +40/-30%	2400 +30/-20%	3300 +30/-20%	3300 +30/-20%	3300 +30/-20%	B65807P0000R097
	○						B65819P0000Y038
	○						B65819P0000R049
	○						B65819P0000R087
RM 8 LP	○	2900 +30/-20%	2900 +30/-20%	4100 +30/-20%	4100 +30/-20%	4100 +30/-20%	B65819P0000R092
	○						B65819P0000R097
	○						B65811P0000R049
	○						B65811P0000R087
RM 10 LP	○	2900 +30/-20%	2900 +30/-20%	4100 +30/-20%	4100 +30/-20%	4100 +30/-20%	B65811P0000R092
	○						B65811P0000R097
	○						B65813P0000R087
	○						B65813P0000R092
RM 12 LP	○	5200 +30/-20%	5200 +30/-20%	5200 +30/-20%	5200 +30/-20%	5200 +30/-20%	B65813P0000R097
	○						B65815P0000R087
	○						B65815P0000R092
	○						B65815P0000R097
RM 14 LP	○	7100 +30/-20%	7100 +30/-20%	7100 +30/-20%	7100 +30/-20%	7100 +30/-20%	B65887P0000R087
	○						B65887P0000R092
	○						B65887P0000R087
	○						B65887P0000R097

○ = ohne Luftspalt / ungapped

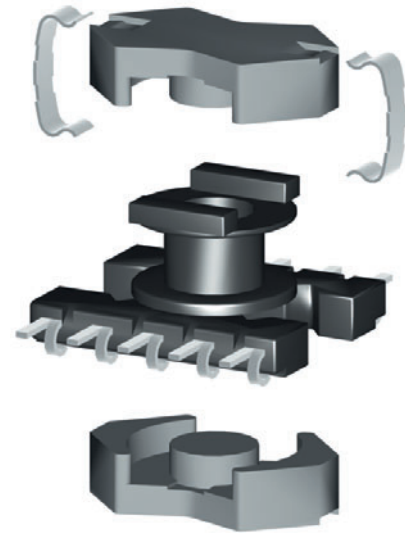

Typ Type	Magnetische Formkenngrößen (pro Satz) Magnetic characteristics (per set)				
	$\Sigma I/A$ mm ⁻¹	l_e mm	A_e mm ²	A_{min} mm ²	V_e mm ³
RM 4 LP	1.20	17.3	14.5	11.3	251
RM 5 LP	0.71	17.5	24.5	18.0	430
RM 6 LP	0.58	21.8	37.5	31.2	820
RM 7 LP	0.52	23.5	45.3	39.6	1060
RM 8 LP	0.44	28.7	64.9	55.4	1860
RM 10 LP	0.34	33.9	99.1	90.0	3360
RM 12 LP	0.28	42.0	147.5	124.7	6195
RM 14 LP	0.25	50.9	201.0	170.0	10230

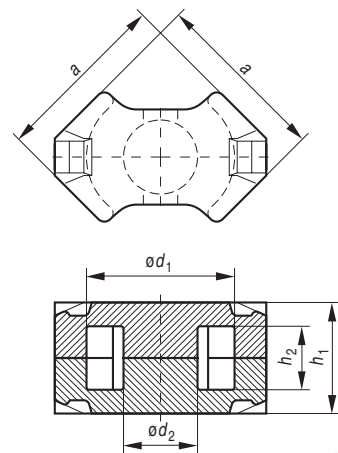

FRM0293-S

Typ Type	Hauptmaße (mm) Main dimensions (mm)				
	a	ø d ₁	ø d ₂	h ₁	h ₂
RM 4 LP	9.8 -0.4	8.0 +0.3	3.9 -0.2	7.8 -0.2	4.3 +0.4
RM 5 LP	12.3 -0.5	10.2 +0.4	4.9 -0.2	7.8 -0.2	3.6 +0.4
RM 6 LP	14.7 -0.6	12.4 +0.5	6.4 -0.2	9.0 -0.2	4.5 +0.4
RM 7 LP	17.2 -0.7	14.75 +0.65	7.25 -0.3	9.8 -0.2	4.7 +0.5
RM 8 LP	19.7 -0.8	17.0 +0.6	8.55 -0.3	11.6 -0.2	5.9 +0.4
RM 10 LP	24.7 -1.1	21.2 +0.9	10.9 -0.4	13.0 -0.2	6.7 +0.4
RM 12 LP	29.8 -1.2	24.9 +1.1	12.8 -0.4	16.8 -0.2	9.0 +0.5
RM 14 LP	34.8 -1.3	29.0 +1.0	15.0 -0.5	20.5 -0.2	11.1 +0.6

Accessories for RM Cores Zubehör für RM-Kerne

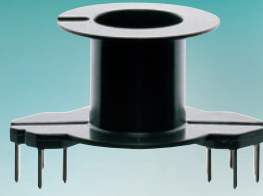
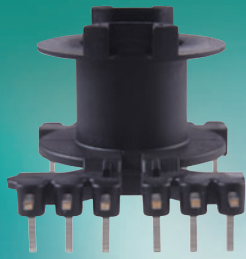

Typ Type	Spulenkörper Coil formers				Klammern ³⁾ Clamps ³⁾	Isolierscheibe 1 Insulating washer 1	Isolierscheibe 2 Insulating washer 2
	Kammern Sections	Stifte Pins	Bestellnummer ¹⁾ Ordering code ¹⁾	Merkmale ²⁾ Features ²⁾			
RM 4	1	5, 6	B65804K100*D001	Stifte / PTH	B65806A2203	B65804A5000	B65804C2005
RM 5	1	4, 5, 6, 8	B65806K100*D001	Stifte / PTH	B65806A2203	B65806A5000	B65806D2005
	2	6	B65806K1006D002	Stifte / PTH			
	1	8	B65822F1008T001	Gullwing terminals	B65806J2204		
	2	8	B65822F1008T002	Gullwing terminals			
	1	8	B65822J1008T001	J terminals			
RM 6	1	4, 5, 6	B65808N100*D001	Stifte / PTH	B65808A2203	B65808A5000	B65808C2005
	2	4, 6	B65808N100*D002	Stifte / PTH			
	1	4, 5, 6	B65808K100*D001	Stifte / PTH			
	1	8	B65808E1508T001	Leistungsanwendg. Power application			
	1	8	B65808W1508T001	Power application			
	2	8	B65808X1108D002	SNT-Übertrager SMPS transformer			
	1	8	B65821C1008T001	Gullwing terminals	B65808J2204	B65808A5000	B65808C2005
RM 7	1	8	B65820W1008D001	Stifte / PTH	B65820B2001	B65820A5000	B65820C2005
	2	8	B65820W1008D002	Stifte / PTH			
RM 8	1	5, 8, 12	B65812N10**D001	Stifte / PTH	B65812A2203	B65812A5000	B65812C2005
	2	5	B65812N1005D002	Stifte / PTH			
	1	5, 8, 12	B65812K10**D001	Stifte / PTH			
	2	8	B65812K1008D002	Stifte / PTH			
	1	12	B65812C1512T001	Leistungsanwendg. Power application			
RM 10	2	8	B65812X1108D002	SNT-Übertrager SMPS transformer			
	1	8, 12	B65814N10**D001	Stifte / PTH	B65814A2203	B65814B5000	B65814B2005
	2	8	B65814N1008D002	Stifte / PTH			
RM 12	1	12	B65814C1512T001	Leistungsanwendg. Power application			
	1	11, 12	B65816N10**D001	Stifte / PTH	B65816A2002		
RM 14	1	12	B65816C1512T001	Leistungsanwendg. Power application			
	1	10, 12	B65888N10**D001	Stifte / PTH	B65888A2002	B65888B5000	B65888B2005
	1	12	B65888C1512T001	Leistungsanwendg. Power application			

Isolierscheibe 1 = zwischen Kern und Spulenkörper
Isolierscheibe 2 = für doppelt kaschierte Leiterplatten

Insulating washer 1 = between core and coil former
Insulating washer 2 = for double-clad PCBs

Abgleichschrauben auf Anfrage.
Adjusting screws upon request.

1) * Anzahl der Stifte
* Number of pins

2) Stiftvarianten (PTH) auf Anfrage.
Pin versions (PTH) on request.

3) Bestellnummer pro Stück, 2 Stück erforderlich.
Ordering code per piece, 2 pieces required.

Accessories for Low-Profile RM Cores Zubehör für Low-Profile RM-Kerne



Typ Type	Spulenkörper Coil formers				Klammern ¹⁾ Clamps ¹⁾
	Kammern Sections	Stifte Pins	Bestellnummer Ordering code	Merkmale Features	
RM 4 LP	 1	10	B65804B6010T001	J terminals	B65804P2204

1) Bestellnummer pro Stück, 2 Stück erforderlich.
Ordering code per piece, 2 pieces required.

P Cores P 3.3 ... P 22

P-Kerne P 3.3 ... P 22

Magnetisch geschlossene Schalenkernform, sehr streufeldarm

Diese Kerne eignen sich für

- Schwingkreisspulen (Filter) mit großer Induktivitätskonstanz und hoher Güte,
- klirrarmer breitbandige Kleinsignalübertrager in den Werkstoffen T38 und N30.
- Für Leistungsanwendungen eignen sich P-Kerne ohne Mittelloch aus dem Werkstoff N87.

Aufgrund des größeren effektiven magnetischen Querschnitts zeichnen sie sich durch einen höheren A_L -Wert, eine bessere Flussdichtenverteilung und damit eine geringere Verlustleistung aus.

P-Kerne entsprechen IEC 60133. Sie werden satzweise geliefert.

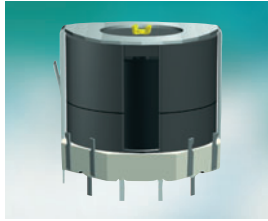

Magnetically closed pot cores, very low leakage

These cores are suitable for

- resonant-circuit coils (filters) with high inductance stability and Q,
- low-distortion broadband small-signal transformers in materials T38 and N30.
- P cores without center hole of N87 material are suitable for power applications. The larger, effective magnetic cross-section means that they feature higher A_L , better flux density distribution and thus lower power loss.

P cores are in accordance with IEC 60133. They are supplied in sets.



Kerne (Zubehör siehe Seite 17) / Cores (Accessories on page 17)

Typ Type	Luftspalt Air gap	Material (Kennziffer / Code number) A_L -Werte (nH); A_L -Toleranzbuchstabe / A_L values (nH); A_L tolerance code									
		K1 (001)	M33 (033)	N48 (048)	N30 (030)	T38 (038)					
P 3.3 x 2.6	○	25	Y			500	Y				
P 4.6 x 4.1	○			200	Y		800	Y			
P 5.8 x 3.3	○			350	R	800	Y				
P 7 x 4	●	25	A	63	A						
	●				100	A					
	○				1000	Y	2000	Y			
P 9 x 5	●	25, 40	A	63	A						
	●				100, 160, 250	A					
	○				1300	R	2500	R			
	○							5500	Y		
P 11 x 7	●	25, 40	A	40, 63	A						
	●				100, 160, 250	A					
	○			780	R	1800	R				
	○						3500	R	7000	Y	
P 14 x 8	●			100	A						
	●				160	G					
	●				250, 315, 400	A					
	○	140	R	970	R	2300	R				
	○						4600	R	9800	Y	
P 18 x 11	●	40	A	100	A	160	G				
	●					315, 400, 500	A				
	●					250	A				
	●					630	K				
	○					2900	R				
	○							5900	R	12600	Y
P 22 x 13	●					400, 630	A				
	●					250	A				
	●					1250	K				
	○	220	R			3800	R				
	○							8300	R	16000	Y

● = mit Luftspalt / gapped
○ = ohne Luftspalt / ungapped

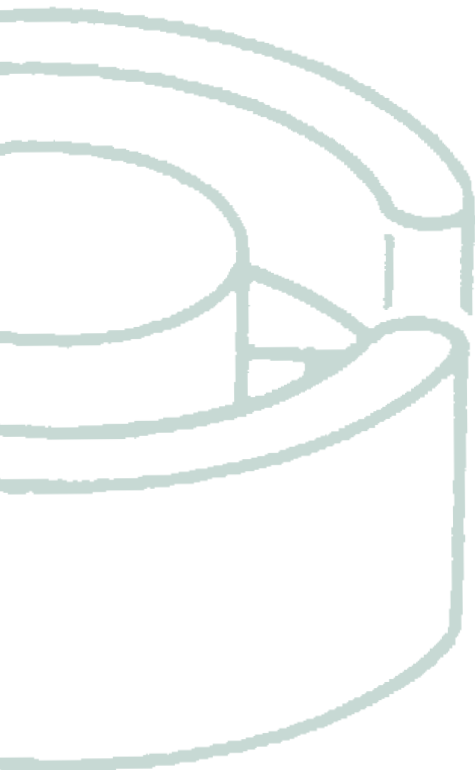

Typ Type	Magnetische Formkenngrößen (pro Satz) Magnetic characteristics (per set)				
	$\Sigma I/A$ mm ⁻¹	I_e mm	A_e mm ²	A_{min} mm ²	V_e mm ³
P 3.3 x 2.6	– (3.72)	– (5.1)	– (1.37)	–	– (7.0)
P 4.6 x 4.1	2.60	7.6	2.8	–	21.3
P 5.8 x 3.3	1.68	7.9	4.7	–	37
P 7 x 4	1.43	10.0	7.0	–	70
P 9 x 5	1.25 (1.13)	12.2 (13.4)	9.8 (11.9)	– (9.3)	120 (159)
P 11 x 7	1.00 (0.92)	15.9 (16.3)	15.9 (17.7)	– (14.9)	252 (289)
P 14 x 8	0.80 (0.73)	20.0 (21.0)	25.0 (28.7)	20.0 (23.6)	500 (603)
P 18 x 11	0.60 (0.57)	25.9 (26.6)	43.0 (46.7)	– (33.9)	1120 (1240)
P 22 x 13	0.50 (0.46)	31.6 (33.2)	63.0 (72.6)	– (58.1)	2000 (2410)

Werte in Klammern für Kernsätze ohne Mittelloch / Values in parantheses for core sets without center hole

		Bestellnummer (pro Satz) Ordering code (per set)
N87 (087)		B65491C0000Y*** B65495B0000Y033 B65495B0000Y830 B65501D0000+0** B65511A00**A0** B65511A0100A048 B65511A0000Y*** B65517D00**A0** B65517D0***A048 B65517D0000R*** B65517W0000Y038 B65531D00**A0** B65531D0***A048 B65531D0000R0**
2000	R	B65531W0000+*** B65541T0100A033 B65541T0160G048 B65541T0***A0** B65541D0000R*** B65541W0000+*** B65651T0***+0** B65651T0***A048 B65651D0250A048 B65651D0630K048 B65651D0000R048 B65651W0000+***
3600	R	B65661N0***A048 B65661D0250A048 B65661D1250K048 B65661D0000R0** B65661W0000+***
4400	R	

Typ Type	Hauptmaße (mm) Main dimensions (mm)					
	d_1	d_2	$\varnothing d_3$	$\varnothing d_4$	h_1	h_2
P 3.3 x 2.6	3.35 -0.17	2.45 +0.15	1.2 -0.1	–	2.6 -0.1	1.7 +0.2
P 4.6 x 4.1	4.65 -0.19	3.7 +0.15	2.2 -0.1	1.4 +0.05	4.1 -0.1	2.7 +0.2
P 5.8 x 3.3	5.80 -0.25	4.5 +0.2	2.5 -0.15	0.95 +0.1	3.4 -0.3	2.2 +0.2
P 7 x 4	7.35 -0.25	5.8 +0.2	3.0 -0.1	1.4 +0.05	4.2 -0.1	2.8 +0.2
P 9 x 5	9.30 -0.3	7.5 +0.25	3.9 -0.2	2.0 +0.1	5.4 -0.2	3.6 +0.3
P 11 x 7	11.3 -0.4	9.0 +0.4	4.7 -0.2	2.0 +0.1	6.6 -0.2	4.4 +0.3
P 14 x 8	14.3 -0.5	11.6 +0.4	6.0 -0.2	3.0 +0.1	8.5 -0.3	5.6 +0.4
P 18 x 11	18.4 -0.8	14.9 +0.5	7.6 -0.3	3.0 +0.1	10.6 -0.2	7.2 +0.4
P 22 x 13	22.0 -0.8	17.9 +0.6	9.4 -0.3	4.4 +0.2	13.6 -0.4	9.2 +0.4

Bestellbeispiel Ordering code example

B65541T0040A048

Bauform Type	Kennziffern für Material Code number for material
Ausführungsart Version	Kennbuchstabe für A _L -Toleranz Code letter for A _L tolerance
A _L -Werte in nH für Kerne mit Luftspalt (4 Ziffern). Für Kerne ohne Luftspalt: 0000	
A _L value in nH for cores with air gap (4 digits). For cores without air gap: 0000	
Ausführungsarten / Versions	
A, B, D mit Mittelloch (ohne Gewindehülse)	N, T mit Mittelloch (mit Gewindehülse)
with center hole (without threaded sleeve)	with center hole (with threaded sleeve)
C, W ohne Mittelloch without center hole	

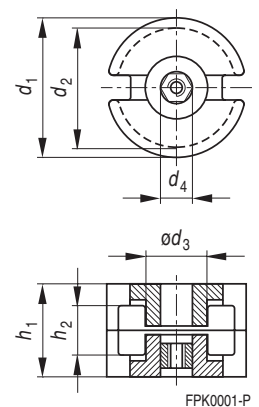

*, +: Siehe Bestellbeispiel
See ordering code example

P Cores P 26 ... P 41

P-Kerne P 26 ... P 41

Typ Type	Magnetische Formkenngrößen (pro Satz) Magnetic characteristics (per set)				
	$\Sigma I/A$ mm ⁻¹	l_e mm	A_e mm ²	A_{min} mm ²	V_e mm ³
P 26 x 16	0.40 (0.37)	37.2 (40.0)	93 (108)	76.5 (87)	3460 (4320)
P 30 x 19	0.33 (0.32)	45.0 (46.0)	136 (145)	– (117)	6100 (6670)
P 36 x 22	0.26 (0.25)	52.0 (53.5)	202 (213)	– (173)	10600 (11400)
P 41 x 25	0.257	62.1	242	200	15000

Werte in Klammern für Kernsätze ohne Mittelloch / Values in parantheses for core sets without center hole

Typ Type	Hauptmaße (mm) Main dimensions (mm)					
	d_1	d_2	$\varnothing d_3$	d_4	h_1	h_2
P 26 x 16	26.0 –1.0	21.2 +0.8	11.5 –0.4	5.4 +0.2	16.3 –0.4	11.0 +0.4
P 30 x 19	30.5 –1.0	25.0 +0.8	13.5 –0.4	5.4 +0.2	19.0 –0.4	13.0 +0.4
P 36 x 22	36.0 –1.0	29.9 +0.8	16.2 –0.4	5.4 +0.3	22.0 –0.6	14.6 +0.4
P 41 x 25	41.0 –1.1	34.0 +0.9	17.5 –0.5	5.5 +0.2	25.0 –0.6	17.0 +0.6

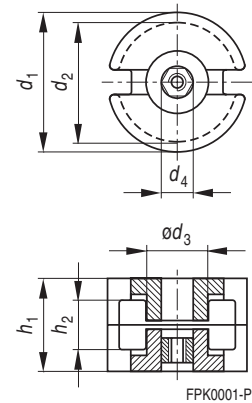

Kerne (Zubehör siehe Seite 17) / Cores (Accessories on page 17)

Typ Type	Luftspalt Air gap	Material (Kennziffer / Code number) A _L -Werte (nH); A _L -Toleranzbuchstabe / A _L values (nH); A _L tolerance code					Bestellnummer (pro Satz) Ordering code (per set)				
		M33 (033)	N48 (048)	N30 (030)	T38 (038)	N87 (087)					
P 26 x 16	●		160, 250, 315	G			B65671T0***G048				
	●	100, 160	400	A			B65671T0***A0**				
	●		630	A			B65671D0630A048				
	●		1000	J			B65671D1000J048				
	○		4900	R			B65671D0000R048				
	○				9700	R	22000	Y	5500	R	B65671W0000+***
P 30 x 19	●		400, 630	A			B65701T0***A048				
	●		1000	A			B65701T1000A048				
	○		6200	R			B65701D0000R048				
	○				11500	R	28000	Y			B65701W0000+***
P 36 x 22	●		250	G			B65611T0250G048				
	●		630	A			B65611T0630A048				
	○		7600	R			B65611D0000R048				
	○				15200	R		8000	R	B65611W0000R0**	
P 41 x 25	●		250, 630	A			B65621J0***A048				
	●		1250	A			B65621J1250A048				
	○		8400	R			B65621J0000R048				

● = mit Luftspalt / gapped
○ = ohne Luftspalt / ungapped

*, +: Siehe Bestellbeispiel
See ordering code example

Bestellbeispiel Ordering code example

B65701T0400A048

<p>Bauform Type</p> <p>Ausführungsart Version</p> <p>A_L-Werte in nH für Kerne mit Luftspalt (4 Ziffern). Für Kerne ohne Luftspalt: 0000</p> <p>A_L value in nH for cores with air gap (4 digits). For cores without air gap: 0000</p>	<p>Kennziffern für Material Code number for material</p> <p>Kennbuchstabe für A_L-Toleranz Code letter for A_L tolerance</p> <p>A $\Delta \pm 3\%$ R $\Delta + 30/-20\%$ G $\Delta \pm 2\%$ Y $\Delta + 40/-30\%$ J $\Delta \pm 5\%$</p>	<p style="text-align: center;">Ausführungsarten / Versions</p> <table style="width: 100%; border-collapse: collapse;"> <tr> <td style="width: 33%; vertical-align: top; padding: 5px;"> <p>D, J mit Mittelloch (ohne Gewindehülse) with center hole (without threaded sleeve)</p> </td> <td style="width: 33%; vertical-align: top; padding: 5px;"> <p>T mit Mittelloch (mit Gewindehülse) with center hole (with threaded sleeve)</p> </td> <td style="width: 33%; vertical-align: top; padding: 5px;"> <p>W ohne Mittelloch without center hole</p> </td> </tr> </table>	<p>D, J mit Mittelloch (ohne Gewindehülse) with center hole (without threaded sleeve)</p>	<p>T mit Mittelloch (mit Gewindehülse) with center hole (with threaded sleeve)</p>	<p>W ohne Mittelloch without center hole</p>
<p>D, J mit Mittelloch (ohne Gewindehülse) with center hole (without threaded sleeve)</p>	<p>T mit Mittelloch (mit Gewindehülse) with center hole (with threaded sleeve)</p>	<p>W ohne Mittelloch without center hole</p>			

Accessories for P Cores P 4.6 ... P 36

Zubehör für P-Kerne P 4.6 ... P 36



Typ Type	Spulenkörper Coil formers			Halterung Mounting assemblies			Isolierscheibe Insulating washer
	Kammern Sections	Stifte Pins	Bestellnummer Ordering code	Stifte Pins	Bestellnummer Ordering code	Merkmale Features	
P 7 x 4	1	–	B65512C0000T001	5	B65512C2001	Steckmontage PTH	
P 9 x 5	1	–	B65522B0000T001	4	B65518D2001	Steckmontage PTH	B65522A5000
				6	B65518D2002	Steckmontage PTH	
	SMD 1	4	B65524C1004T001			Gullwing terminals	B65522A5000
P 11 x 7	SMD 1	8	B65524C1008T001				
		1	–	B65532B0000T001	4 8	B65535B0002 B65535B0003	
P 14 x 8	1	–	B65542B0000T001	4	B65545B0009		B65542A5000
	2	–	B65542B0000T002	6	B65545B0010		
P 18 x 11	1	–	B65652B0000T001	4	B65655B0009		B65652A5000
				8	B65655B0010		
P 22 x 13	1	–	B65662B0000T001				B65662A5000
P 26 x 16	1	–	B65672B0000T001	8	B65675B0005		B65672B5000
P 30 x 19	1	–	B65702B0000T001	8	B65705B0003		B65702A5000
P 36 x 22	1	–	B65612B0000T001	10	B65615B0001		B65612A5000

Isolierscheibe = zwischen Kern und Spulenkörper
Insulating washer = between core and coil former

Abgleichschrauben auf Anfrage.
Adjusting screws upon request.

TT/PR Cores

TT/PR-Kerne

Für maximalen magnetischen Querschnitt

■ TT-Kerne sind aufgrund der runden Schalenkernform sehr streufeldarm. Durch die großen Schlitz in der anderen Kernhälfte lassen sich mehr parallele Anschlüsse herausführen.

■ PR-Kerne setzen sich aus zwei gleichen Kernhälften zusammen. Mit ihnen lassen sich als Alternative zu TT-Kernen schmalere Bauformen realisieren.

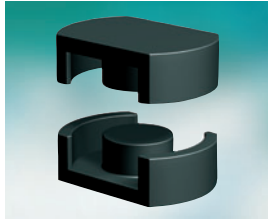

For maximum magnetic cross-section

■ TT cores feature a very low leakage field because of the round-slab core shape. The round-slab core shape offers excellent shielding as well as enough space to bring out a higher number of parallel pin connections.

■ The PR core shape consists of two equal core halves having an evident advantage: PR cores offer as an alternative to TT cores the possibility of implementing a narrower component.

Applications

Telecommunications, primarily transformers for impedance matching with low distortion. Power applications calling for low profile and a compact winding.

Anwendungen

Nachrichtentechnik, vorwiegend Übertrager zur Impedanzanpassung mit niedrigem Klirrfaktor. Leistungsanwendungen, bei denen niedrige Bauhöhe und kompakte Wicklung gefordert sind.

TT- und PR-Kerne werden satzweise geliefert.

TT and PR cores are supplied in sets.

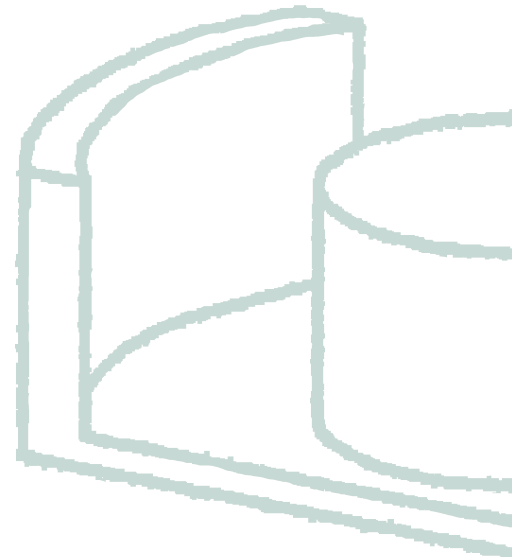

Kerne / Cores

Typ Type	Luftspalt Air gap	Material (Kennziffer / Code number) A _L -Werte (nH) / A _L values (nH)				Bestellnummer (pro Satz) ¹⁾ Ordering code (per set) ¹⁾	
		N30 (030)	T65 (065)	N87 (087)	T38 (038)	TT-Kerne TT cores	PR-Kerne PR cores
TT 14 x 8	○	4000	5200	2000		B65754J0000R***	B65755J0000R***
PR 14 x 8	○				8500	B65754J0000Y038	B65755J0000Y038
TT 18 x 11	○	5000	7200	2800		B65756J0000R***	B65757J0000R***
PR 18 x 11	○				10800	B65756J0000Y038	B65757J0000Y038
TT 23 x 11	○	7900	11800	4800		B65716L0000R***	B65738L0000R***
PR 23 x 11	○				16400	B65716L0000Y038	B65738L0000Y038
TT 23 x 18	○	6500	9200	3800		B65716J0000R***	B65738J0000R***
PR 23 x 18	○				13800	B65716J0000Y038	B65738J0000Y038
TT 30 x 19	○	9400	14000	5400		B65730J0000R***	B65735J0000R***
PR 30 x 19	○				22800	B65730J0000Y038	B65735J0000Y038
A _L -Toleranz A _L tolerance		+30/-20% ≙ R			+40/-30% ≙ Y		

○ = ohne Luftspalt / ungapped

1) ***Kennziffer für Werkstoff
***Code number for material

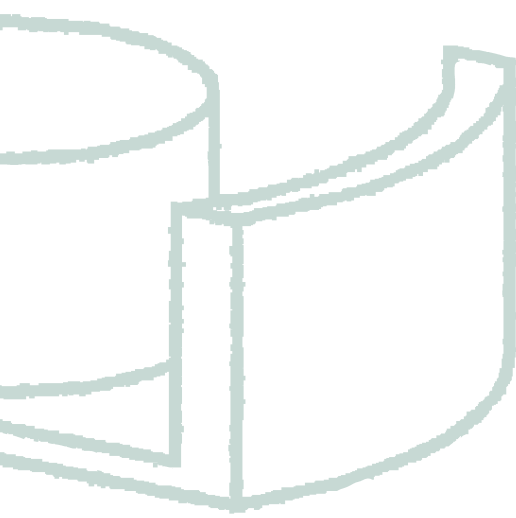

Beispiel: TT 30 x 19
Example: TT 30 x 19

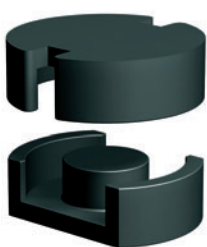

PR 23 x 11
PR 23 x 11

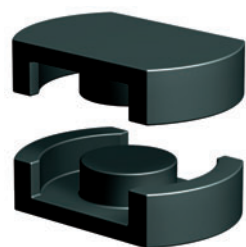

Typ Type	Magnetische Formkenngrößen (pro Satz) Magnetic characteristics (per set)				
	$\Sigma I/A$ mm ⁻¹	l_e mm	A_e mm ²	A_{min} mm ²	V_e mm ³
TT 14 x 8 PR 14 x 8	0.84	21.3	25.3	22.1	539
TT 18 x 11 PR 18 x 11	0.68	27.3	40.3	36.0	1100
TT 23 x 11 PR 23 x 11	0.45	31.2	68.8	53.4	2144
TT 23 x 18 PR 23 x 18	0.62	45.1	73.1	67.4	3293
TT 30 x 19 PR 30 x 19	0.39	46.4	119	99.4	5534

Typ Type	Hauptmaße (mm) Main dimensions (mm)					
	b	d_1 ($\varnothing d_1$)	d_2 ($\varnothing d_2$)	$\varnothing d_3$	h_1	h_2
TT 14 x 8 PR 14 x 8	9.2 -0.5 9.4 ±0.15	14.3 -0.5	11.6 +0.4	6.0 -0.2	8.5 -0.3	5.6 +0.4
TT 18 x 11 PR 18 x 11	11.8 -0.5 12.1 -0.5	18.4 -0.8	14.9 +0.4	7.6 -0.3	10.6 -0.2	7.2 +0.4
TT 23 x 11 PR 23 x 11	15.5 -0.5	23.3 -0.9	18.0 +0.6	9.9 -0.4	11.2 -0.2	7.4 +0.4
TT 23 x 18 PR 23 x 18	15.5 -0.5	23.3 -0.9	18.0 +0.6	9.9 -0.4	18.4 -0.2	14.0 +0.6
TT 30 x 19 PR 30 x 19	20.2 ±0.3	30.5 -1	25.0 +0.8	13.5 -0.4	19.0 -0.4	13.0 +0.4

PR-Kerne
PR cores

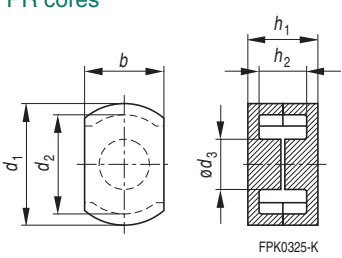

TT 14 x 8 / TT 18 x 11 / TT 30 x 19

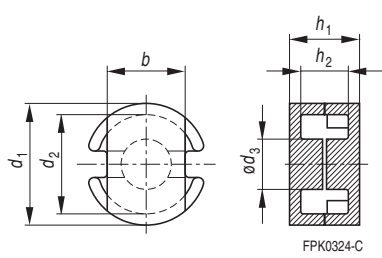

TT 23 x 11 / TT 23 x 18

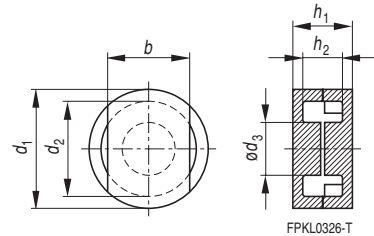

EP Cores

EP-Kerne

Für kompakte Übertrager

EP-Kerne empfehlen sich wegen ihrer kubischen Geometrie für Raum sparenden Aufbau auf der Leiterplatte.

In Verbindung mit unseren Ferrit-Werkstoffen liefert diese Bauform ausgezeichnete Eigenschaften für breitbandige, streufeldarme Kleinsignalübertragung. EP-Kerne eignen sich daher hervorragend für xDSL-Anwendungen. Bevorzugte Werkstoffe sind je nach Einsatzbedingungen T38, T66, N45 und T57.

EP-Kerne werden satzweise geliefert.

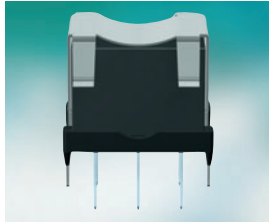

For compact transformer

With their cubic geometry, EP cores are recommended for space-saving onboard solutions.

In conjunction with our materials, these models feature excellent characteristics for broadband, small-signal transformation with low leakage field. EP core are consequently ideal for xDSL applications. Preferred materials, depending on conditions of use, are T38, T66, N45 and T57.

EP cores are supplied in sets.

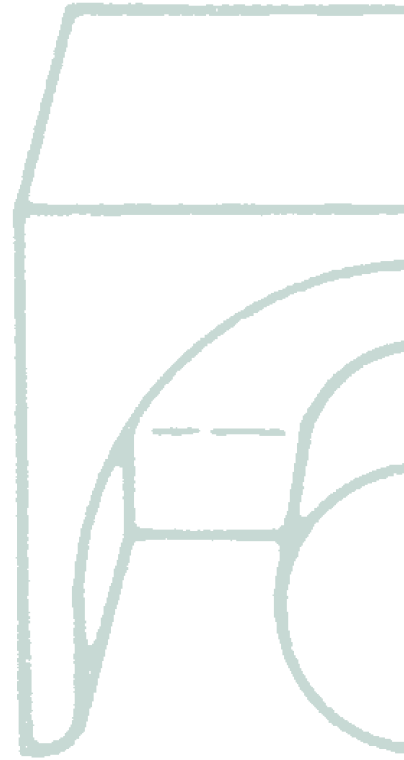

Kerne / Cores									Zubehör /		
Typ Type	Luftspalt Air gap	Material (Kennziffer / Code number)							Bestellnummer ¹⁾ (pro Satz) Ordering code ¹⁾ (per set)	Spulenkörper ²⁾ Coil formers ²⁾	
		A _L -Werte (nH); A _L -Toleranzbuchstabe / A _L values (nH); A _L tolerance code								Kammern Sections	Stifte Pins
		N45 (045)	N30 (030)	T38 (038)	T57 (057)	T65 (065)	T66 (066)	N87 (087)			
EP 5	●			16, 25 A					B65855A00**A038		
	●			40 J					B65855A0040J038		
	●			63 D					B65855A0063D038		
	○			2000 Y			2200 Y		B65855A0000Y038		
EP 7	●	63, 100 A		63, 100 A	63, 100 A		63, 100 A	63, 100 A	B65839A0***A0**	1	6
	●	160 J		160 J	160 J		160 J	160 J	B65839A0160J0**	2	6
	●	200 C		200 C	200 C		200 C	200 C	B65839A0200C0**	SMD 1	6
	●	250 E		250 E	250 E		250 E	250 E	B65839A0250E0**		
	○	1500 R	2000 R		1500 R	3000 R		1100 R	B65839A0000R***		
	○			5200 Y			5800 Y		B65839A0000Y0**		
EP 10	●	63, 100 A		63, 100 A			63, 100 A	63, 100 A	B65841A0***A0**	2	8
	●	160 J		160 J			160 J	160 J	B65841A0160J0**	1	8
	●	200 C		200 C			200 C	200 C	B65841A0200C0**		
	●	250 E		250 E			250 E	250 E	B65841A0250E0**		
	○	1600 R	2000 R		1600 R	2900 R		1100 R	B65841A0000R***		
	○			4800 Y			6000 Y		B65841A0000Y0**		
EP 13	●	63 A		63 A			63 A	63 A	B65843A0063A0**	1	10
	●	100, 160 A		100, 160 A			100, 160 A	100, 160 A	B65843A0***A0**	2	10
	●	200 B		200 B			200 B	200 B	B65843A0200B0**		
	●	250 J		250 J			250 J	250 J	B65843A0250J0**		
	●	315 C		315 C			315 C	315 C	B65843A0315C0**		
	●	400 E		400 E			400 E		B65843A0400E038		
	○	2400 R	2800 R		2500 R	4000 R		1600 R	B65843A0000R***		
	○			7000 Y			8500 Y		B65843A0000Y0**		
EP 17	○		4300 R			6200 R		2400 R	B65845J0000R***	1	8
	○			10800 Y			13000 Y		B65845J0000Y0**		
EP 20	●							200 A	B65847A0200A087	1	10
	○		6700 R			10200 R		4000 R	B65847A0000R***		
	○			18700 Y					B65847A0000Y038		

● = mit Luftspalt / gapped
○ = ohne Luftspalt / ungapped

1) *: Siehe Bestellbeispiel
See ordering code example

2) Stiftvarianten für Stiftspulenkörper auf Anfrage.
Pin versions for PTH coil formers on request.

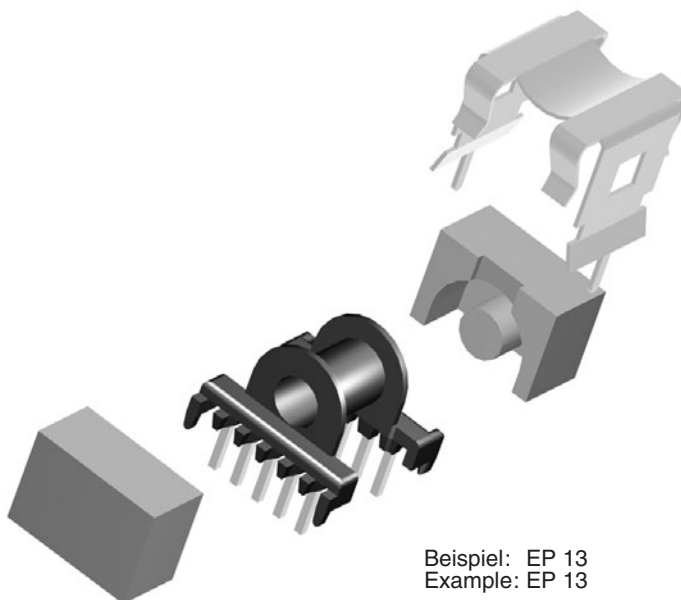

Beispiel: EP 13
Example: EP 13

Typ Type	Magnetische Formkenngrößen (pro Satz) Magnetic characteristics (per set)				
	$\Sigma I/A$ mm ⁻¹	l_e mm	A_e mm ²	A_{min} mm ²	V_e mm ³
EP 5	3.154	9.73	3.09	2.34	30
EP 7	1.52	15.7	10.3	8.5	162
EP 10	1.70	19.2	11.3	8.5	217
EP 13	1.24	24.2	19.5	14.9	472
EP 17	0.84	28.5	33.9	25.5	966
EP 20	0.51	40.0	78.0	60.0	3120

Accessories		
Bestellnummer Ordering code	Merkmale Features	Bügel ^① oder Kappe ^② Yoke ^① or cap ^②
B65840B1006D001	Stifte / PTH	B65840D2000 ^②
B65840B1006D002	Stifte / PTH	
B65840F1106T001	U terminals	
B65842C1008D002	Stifte / PTH	B65842A2000 ^①
B65842W1008D001	Stifte / PTH	
B65844W1010D001	Stifte / PTH	B65844A2000 ^①
B65844X1010D002	High-voltage	
B65846W1008D001	Stifte / PTH	B65846J2000 ^①
B65848D1010D001	Stifte / PTH	B65848A2000 ^①

Typ Type	Hauptmaße (mm) Main dimensions (mm)						
	a	h	$\varnothing d_1$	$\varnothing d_2$	l_1	l_2	
EP 5	6.15 -0.3	3.9 -0.25	4.3 +0.25	1.8 -0.15	5.7 -0.2	3.8 +0.4	
EP 7	9.4 -0.4	6.5 -0.3	7.2 +0.4	3.4 -0.2	7.5 -0.2	5.0 +0.4	
EP 10	11.8 -0.6	7.85 -0.4	9.2 +0.4	3.45 -0.3	10.4 -0.2	7.2 +0.4	
EP 13	12.8 -0.6	9.0 -0.4	9.7 +0.6	4.5 -0.3	13.0 -0.3	9.0 +0.4	
EP 17	18.4 -0.8	11.25 -0.5	11.6 +0.8	5.85 -0.35	17.0 -0.6	11.0 +0.6	
EP 20	24.5 -1.0	15.3 -0.7	16.1 +0.8	9.0 -0.5	21.6 -0.4	14.0 +0.6	

Bestellbeispiel
Ordering code example

B65839A0100A087

Bauform Type	Kennziffern für Material Code number for material
Ausführungsart Version	Kennbuchstabe für A _L -Toleranz Code letter for A _L tolerance

A_L-Werte in nH für Kerne mit Luftspalt (4 Ziffern). Für Kerne ohne Luftspalt: 0000
A_L value in nH for cores with air gap (4 digits). For cores without air gap: 0000

A Δ ± 3% D Δ ± 8%
B Δ ± 4% J Δ ± 5%
C Δ ± 6% R Δ ± 30/-20%
E Δ ± 7% Y Δ ± 40/-30%

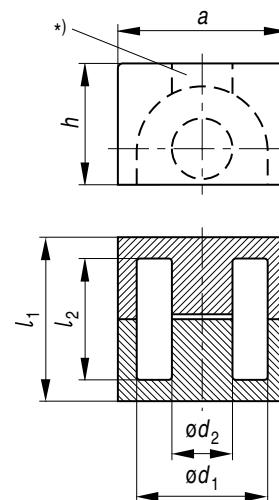

FQE0001-3

* Luftspalt (einseitig)
gapped (one-sided)

EPX/EPO Cores

EPX/EPO-Kerne

Optimierte Ferritkerne für xDSL-Anwendungen

Internet-Zugang mit DSL ist die am schnellsten wachsende Breitband-Technologie. Für entsprechende neue Anforderungen hat EPCOS Ferritkerne und -werkstoffe für DSL-Schnittstellenübertrager entwickelt. Die neuen EPX- und EPO-Kerne erhöhen bei gegebener Übertragungsrate die Reichweite der Teilnehmerleitungen bei DSL-Anwendungen.

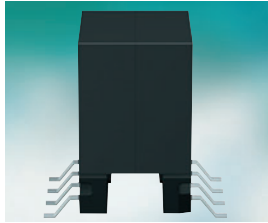

Mit diesen Neuentwicklungen gelang eine Miniaturisierung der DSL-Schnittstellenübertrager, ohne deren Leistung zu mindern. Durch die Erweiterung der Anschlüsse pro Baugruppe werden Kosteneinsparungen ermöglicht.

EPX- und EPO-Kerne werden satzweise geliefert.

Optimized ferrite cores for xDSL applications

Internet access with DSL is the fastest growing broadband technology. For the new requirements EPCOS has created ferrite cores and materials for DSL line transformers. These new EPX and EPO cores increase loop reach at a given data rate for DSL applications.

The major goal of all developments is miniaturization of the line transformer without any performance degradation. The lines per board can be increased, which enables further cost reduction.

EPX and EPO cores are supplied in sets.



Kerne / Cores							Zubehör / Accessories					
Typ Type	Luftspalt Air gap	Material (Kennziffer / Code number)				Bestellnummer (pro Satz) Ordering code (per set)	Spulenkörper Coil formers					
		A _L -Werte (nH); A _L -Toleranzbuchstabe / A _L values (nH); A _L tolerance code					Kammern Sections	Stifte Pins				
		N45 (045)	T38 (038)	T57 (057)	T66 (066)							
EPX 7/9	●		63	A	63	A	63	A	B65857A0063A0**	SMD 1	8	
	●		100	A	100	A	100	A	B65857A0100A0**			
	●		160, 200	B	160, 200	B	160, 200	B	B65857A0***B0**			
	●		250	J	250	J	250	J	B65857A0250J0**			
	●		315	C	315	C	315	C	B65857A0315C0**			
	●		400	E	400	E	400	E	B65857A0400E0**			
	○	2500	R				2600	R	B65857A0000R0**			
EPX 9/9	○	2400	R						B65857C0000R0**	SMD 1	8	
	○			8000	Y				B65857C0000Y0**			
	○						8100	Y				
EPX 10	●		63	A	63	A	63	A	B65859A0063A0**			
	●		100	A	100	A	100	A	B65859A0100A0**			
	●		160	J	160	J	160	J	B65859A0160J0**			
	●		200	C	200	C	200	C	B65859A0200C0**			
	●		250	E	250	E	250	E	B65859A0250E0**			
	○						2000	R	B65859A0000R057			
	○			6100	Y				B65859A0000Y038			
EPO 13	●		63	A	63	A	63	A	B65843P0063A0**		1	10
	●		100	A	100	A	100	A	B65843P0100A0**			
	●		160, 200	B	160, 200	B	160, 200	B	B65843P0***B0**			
	●		250	J	250	J	250	J	B65843P0250J0**			
	●		315	C	315	C	315	C	B65843P0315C0**			
	●		400	E	400	E	400	E	B65843P0400E0**			
	○						2400	R	B65843P0000R057			
○			6600	Y				B65843P0000Y038				

● = mit Luftspalt / gapped
○ = ohne Luftspalt / ungapped

* Siehe Bestellbeispiel
See ordering code example

EPX-Kerne von EPCOS sind patentiert.
EPX cores from EPCOS are patented.
DE: application no. 10056945.5
US: publication no. US-2002-0158743

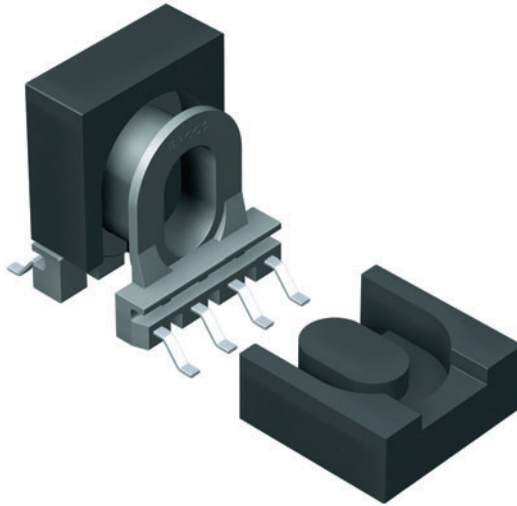

Beispiel: EPX 7/9
Example: EPX 7/9

Typ Type	Magnetische Formkenngrößen (pro Satz) Magnetic characteristics (per set)				
	$\Sigma l/A$ mm^{-1}	l_e mm	A_e mm^2	A_{\min} mm^2	V_e mm^3
EPX 7/9	0.88	15.6	17.7	13.9	276
EPX 9/9	10.9	19.0	17.5	—	333
EPX 10	1.36	21.7	15.9	13.2	345
EPO 13	1.34	25.8	19.3	14.9	498

Bestellnummer Ordering code	Merkmale Features	Kappe Cap
B65858A1008T001	Gullwing terminals	
B65852A1008D001	Gullwing terminals	
B65844W1010D001	Stifte / PTH	
B65844X1010D002	High-voltage	
B65844F1010T001	U terminals	

EPX 7/9

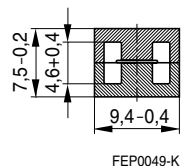
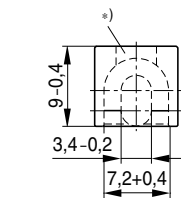

FEP0049-K

EPX 9/9

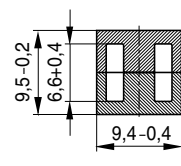
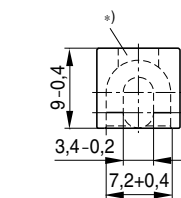

FEP0050-M

EPX 10

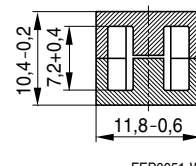
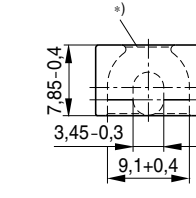

FEP0051-W

EPO 13

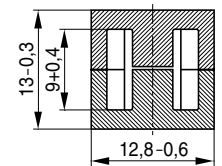
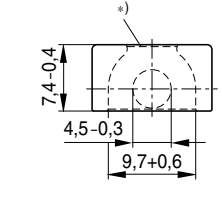

FEP0052-E

* Luftspalt (einseitig)
gapped (one-sided)

Bestellbeispiel Ordering code example

B65857A0160B066

<p>Bauform Type</p> <p>Ausführungsart Version</p> <p>A_L-Werte in nH für Kerne mit Luftspalt (4 Ziffern). Für Kerne ohne Luftspalt: 0000</p> <p>A_L value in nH for cores with air gap (4 digits). For cores without air gap: 0000</p>	<p>Kennziffern für Material Code number for material</p> <p>Kennbuchstabe für A_L-Toleranz Code letter for A_L tolerance</p> <p>A $\Delta \pm 3\%$ J $\Delta \pm 5\%$ B $\Delta \pm 4\%$ R $\Delta + 30/-20\%$ C $\Delta \pm 6\%$ Y $\Delta + 40/-30\%$ E $\Delta \pm 7\%$</p>
--	---

P Core Halves Einzelschalen

Einzelschalen für induktive Näherungsschalter

Mit induktiven Näherungsschaltern lassen sich Bewegungsabläufe und Schaltzustände berührungslos erfassen.

Hinsichtlich der Abmessungen sind Einzelschalen an die genormten Schalter angepasst. Damit können für die Schalenkerngrößen jeweils maximale Schaltabstände erreicht werden. Kerne mit der Bezeichnung „PS“ sind nach DIN 41001 genormt.

Werkstoffauswahl:

- bis 1 MHz N 22
- bis 2 MHz M 33



P core halves for inductive proximity switches

Inductive proximity switches can be used as noncontacting motion detectors and output indicators. Pot core halves are matched to

standard switches in their dimensions. Maximum operating distances can thus be achieved for individual P core sizes. Cores with the “PS” designation have been

standardized to DIN 41001.

Material choice:

- up to 1 MHz N 22
- up to 2 MHz M 33



Kerne / Cores				Zubehör / Accessories	
Typ Type	Material			Bestellnummer Ordering code	Spulenkörper Coil formers
	N22	M33	N27		
5.6 x 3.7	X			B65931C0000X022 B65931C0000X033	
PS 7.35 x 3.6	X			B65933A0000X022 B65933A0000X033	B65512C0000T001
PS 9 x 3.5	X			B65935E0000X022 B65935E0000X033	B65936A0000T001
14.4 x 7.5	X			B65937A0000X022	B65542B0000T001
PS 25 x 8.9	X			B65939A0000X022	B65940B0000T001
PS 30.5 x 10.2	X			B65941A0000X022	B65942B0000T001
PS 35 x 10.8	X			B65947A0000X022	
PS 47 x 14.9	X			B65943A0000X022	
PS 68 x 14.5	X			B65928A0000X022	B65946B0000T001
70 x 14.5	X			B65945A0000X022	B65946B0000T001
150 x 30			X	B65949A0000X027	

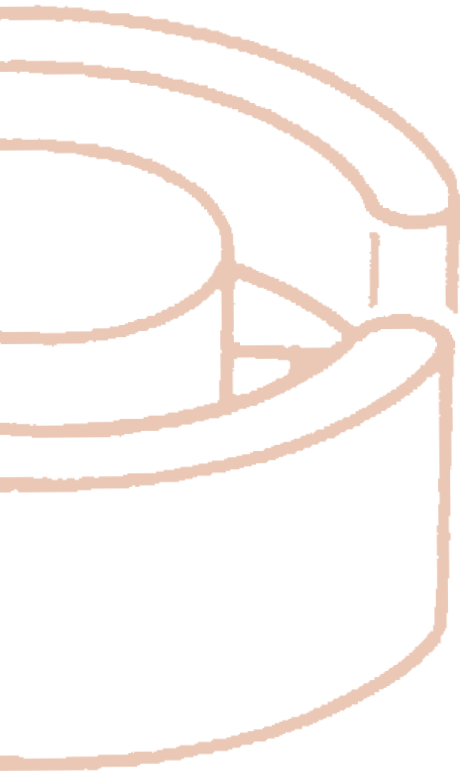

Typ Type	Hauptmaße (mm) Main dimensions (mm)					
	d ₁	d ₂	∅ d ₃	∅ d ₄	h ₁	h ₂
PS 25.9 x 8.9	24.8 -1.0	20.5 +1.0	11.3 -0.6	5.2 +0.4	8.9 -0.45	5.9 +0.4
PS 30.5 x 10.2	30.5 -1.0	25.0 +0.8	13.5 -0.4	5.4 +0.2	10.2 -0.5	7.0 +0.4
PS 35 x 10.8	35.0 -1.0	29.2 +1.2	15.7 -0.6	5.3 +0.3	10.8 -0.5	7.2 +0.4
PS 47 x 14.9	47.0 -1.3	39.0 +1.1	20.0 -0.6	5.5 +0.2	14.9 -0.7	10.0 +0.5

PS 25 x 8.9 / PS 30.5 x 10.2

PS 35 x 10.8 / PS 47 x 14.9

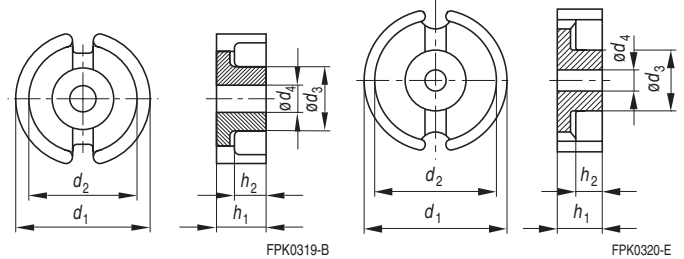

5.6 x 3.7

PS 7.35 x 3.6

PS 9 x 3.5

14.4 x 7.5

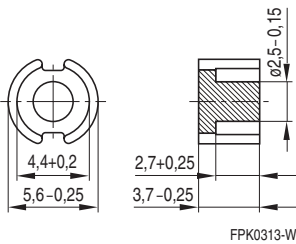

FPK0313-W

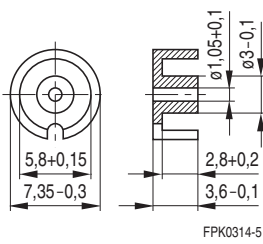

FPK0314-5

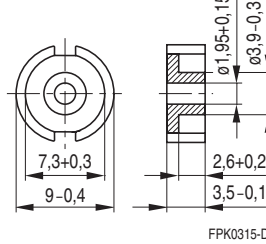

FPK0315-D

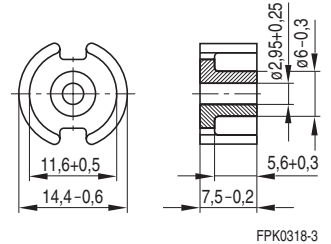

FPK0318-3

PS 68 x 14.5

70 x 14.5

150 x 30

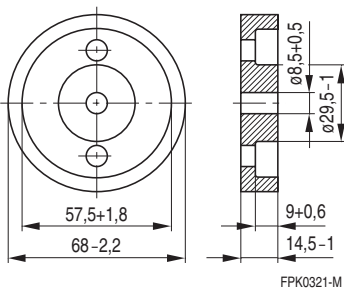

FPK0321-M

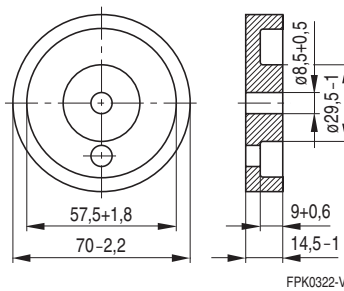

FPK0322-V

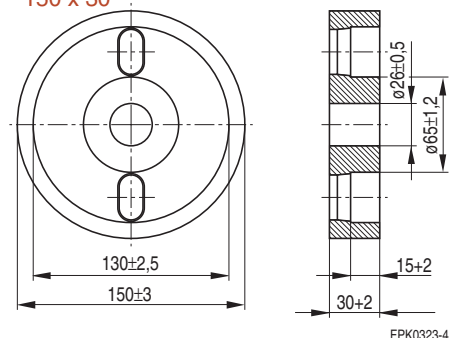

FPK0323-4

PM Cores

PM-Kerne

PM-Kerne für die Übertragung sehr hoher Leistungen

In zahlreichen Anwendungen in der Nachrichtentechnik und Industrie-elektronik hat sich diese Schalenkernform als vorteilhaft erwiesen:

- Großer Flussquerschnitt, daher günstig für hohe Leistungen bei wenig Windungszahlen,
- geringe Streuinduktivität und Eigenkapazität,
- gute Schirmung durch kompakte Form,
- die Möglichkeit, einen Luftspalt sehr genau einzuschleifen.



PM cores for handling very high powers

The benefits of this pot core have been proven in numerous applications in telecommunications and industrial electronics:

- wide flux area for high power at a minimum number of turns.
- low magnetic leakage and stray capacitance,
- good shielding owing to the closed form,
- precisely ground air gaps.

PM cores are in accordance with IEC 61247.

They are supplied in sets.

PM-Kerne entsprechen IEC 61247. Sie werden satzweise geliefert.

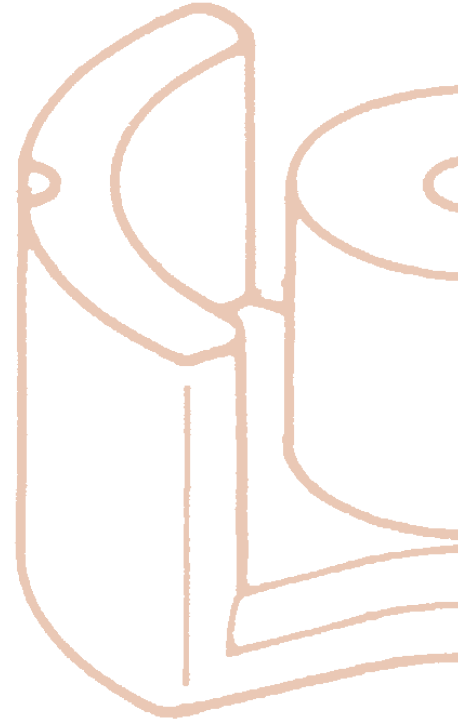

Kerne / Cores				Zubehör / Accessories			
Typ Type	Luftspalt Air gap	Material A _L -Werte (nH) / A _L values (nH)		Bestellnummer (pro Satz) Ordering code (per set)	Spulenkörper Coil formers		
		N27	N87		Kammern Sections	Lötanschlüsse Solder pins	Bestellnummer Ordering code
PM 50/39	●	250 ±3%		B65646A0250A027	1	14	B65647B1014T001
	●	630 ±3%		B65646A0630A027			
	○	7400 +30/-20%		B65646A0000R027			
	○		7400 +30/-20%	B65646A0000R087			
PM 62/49	●	315 ±3%		B65684A0315A027	1	16	B65685B1016T001
	●	630 ±3%		B65684A0630A027			
	○	9200 +30/-20%		B65684A0000R027			
	○		9200 +30/-20%	B65684A0000R087			
PM 74/59	●	315 ±3%		B65686A0315A027	1	18	B65687A1018T001
	●	630 ±3%		B65686A0630A027			
	○	10000 +30/-20%		B65686A0000R027			
	○		10000 +30/-20%	B65686A0000R087			
PM 87/70	●	400 ±3%		B65713A0400A027	1	20	B65714K1020T001
	●	5000 ±15%		B65713A5000L027			
	○	12000 +30/-20%		B65713A0000R027			
PM 114/93	●	630 ±3%		B65733A0630A027	1	-	B65734B1000T001
	●	6300 ±15%		B65733A6300L027			
	○	16000 +30/-20%		B65733A0000R027			

- = mit Luftspalt / gapped
- = ohne Luftspalt / ungapped

1) Komplette Halterung mit Muttern und Scheiben
Complete mounting assembly incl. nuts and washers

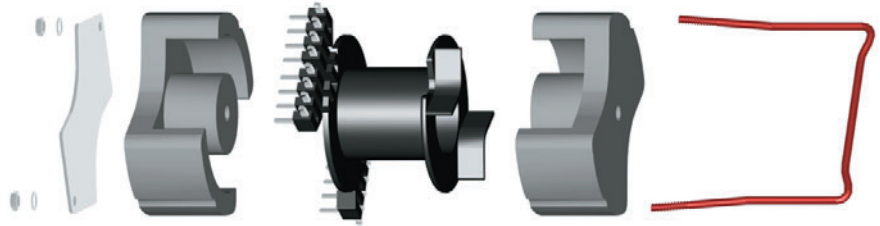

Typ Type	Magnetische Formkenngrößen (pro Satz) Magnetic characteristics (per set)				
	$\Sigma I/A$ mm^{-1}	l_e mm	A_e mm^2	A_{min} mm^2	V_e mm^3
PM 50/39	0.227	84	370	280	31000
PM 62/49	0.191	109	570	470	62000
PM 74/59	0.162	128	790	630	101000
PM 87/70	0.161	146	910	700	133000
PM 114/93	0.116	200	1720	1380	344000

Halterung ¹⁾ Mounting assemblies ¹⁾	
B65647A2000	
B65685A2000	
B65687A2000	
-	
-	

Typ Type	Hauptmaße (mm) Main dimensions (mm)					
	d_1	d_2	$\varnothing d_3$	$\varnothing d_4$	h_1	h_2
PM 50/39	50 -1.7	39.0 +1.3	20.0 -0.6	5.4 +0.2	39 -0.4	26.4 +0.8
PM 62/49	62 -2.0	48.8 +1.5	25.5 -0.8	5.4 +0.2	49 -0.4	33.4 +0.8
PM 74/59	74 -2.5	57.5 +1.8	29.5 -1.0	5.4 +0.3	59 -0.6	40.7 +0.8
PM 87/70	87 -3.0	67.1 +2.1	31.7 -1.0	8.5 +0.3	70 -0.8	48.0 +0.8
PM 114/93	114 -4.5	88.0 +3.7	43.0 -1.4	5.4 +1.4	93 -1.0	63.0 +1.6

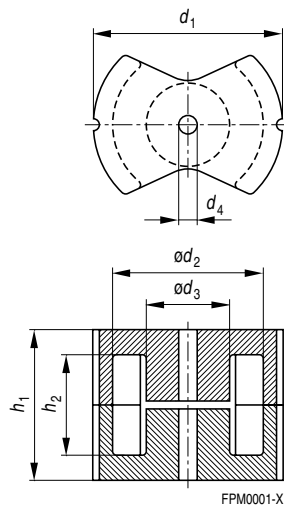

U/I Cores

U/I-Kerne

Für Leistungs-, Impuls- und Hochspannungsübertrager

■ U-Kerne mit rechteckiger Querschnittsfläche sind preisgünstige, jedoch etwas sperrige Kernformen. Für hohe übertragbare Leistungen werden sie jedoch bevorzugt verwendet, da sie durch verschiedene Kombinationsmöglichkeiten Leistungsübertragungen bis in den kW-Bereich ermöglichen.

■ I-Kerne in Kombination mit U-Kernen erlauben den Aufbau einfacher Übertrager.

U- und I-Kerne werden stückweise geliefert.

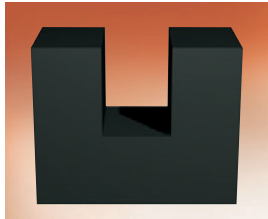

For power, pulse and high-voltage transformers

■ U cores with a rectangular cross-section are a low-cost but somewhat bulky core form. Offering various combination possibilities, they are preferred for high-power transformation and can be used into the kW region.

■ I cores combined with U cores allow the design of simple transformers.

U and I cores are supplied singly.

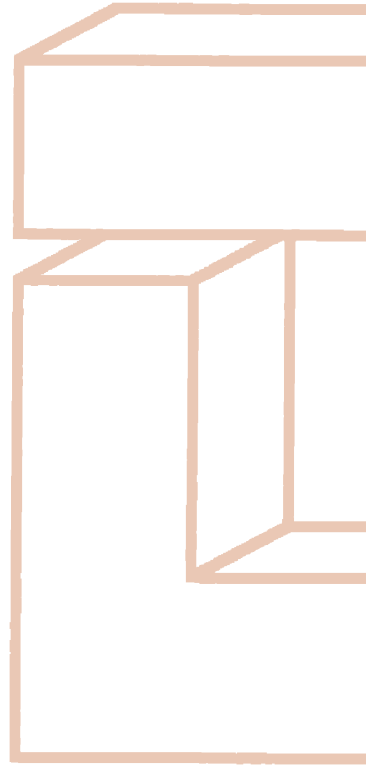

Kerne / Cores								
Typ Type	Magnetische Formkenngrößen (pro Satz) Magnetic characteristics (per set)					Material A _L -Werte (nH) / A _L values (nH)		Bestellnummer (pro Stück)
	Σl/A mm ⁻¹	l _e mm	A _e mm ²	A _{min} mm ²	V _e mm ³	N 27	N 87	Ordering code (per piece)
U 93/76/16 ¹⁾	0.79	354	448	448	159000	2900 +30/-20%		B67345B0003X027
U 93/76/20 ¹⁾	0.63	354	560	560	198000	3600 +30/-20%		B67345B0010X027
U 93/76/30 ¹⁾	0.42	354	840	840	297000	5400 +30/-20%		B67345B0001X027
							5700 +30/-20%	B67345B0001X087
U 101/76/30	0.45	368	825	825	303600	4600 +30/-20%		B67370A0002X027
U 141/78/30	0.28	377	1350	1350	508950	7500 +30/-20%		B67374G0000X127
I 93/28/16 ²⁾	0.58	258	448	448	116000	3800 +30/-20%		B67345B0004X027
I 93/28/20 ²⁾	0.46	258	560	560	144000	4900 +30/-20%		B67345B0011X027
I 93/28/30 ²⁾	0.31	258	840	840	217000	7400 +30/-20%		B67345B0002X027
							7900 +30/-20%	B67345B0002X087

- 1) Magn. Formkenngrößen und A_L-Wert gelten für einen UU-Kernsatz.
Magn. characteristics and A_L value apply to an UU core set.
- 2) Magn. Formkenngrößen und A_L-Wert gelten für einen UI-Kernsatz.
Magn. characteristics and A_L value apply to an UI core set.

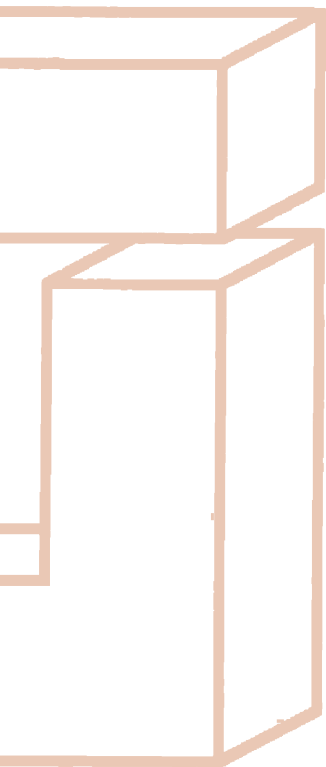

Typ Type	Hauptmaße (mm) Main dimensions (mm)				
	a	b	c	d	e
U 93/76/16	93.0 ±1.8	76.0 ±0.5	16.0 ±0.5	34.6 min.	48.0 ±0.9
I 93/28/16	93.0 ±1.8	28.0 ±0.5	16.0 ±0.5	–	–
U 93/76/20	93.0 ±1.8	76.0 ±0.5	20.0 ±0.5	34.6 min.	48.0 ±0.9
I 93/28/20	93.0 ±1.8	28.0 ±0.5	20.0 ±0.5	–	–
U 93/76/30	93.0 ±1.8	76.0 ±0.5	30.0 ±0.5	34.6 min.	48.0 ±0.9
I 93/28/30	93.0 ±1.8	28.0 ±0.5	30.0 ±0.5	–	–
U 101/76/30	101.0 ±1.8	76.0 ±0.5	30.0 ±0.6	45.0 min.	48.0 ±0.9
U 141/78/30	141.0 ±5	78.5 ±0.5	30.0 ±1	50.0 min.	33.5 ±1

U-Kerne / U cores

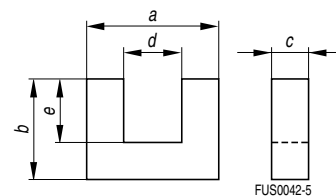

I-Kerne / I cores

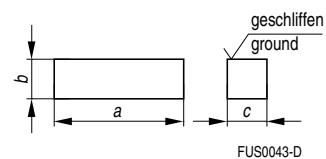

E Cores E 5 ... E 20

E-Kerne E 5 ... E 20

Klassische E-Kerne mit eckigem Mittelschenkel (E 5 bis E 80)

Für diese E-Kernform steht eine Vielzahl von Größen zur Verfügung. Die Hauptanwendungsfelder sind Leistungsübertrager und Drosseln für SNT, jedoch auch Kleinsignalanwendungen.

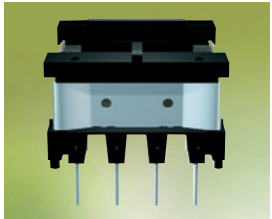

Dem Nachteil der ungünstigen Wickelform und der streufeldintensiven Geometrie steht der große Vorteil einer einfachen und wirtschaftlich günstig zu fertigen Kernform gegenüber.

E-Kerne werden stückweise geliefert.

Conventional E cores with rectangular center leg (E 5 through E 80)

These E cores are available in a wide variety of sizes. The main areas of use are power transformers and

chokes for switch-mode power supplies and also small-signal applications. The disadvantages of an unfavorable winding form and the intensive leakage field produced by the geometry are countered

by the major advantage of a simple core form that is economical to produce.

E cores are supplied in single units.

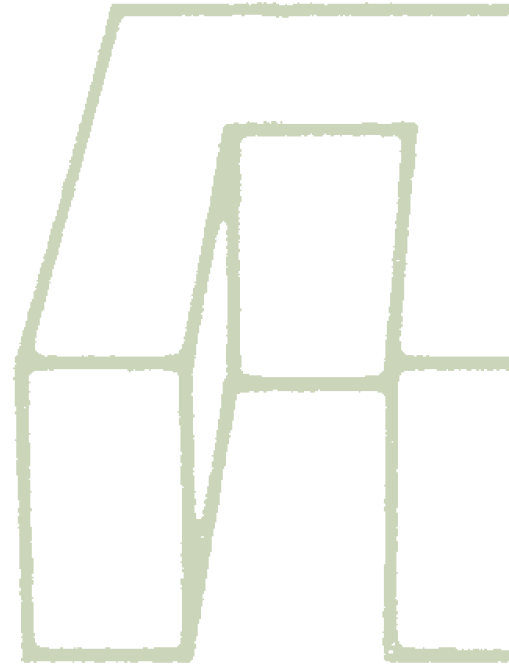

Kerne / Cores							Zubehör / Accessories				
Typ Type	Luftspalt Air gap	Material (Kennziffer / Code number)					Bestellnummer (pro Stück) Ordering code (per piece)	Spulenkörper Coil formers			
		A _L -Werte (nH) bzw. Maß g (mm) für Kerne mit Luftspalt A _L values (nH) or dim.g (mm) for cores with air gap						Kammern Sections	Stifte Pins	Bestellnummer Ordering code	
		N30 (30)	T38 (38)	N27 (27)	N87 (87)	N97 (97)					
E 5	○		1400			270	B66303G0000X1**				
E 6.3	○	700	1700			380	B66300G0000X1**	SMD 1	4	B66301B1004T001	
									1	6	B66301B1006T001
E 8.8	○	1000	2100			550	B66302G0000X1**	SMD 2	6	B66301B1006T002	
									1	8	B66302D1008T001
E 10/5.5/5	○			750 ±25%	800 ±25%		B66322G0000X1**				
E 13/7/4	○	1000		800	850		B66305G0000X1**	SMD 1	1	8	B66202A1108T001
	●			0.04			B66305G0040X127		1	6	B66202J1106T001
E 14/8/4	○	1250		860			B66219G0000X1**				
	○			1100			B66393G0000X127				
E 16/8/5	○	1400		950	1000	1050	B66307G0000X1**	SMD 1	1	8	B66308A1108T001
	●			0.06	0.06		B66307G0060X1**		1	8	B66308J1108T001
	●			0.1/0.5	0.1/0.5		B66307G0***X1**				
E 19/8/5 ¹⁾	○	1700		1050	1150		B66379G0000X1**				
E 20/10/6	○	2150		1300	1470	1500	B66311G0000X1**	SMD 2	1	10	B66206A1110T001
	●			0.09	0.09		B66311G0090X1**		1	10	B66206J1110T001
	●			0.17	0.17		B66311G0170X1**		1	12	B66206C1012T001
	●			0.25	0.25		B66311G0250X1**		1	14	B66206C1014T001
	●			0.5	0.5		B66311G0500X1**		1	6	B66206J1106T001
									2	6	B66206J1106T002
A _L -Wert-Toleranz Tol. of A _L value		+30% -20%	+40/ -30%	+30/ -20%	+30/ -20%	+30/ -20%					

● = mit Luftspalt / gapped
○ = ohne Luftspalt / ungapped

* Siehe Bestellbeispiel
See ordering code example

1) Größe entspricht U.S. lam size E cores E187.
Size corresponds to U.S. lam size E cores E187.

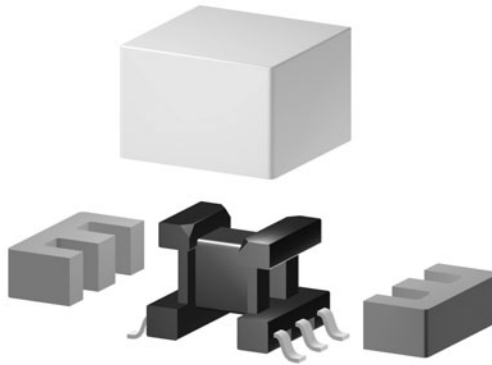

Beispiel: E 6.3 mit SMD-Spulenkörper und Kappe

Example: E 6.3 with SMD coil former and cap

Typ Type	Magnetische Formkenngrößen (pro Satz) Magnetic characteristics (per set)				
	$\Sigma l/A$ mm ⁻¹	l_e mm	A_e mm ²	A_{min} mm ²	V_e mm ³
E 5	4.86	12.6	2.6	2.5	33
E 6.3	3.70	12.2	3.3	2.6	40.3
E 8.8	3.10	15.5	5.0	3.6	78
E 13/7/4	2.39	29.6	12.4	12.2	367
E 14/8/4	2.19	33.9	15.5	13.1	525
E 16/6/5	1.49	28.6	19.2	17.6	549
E 16/8/5	1.87	37.6	20.1	19.4	756
E 19/8/5 ¹⁾	1.76	39.6	22.5	22.1	891
E 20/10/6	1.44	46.3	32.1	31.9	1490

Merkmale Features	Halterung Mounting assemblies
Gullwing terminals	B66301C2000 (Kappe / Cap)
Gullwing terminals	B66302A2000 (Kappe / Cap)
horizontal vertical	B66202A2010 (Bügel / Yoke)
Gullwing terminals	B66414A7000 (Abdeckplatte / cover plate)
horizontal vertical	B66308A2010 (Bügel / Yoke)
horizontal vertical	B66206A2010 (Bügel / Yoke)
Winkelstifte angle pins	
für Leuchtentechnik for luminaire	B66206A2001 (Bügel / Yoke)

Typ Type	Hauptmaße (mm) Main dimensions (mm)					
	a	b	c	d	e	f
E 5	5.25 ±0.1	2.65 ±0.05	2.0 -0.1	3.9 ±0.1	1.93 +0.15	1.35 ±0.05
E 6.3	6.3 -0.25	2.9 -0.1	2.0 -0.1	3.6 +0.2	1.85 +0.15	1.4 -0.1
E 8.8	9.0 ±0.25	4.1 -0.2	2.0 -0.1	5.2 +0.13	2.03 +0.25	1.9 ±0.12
E 13/7/4	12.6 +0.5/-0.4	6.5 -0.2	3.7 -0.3	8.9 +0.6	4.5 +0.3	3.7 -0.3
E 14/8/4	14.3 -0.7	7.8 -0.3	4.3 -0.3	10.5 +0.6	5.2 +0.4	4.3 -0.3
E 16/6/5	16.0 +0.7/-0.5	5.8 -0.2	4.7 -0.4	11.3 +0.6	3.6 +0.3	4.7 -0.3
E 16/8/5	16.0 +0.7/-0.5	8.2 -0.3	4.7 -0.4	11.3 +0.6	5.7 +0.4	4.7 -0.3
E 19/8/5 ¹⁾	19.0 ±0.4	8.0 ±0.13	4.8 ±0.2	14.3 ±0.3	5.7 ±0.13	4.8 ±0.2
E 20/10/6	20.4 -0.8	10.1 -0.3	5.9 -0.4	14.1 +0.6	7.0 +0.3	5.9 -0.3

Bestellbeispiel Ordering code example

B66311G0500X127

Bauform Type	Kennziffern für Material Code number for material
Kennzeichen für tolerierten Luftspalt Code letter for tolerated air gap	Füllnummer Filling number
Luftspalt „Maß g“ in tausendstel Millimeter (4 Ziffern). „0000“ bei Kernen ohne Luftspalt.	Air gap “dim. g” in thousandths of millimeter (4 digits). “0000” for cores without air gap.

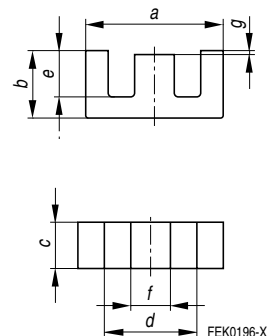

E Cores E 21 ... E 36

E-Kerne E 21 ... E 36

Für Leistungsanwendungen werden Werkstoffe mit geringen Verlustleistungen benötigt.

Geeignete Werkstoffe:

- N 27 bis ca. 100 kHz
- N 87 und N 97 bis 500 kHz

Werden zusätzlich noch hohe Sättigungseigenschaften verlangt, empfehlen wir den Werkstoff N 92, der auf Anfrage erhältlich ist.

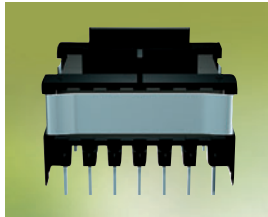

For power applications material with low power loss is needed.

We recommend:

- N 27 up to 100 kHz
- N 87 and N 97 up to 500 kHz

If high saturation characteristics are required in addition to low power loss, inquire for material N 92.



Kerne / Cores						Zubehör / Accessories			
Typ Type	Luftspalt Air gap	Material (Kennziffer / Code number)				Bestellnummer (pro Stück) Ordering code (per piece)	Spulenkörper Coil formers		
		A _L -Werte (nH) bzw. Maß g (mm) für Kerne mit Luftspalt A _L values (nH) or dim.g (mm) for cores with air gap					Kamm. Sect.	Stifte Pins	Bestellnummer Ordering code
		N30 (30)	N27 (27)	N87 (87)	N97 (97)				
E 21/9/5	○	1500	900			B66314 G0000X1**			
E 25/13/7	○	2900	1750	1850	1900	B66317 G0000X1**	1	10	B66208A1110T001
	●		0.1	0.1		B66317 G0100X1**	1	10	B66208J1110T001
	●		0.16	0.16		B66317 G0160X1**	1	10	B66208W1010T001
	●		0.25	0.25		B66317 G0250X1**	1	9	B66208K1009T001
	●		0.5	0.5		B66317 G0500X1**			
	●		1.0	1.0		B66317 G1000X1**			
E 25.4/10/7 ¹⁾	○	2700	1500	1670		B66315 G0000X1**			
	●		0.5			B66315 G0500X127			
E 30/15/7	○	3100	1700	1900	1950	B66319 G0000X1**	1	14	B66232A1114T001
	●		0.1	0.1		B66319 G0100X127	1	14	B66232B1114T001
	●		0.18	0.18		B66319 G0180X167	1	12	B66232J1112T001
	●		0.34	0.34		B66319 G0340X1**			
E 32/16/9	○	3800	2100	2300	2400	B66229 G0000X1**	1	14	B66230A1114T001
	●		0.5	0.5		B66229 G0500X1**	2	14	B66230A1114T002
	●		1.0	1.0		B66229 G1000X1**			
	●			2900	3000	B66233 G0000X1**			
E 32/16/11	○					B66370 G0000X127			
E 34/14/9 ¹⁾	○		2300			B66389 G0000X1**	1	16	B66390A1016T001
E 36/18/11	○		2900	3100	3200	B66389 G0000X1**			
	●		1.0			B66389 G1000X127			
A _L -Wert-Toleranz Tol. of A _L value		+30/-20%	+30/-20%	+30/-20%	+30/-20%				

- = mit Luftspalt / gapped
- = ohne Luftspalt / ungapped

** Kennziffer für Werkstoff
Code number for material

1) Größe entspricht U.S. lam size E cores
Size corresponds to U.S. lam size E cores
E25.4/10/7 ≙ E2425; E34/14/9 ≙ E375

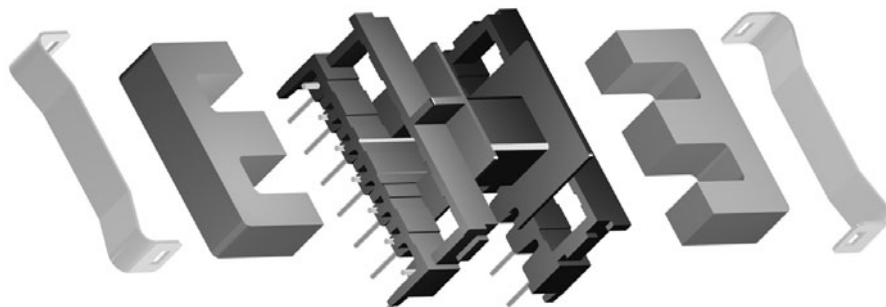

Typ Type	Magnetische Formkenngrößen (pro Satz) Magnetic characteristics (per set)				
	$\Sigma I/A$ mm ⁻¹	l_e mm	A_e mm ²	A_{min} mm ²	V_e mm ³
E 21/9/5	2.01	43.4	21.6	20.2	937
E 25/13/7	1.10	57.5	52.5	51.5	3020
E 25.4/10/7 ¹⁾	1.27	49.2	38.8	38.4	1910
E 30/15/7	1.12	67	60	49.0	4000
E 32/16/9	0.89	74	83	81.4	6140
E 32/16/11	0.76	74	97	95.0	7180
E 34/14/9 ¹⁾	0.82	69.6	84.8	83.2	5900
E 36/18/11	0.68	81	120	112	9670

	Magn. Achse Magnetic axis	Bügel Yoke
	horizontal	B66208A2010
	vertical	
	vertical	B66208A2003
	für SNT/for SMPS	
	horizontal	B66232A2010
	horizontal	
	vertical	B66230A2010
	horizontal	
	horizontal	
	horizontal	

Typ Type	Hauptmaße (mm) Main dimensions (mm)						
	a	b	c	d	e	f	
E 21/9/5	21.1 -1.0	8.7 -0.4	5.0 -0.4	16.0 +0.8	6.0 +0.4	5.0 -0.4	
E 25/13/7	25.0 +0.8/-0.7	12.8 -0.5	7.5 -0.6	17.5 +0.8	8.7 +0.5	7.5 -0.5	
E 25.4/10/7 ¹⁾	25.4 ±0.7	9.78 -0.15	6.5 -0.5	18.8 +0.8	6.48 +0.3	6.5 -0.4	
E 30/15/7	30.0 +0.8/-0.6	15.2 -0.4	7.3 -0.5	19.5 +0.8	9.7 +0.6	7.2 -0.5	
E 32/16/9	32.0 +0.9/-0.7	16.4 -0.6	9.5 -0.7	22.7 +1.0	11.2 +0.6	9.5 -0.6	
E 32/16/11	32.0 +0.7/-0.5	16.4 -0.6	11.0 -0.7	22.7 +1.0	11.2 +0.6	9.5 -0.6	
E 34/14/9 ¹⁾	34.6 ±0.7	14.65 -0.75	9.7 -0.8	25.1 +1.0	9.5 +0.5	9.65 -0.55	
E 36/18/11	36.0 +1.0/-0.7	18.0 -0.4	11.5 -0.5	24.5 +1.2	12.0 +0.6	10.2 -0.5	

**Bestellbeispiel
Ordering code example**

B66317G1000X127

Bauform Type Kennzeichen für tolerierten Luftspalt Code letter for tolerated air gap Luftspalt „Maß g“ in tausendstel Millimeter (4 Ziffern). „0000“ bei Kernen ohne Luftspalt.	Kennziffern für Material Code number for material Füllnummer Filling number Air gap “dim. g” in thousandths of millimeter (4 digits). “0000” for cores without air gap.
---	---

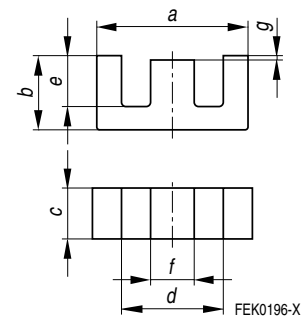

E Cores E 40 ... E 80

E-Kerne E 40 ... E 80

Typ Type	Magnetische Formkenngrößen (pro Satz) Magnetic characteristics (per set)				
	$\Sigma l/A$ mm ⁻¹	l_e mm	A_e mm ²	A_{min} mm ²	V_e mm ³
E 40/16/12 ¹⁾	0.52	77	149	143	11500
E 42/21/15	0.54	97	178	175	17300
E 42/21/20	0.41	97	234	229	22700
E 47/20/16 ¹⁾	0.38	89	233	226	20700
E 55/28/21	0.35	124	354	351	43900
E 55/28/25	0.30	124	420	420	52100
E 56/24/19 ¹⁾	0.31	107	340	327	36400
E 65/32/27	0.27	147	535	529	78600
E 70/33/32	0.22	149	683	676	102000
E 80/38/20	0.47	184	390	388	71800

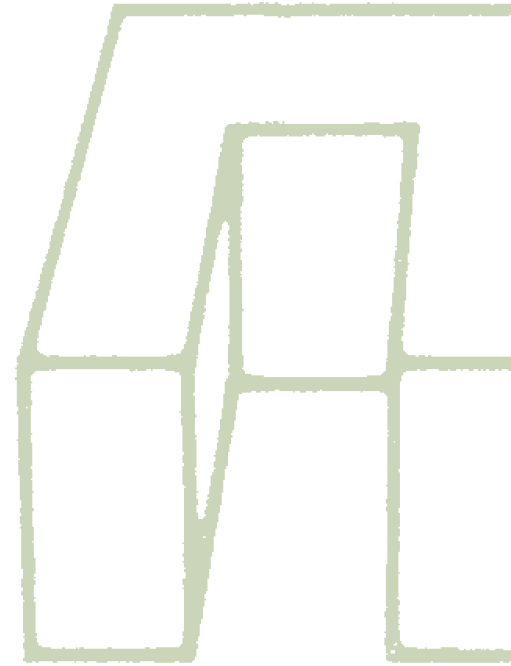

Kerne / Cores					Zubehör / Accessories			
Typ Type	Luftspalt Air gap	Material (Kennziffer / Code number) A _L -Werte (nH) bzw. Maß g (mm) für Kerne mit Luftspalt A _L values (nH) or dim.g (mm) for cores with air gap			Bestellnummer (pro Stück) Ordering code (per piece)	Spulenkörper Coil formers		
		N27 (27)	N87 (87)	N97 (97)		Kamm. Sect.	Stifte Pins	Bestellnummer Ordering code
E 40/16/12 ¹⁾	○	3800			B66381G0000X127			
E 42/21/15	○	3500	3950		B66325G0000X1**			
	●	0.1/0.25/0.5/0.64			B66325G0***X127			
	●	1.0/1.5			B66325G****X127			
E 42/21/20	○	4750	5200	5400	B66329G0000X1**	1	18	B66243A1018T001
	●	0.25/0.5			B66329G0***X127	1	12	B66243S1012T001
	●	1.0/1.5			B66329G****X127			
E 47/20/16 ¹⁾	○	5100	5600		B66383G0000X1**			
E 55/28/21	○	5800	6400	6700	B66335G0000X1**			
	●	0.5	0.5		B66335G0500X1**			
	●	1.0/1.5/2.0	1.0/1.5/2.0		B66335G****X1**			
E 55/28/25	○	6800	7300	7700	B66344G0000X1**			
	●	2.5			B66344G2500X127			
E 56/24/19 ¹⁾	○	6300			B66385G0000X127			
E 65/32/27	○	7200	7900	7900	B66387G0000X1**			
	●	0.5	0.5	0.5	B66387G0500X1**			
	●	1.0/1.5	1.0/1.5		B66387G****X1**			
E 70/33/32	○	8850	9700		B66371G0000X1**			
	●	1.5			B66371G1500X127			
E 80/38/20	○	4150	4500		B66375G0000X1**			
	●	0.5			B66375G0500X127			
A _L -Wert-Toleranz Tol. of A _L value		+30/-20%	+30/-20%	+30/-20%				

- = mit Luftspalt / gapped
- = ohne Luftspalt / ungapped

* Siehe Bestellbeispiel
See ordering code example

1) Größe entspricht U.S. lam size E cores.
Size corresponds to U.S. lam size E cores.
E 40/16/12 ≙ E 21; E 47/20/16 ≙ E 625; E 56/24/19 ≙ E 75

ELP/EQ/I Cores

ELP/EQ/I-Kerne

ELP-, EQ- und I-Kerne für besonders flache Übertragerbauformen

Planarinduktivitäten gewinnen zunehmend an Bedeutung, da sie gegenüber der herkömmlichen Wickeltechnik eine Reihe von Vorteilen bieten, wie

- geringe Bauhöhe,
- ausgezeichnete thermische Eigenschaften aufgrund der großen Kernoberfläche,
- hohe Leistungsdichte,
- hohe Reproduzierbarkeit.

Für diese Technologie stellt EPCOS entsprechende Ferritkerne bereit. Low-Profile E-Kerne (ELP), EQ- und I-Kerne sind z. B. für DC/DC- und AC-/DC-Konverter geeignet. Das Design der Low-Profile-Kerne ist in IEC 61860 festgelegt.

ELP-, EQ- und I-Kerne werden stückweise geliefert.



ELP, EQ and I cores for extra-low-profile transformer designs

Planar inductive components are taking on increasing importance because they present a number of advantages compared to

conventional winding technology, for example

- low profile,
- excellent thermal performance thanks to large core surface,
- high power density,
- high reproducibility.

EPCOS offers matching ferrite cores for this technology.

Low-profile E cores (ELP), EQ and I cores are suitable for DC/DC and AC/DC converters for instance.

Low-profile core design is specified in IEC 61860.

ELP, EQ and I cores are supplied in single units.

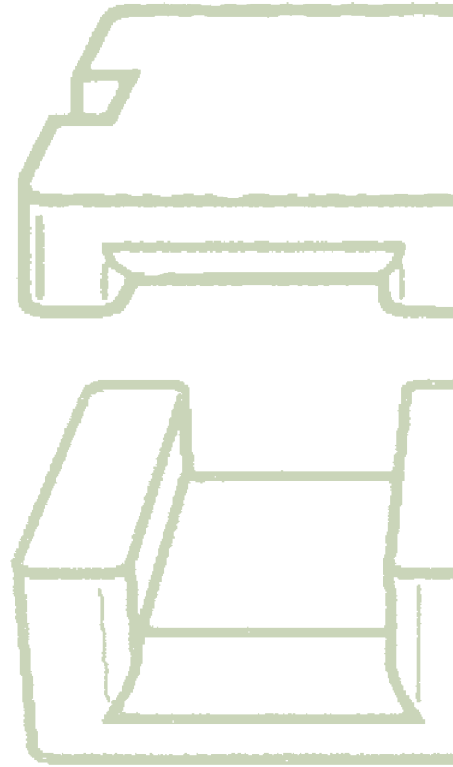

Kerne / Cores

Typ Type	Luftspalt Air gap	Material (Kennziffer / Code number) A _L -Werte (nH) / A _L values (nH)				Bestellnummer (pro Stück) Ordering code (per piece)	
		N49 (49)	N87 (87)	N92 (92)	N97 (97)		
EELP							
ELP 14 / ELP 14	○	800 ±25%	1100 ±25%	850 ±25%		B66281G0000X1**	
ELP 18 / ELP 18	○	1900 ±25%	2600 ±25%	2025 ±25%		B66283G0000X1**	
ELP 22 / ELP 22	○	3100 ±25%	4500 ±25%	3400 ±25%	4600 ±25%	B66285G0000X1**	
ELP 32 / ELP 32	○	3900 ±25%	5700 ±25%		5700 ±25%	B66287G0000X1**	
ELP 38 / ELP 38	○	4850 ±25%	7200 ±25%	5400 ±25%	7400 ±25%	B66289G0000X1**	
ELP 43 / ELP 43	○	5000 ±25%	7300 ±25%	5500 ±25%	7500 ±25%	B66291G0000X1**	
ELP 58 / ELP 58	○		7400 ±25%			B66293G0000X187	
ELP 64 / ELP 64	○	8000 ±30%	12500 ±25%		12500 ±25%	B66295G0000X1**	
EILP							
		N49 (49)	N87 (87)	N92 (92)	N97 (97)	ELP-Kern / ELP core	I-Kern / I core
ELP 14 / I 14	○	850 ±25%	1250 ±25%	900 ±25%		B66281G0000X1**	B66281P0000X1**
ELP 18 / I 18	○	2100 ±25%	2900 ±25%	2300 ±25%	3000 ±25%	B66283G0000X1**	B66283P0000X1**
ELP 22 / I 22	○	3700 ±25%	5200 ±25%	4000 ±25%	5250 ±25%	B66285G0000X1**	B66285P0000X1**
ELP 32 / I 32	○	4400 ±25%	6300 ±25%	4800 ±25%	6300 ±25%	B66287G0000X1**	B66287P0000X1**
ELP 38 / I 38	○	5700 ±25%	8300 ±25%	6200 ±25%	8400 ±25%	B66289G0000X1**	B66289P0000X1**
ELP 43 / I 43	○	5900 ±25%	8500 ±25%	6400 ±25%	8700 ±25%	B66291G0000X1**	B66291P0000X1**
ELP 58 / I 58	○		8400 ±25%			B66293G0000X187	B66293P0000X187
ELP 64 / I 64	○	8900 ±30%	14000 ±25%		14000 ±25%	B66295G0000X1**	B66295P0000X1**
EQ / I							
		–	–	N92 (92)	N97 (97)	EQ-Kern / EQ core	I-Kern / I core
EQ 13/3; I 13/1	○	–	–	1550 ±25%	1750 ±25%	B66479G0000X1**	B66479P0000X1**
EQ 20/6; I 20/2	○	–	–	3400 ±25%	4400 ±25%	B66483G0000X1**	B66483P0000X1**
EQ 25/6; I 25/2	○	–	–	4450 ±25%	5750 ±25%	B66481G0000X1**	B66481P0000X1**
EQ 30/8; I 30/3	○	–	–	4600 ±25%	6000 ±25%	B66506G0000X1**	B66506P0000X1**

○ = ohne Luftspalt / ungapped

** Kennziffer für Werkstoff
Code number for material

ETD Cores

ETD-Kerne

ETD-Kerne nach IEC 61185 (Economic Transformer Design)

ETD-Kerne eignen sich hervorragend für den Aufbau von Schaltnetzteil-übertragern mit optimaler gewichtsbezogener Leistung bei kleinem Volumen.

Der runde Mittelschenkel ist vorteilhaft bei Verwendung dicker Drähte oder Bänder.

ETD-Kerne zeichnen sich durch einen besonders großen Wickelraum aus.

Es steht ein optimiertes Zubehör zur Verfügung.

ETD-Kerne entsprechen IEC 61185. Sie werden stückweise geliefert.

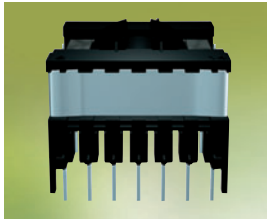

ETD cores to IEC 61185 (Economic Transformer Design)

ETD cores are an excellent solution for designing switch-mode power supply transformers with optimum power/weight ratio for low volume.

The round center leg is an advantage together with thick wires or bands.

ETD cores are characterized by an wide opening for winding. Optimized accessories are available.

ETD cores are in accordance with IEC 61185.

They are supplied in single units.



Kerne / Cores					Zubehör / Accessories			
Typ Type	Luftspalt Air gap	Material (Kennziffer / Code number) A _L -Werte (nH) ¹⁾ bzw. Maß g (mm) für Kerne mit Luftspalt A _L values (nH) ¹⁾ or dim. g (mm) for cores with air gap			Bestellnummer (pro Stück) Ordering code (per piece)	Spulenkörper Coil formers		
		N27 (27)	N87 (87)	N97 (97)		Kammern Sections	Stifte Pins	Bestellnummer Ordering code
ETD 29/16/10	○	2000	2200	2250	B66358G0000X1**	1	13	B66359B1013T001
	●	0.1/0.2/0.5	0.1/0.2/0.5	0.1/0.2/0.5	B66358G0***X1**	1	13	B66359A1013T001
	●	1.0	1.0	1.0	B66358G1000X1**	1	13	B66359W1013T001
						1	14	B66359X1014T001
ETD 34/17/11	○	2400	2600	2650	B66361G0000X1**	1	14	B66362B1014T001
	●	0.1/0.2/0.5	0.1/0.2/0.5	0.1/0.2/0.5	B66361G0***X1**	1	14	B66362W1014T001
	●	1.0	1.0	1.0	B66361G1000X1**	1	14	B66362X1014T001
ETD 39/20/13	○	2550	2700	2800	B66363G0000X1**	1	16	B66364B1016T001
	●	0.1/0.2/0.5	0.1/0.2/0.5	0.1/0.2/0.5	B66363G0***X1**	1	16	B66364W1016T001
	●	1.0	1.0	1.0	B66363G1000X1**			
ETD 44/22/15	○	3300	3500	3600	B66365G0000X1**	1	18	B66366B1018T001
	●	0.2/0.5	0.2/0.5	0.2/0.5	B66365G0***X1**	1	18	B66366W1018T001
	●	1.0/1.5	1.0/1.5	1.0/1.5	B66365G***X1**			
ETD 49/25/16	○	3700	3800	3900	B66367G0000X1**	1	20	B66368B1020T001
	●	0.2/0.5	0.2/0.5	0.2/0.5	B66367G0***X1**	1	20	B66368W1020T001
	●	1.0/2.0	1.0/2.0	1.0/2.0	B66367G***X1**			
ETD 54/28/9	○	4200	4450	4600	B66395G0000X1**	1	22	B66396W1022T001
	●	0.2	0.2	0.2	B66395G0200X1**			
	●	1.0/1.5/2.0	1.0/1.5/2.0	1.0/1.5/2.0	B66395G***X1**			
ETD 59/31/22	○	5000	5300	5500	B66397G0000X1**			
	●	0.2	0.2	0.2	B66397G0200X1**	1	24	B66398W1024T001
	●	1.0/1.5/2.0	1.0/1.5/2.0	1.0/1.5/2.0	B66397G***X1**			

- = mit Luftspalt / gapped
- = ohne Luftspalt / ungapped

1) A_L-Wert-Toleranz: +30/-20%
Tolerance of A_L value: +30/-20%

* Siehe Bestellbeispiel
See ordering code example

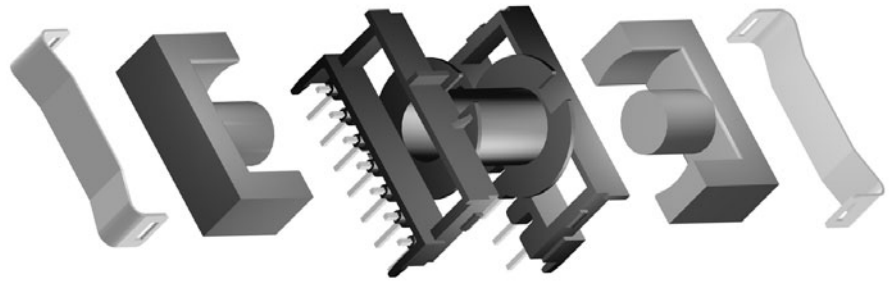

Typ Type	Magnetische Formkenngrößen (pro Satz) Magnetic characteristics (per set)				
	$\Sigma I/A$ mm ⁻¹	l_e mm	A_e mm ²	A_{min} mm ²	V_e mm ³
ETD 29	0.93	70.4	76.0	71.0	5350
ETD 34	0.81	78.6	97.1	91.6	7630
ETD 39	0.74	92.2	125	123	11500
ETD 44	0.60	103	173	172	17800
ETD 49	0.54	114	211	209	24100
ETD 54	0.45	127	280	280	35600
ETD 59	0.38	139	368	368	51200

Magn. Achse (Material) Magnetic axis (material)	Bügel (2 Stück erforderlich) Yokes (2 pieces required)
horizontal (Valox 420 SE0) horizontal (Valox 420 SE0)	B66359A2000
horizontal (Rynite FR 530) vertical (Rynite FR 530)	
horizontal (Valox 420 SE0) horizontal (Rynite FR 530) vertical (Rynite FR 530)	B66362A2000
horizontal (Valox 420 SE0) horizontal (Rynite FR 530)	B66364A2000
horizontal (Valox 420 SE0) horizontal (Rynite FR 530)	B66366A2000
horizontal (Valox 420 SE0) horizontal (Rynite FR 530)	B66368A2000
horizontal (Rynite FR 530)	B66396A2000
horizontal (Rynite FR 530)	B66398A2000

Typ Type	Hauptmaße (mm) Main dimensions (mm)					
	a	b	c	d ₁	d ₂	e
ETD 29	30.6 -1.6	16.0 -0.4	9.8 -0.6	22.0 +1.4	9.8 -0.6	10.7 +0.6
ETD 34	34.0 +1/-0.6	17.5 -0.4	11.1 -0.6	25.6 +1.4	11.1 -0.6	11.8 +0.6
ETD 39	38.9 +1.1/-0.7	20.0 -0.4	12.8 -0.6	29.3 +1.6	12.8 -0.6	14.2 +0.8
ETD 44	43.8 +1.2/-0.8	22.5 -0.4	15.2 -0.8	32.5 +1.6	15.2 -0.8	16.1 +0.8
ETD 49	48.5 +1.3/-0.9	24.9 -0.4	16.7 -0.8	36.1 +1.8	16.7 -0.8	17.7 +0.8
ETD 54	54.5 ±1.3	27.8 -0.4	19.3 -0.8	40.1 +2.2	19.3 -0.8	19.8 +0.8
ETD 59	59.8 ±1.4	31.2 -0.4	22.1 -0.9	43.6 +2.2	22.1 -0.9	22.0 +0.9

Bestellbeispiel
Ordering code example

B66358G1000X127

Bauform Type	Kennziffern für Material Code number for material
Kennzeichen für tolerierten Luftspalt Code letter for tolerated air gap	Füllnummer Filling number
Luftspalt „Maß g“ in tausendstel Millimeter (4 Ziffern). „0000“ bei Kernen ohne Luftspalt.	Air gap „dim. g“ in thousandths of millimeter (4 digits). „0000“ for cores without air gap.

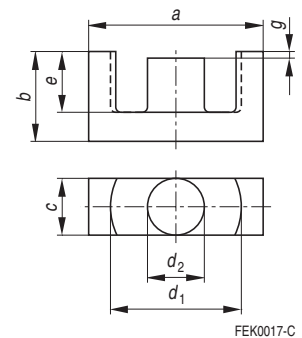

FEK0017-C

ER Cores

ER-Kerne

ER-Kerne mit rundem Mittelschenkel

ER-Kerne sind ideal, wenn kompakte Wickelaufbauten mit kleiner Streuinduktivität gefordert werden. Der runde Mittelschenkel ist vorteilhaft bei Verwendung dicker Drähte oder Bänder. Diese Kernform findet Anwendung in Sperrwandlern (Flyback) bei TV und Monitoren.

ER 9.5 und ER 11/5 eignen sich besonders für den Aufbau von Übertragern mit niedriger Bauhöhe und hoher Induktivität. Hier steht auch ein Zubehör für Oberflächenmontage zur Verfügung.

ER 9.5 ... ER 14.5 werden satzweise, ER 28 ... ER 54 werden stückweise geliefert.

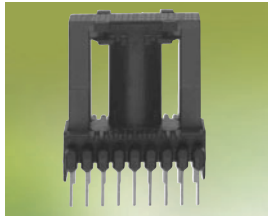

ER cores with round center leg

ER cores are the ideal answer when compact winding structures with low leakage inductance are needed. The round center leg is an advantage together with thick wires or bands. This kind of core is used in flyback converters for TVs and monitors.

ER 9.5 and ER 11/5 are especially suitable for transformer designs with low total height and high inductance. Also available are accessories for surface mounting.

ER 9.5 ... 14.5 are supplied in sets, ER 28 through ER 54 in single units.



Kerne / Cores									Zubehör / Accessories		
Typ Type	Luftspalt Air gap	Material (Kennziffer / Code number)							Bestellnummer (pro Satz) Ordering code (per set)	Spulenkörper Coil formers	
		A _L -Werte (nH)/Toleranz ¹⁾ bzw. Maß g (mm) für Kerne mit Luftspalt A _L values (nH)/tolerance ¹⁾ or dim. g (mm) for cores with air gap								Kammern Sections	Stifte Pins
		T38 (38)	N27 (27)	N49 (49)	N72 (72)	N87 (87)	N92 (92)	N97 (97)			
ER 9.5/5	○	4500 Y					800 R		B65523J0000Y038 B65523J0000R087	1	SMD 8
ER 11/5	○	6400 Y	800 R			1200 R		1200	B65525J0000Y038 B65525J0000R049 B65525J0000R0** B65525J0160A087	1	SMD 10
ER 14.5/6	○		1100 R			1500 R	1100 R		B65513F0000R0**		
									Bestellnummer (pro Stück) Ordering code (per piece)		
ER 18/3/10	○			1800 R		2300 ±25	1800 ±25	2300 ±25	B66480G0000X1**		
ER 23/5/13	○			2600 R		3400 ±25	2600 ±25	3400 ±25	B66482G0000X1** B66482P0000X1**		
I 23/2/13	○										
ER 25/6/15	○			3400 R		4600 ±25	3400 ±25	4600 ±25	B66484G0000X1** B66484P0000X1**		
I 25/3/15	○										
ER 32/5/21	○							5000 R	B66501G0000X197		
ER 28/17/11	○				2700 R				B66433G0000X172		
ER 35/20/11	○		2500 R						B66350G0000X127 B66350G0500X127 B66350G1***X127		
	●		0.5								
	●		1.0/1.5								
ER 42/22/15	○		3200 R			3700 R		3500 R	B66347G0000X1** B66347G1000X127	1	18
	●		1.0								
ER 46/17/18	○		5700 R						B66377G0000X127 B66377G1000X127		
	●		1.0								
ER 49/27/17	○		3500 R						B66391G0000X127		
ER 54/18/18	○		5600 R			5800 R		5750 R	B66357G0000X1** B66357G0500X127		
	●		0.5								

● = mit Luftspalt / gapped / ○ = ohne Luftspalt / ungapped

1) Kennbuchstabe für A_L-Toleranz: R ± +30/-20%, Y ± +40/-30%
Code for A_L tolerance: R ± +30/-20%, Y ± +40/-30%

* Siehe Bestellbeispiel, Seite 43
See ordering code example, page 43

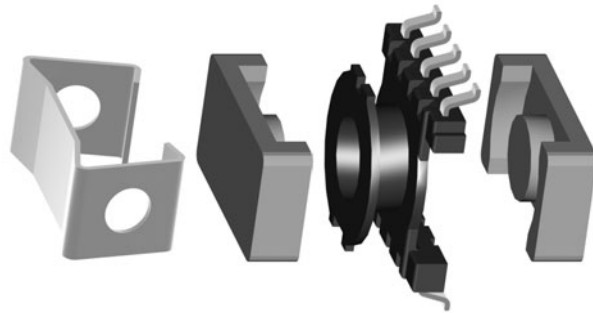

Beispiel: ER 11/5
Example: ER 11/5

Typ Type	Magnetische Formkenngrößen (pro Satz) Magnetic characteristics (per set)				
	$\Sigma I/A$ mm ⁻¹	l_e mm	A_e mm ²	A_{min} mm ²	V_e mm ³
ER 9.5	1.58	13.3	8.41	–	120
ER 11/5	1.10	14.0	12.7	–	178
ER 14.5	1.10	19.0	17.6	–	333
ER 18	0.73	22.1	30.2	30.1	667
ER 23/I 23	0.531	26.6	50.2	50.0	1340
ER 25/I 25	0.40	28.1	70.4	69.4	1980
ER 28	0.88	75.0	85.4	77.0	6400
ER 32/5/21	0.346	38.0	109.8	98.5	4177
ER 35	0.81	89.6	111	101	9930
ER 42	0.58	99	170	170	16800
ER 46	0.34	79	233	226	18400
ER 49	0.49	118	243	225	28700
ER 54	0.35	90	256	252	23000

Bestellnummer Ordering code	Merkmale Features	Bügel Yoke
B65527B1008T001	Gullwing terminals	B65527A2000
B65526B1010T001	Gullwing terminals	B65526A2000

Typ Type	Hauptmaße (mm) / Main dimensions (mm)							
	a	c	d ₁	d ₂	l ₁	l ₂		
ER 9.5	9.5 -0.3	5 -0.2	7.5 +0.25	3.5 -0.2	5 -0.2	3.2 +0.3		
ER 11/5	11 -0.35	6 -0.2	8.7 +0.3	4.25 -0.2	5 -0.2	3.0 +0.3		
ER 14.5	14.5 +0.2	6.7 +0.1	11.8 +0.2	4.7 +0.1	5.7 +0.1	3.3 +0.2		
ER 18	18 +0.35	9.7 +0.2	15.6 +0.3	6.2 +0.15	3.15 +0.1	1.6 +0.1		
ER 23 I 23	23.2 ±0.45	12.5 ±0.25	20.2 ±0.4	8.0 ±0.2	5.1 +0.1 2.1 +0.1	3.1 +0.1 0.2 max.		
ER 25 I 25	25 ±0.5	14.8 ±0.3	21.7 ±0.4	9.4 ±0.2	5.5 +0.1 2.5 +0.1	3.1 ±0.1 0.2 max.		
ER 28	28.55 ±0.55	11.4 +0.25	21.75 +0.5	9.9 +0.25	16.9 +0.2	12.6 +0.3		
ER 32	32 +0.6	21.0 +0.4	29.7 +0.5	11.2 +0.2	5.1 +0.1	2.7 +0.1		
ER 35	35 +0.6	11.3 +0.2	25.6 min	11.3 +0.2/-0.25	20.7 +0.3	14.7 +0.3		
ER 42	42 +1/-0.7	15.0 -0.6	30.4 +1.2	15.0 -0.6	21.8 -0.4	15.6 +0.7		
ER 46	46 -2	18.0 -0.8	33.0 +1.6	18.0 -0.8	17.5 -0.4	10.5 +0.5		
ER 49	49 ±1	17.2 +0.4	37.3 +0.9	17.2 +0.4	27.0 +0.3	18.5 +0.4		
ER 54	53.5 ±1	18.3 -0.7	39.8 +1.7	18.3 -0.8	18.5 -0.4	10.8 +0.6		

Prinzipmaßbilder/Schematic representations

ER 9.5 ... ER 14.5/6

ER 18 ... ER 25, ER 32

ER 28 ... ER 54

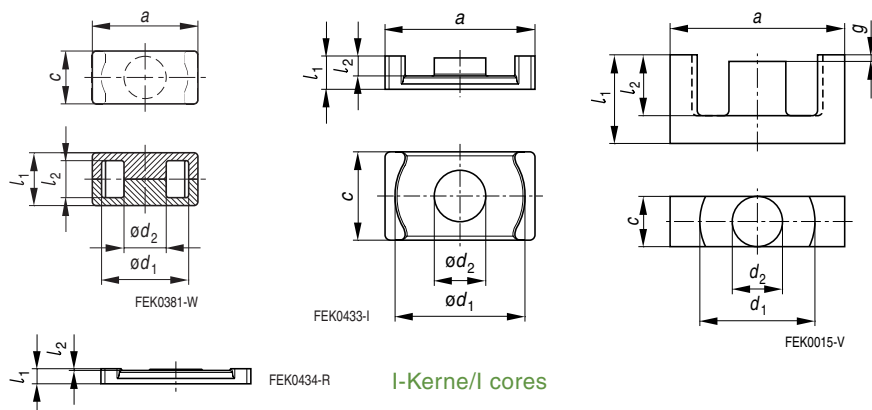

I-Kerne/I cores

EFD/EV Cores

EFD/EV-Kerne

E-Kerne für besonders flache Übertrager-Bauformen

Die querschnittsoptimierten EFD- und EV-Kerne besitzen einen abgeflachten, tiefer gelegten Mittelschenkel. Damit lassen sich sehr flache und kompakte Trafos für hochfrequente Anwendungen realisieren. EFD- und EV-Kerne werden für DC/DC-Konverter verwendet, EV-Kerne sind auch für Speicher- und Entstördrosseln geeignet.

Alle Kerne werden stückweise geliefert.

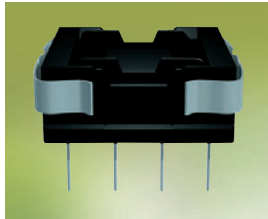

E cores for extra-low-profile transformer designs

EFD and EV cores are optimized in cross-section and feature a flattened, lowered center leg. That allows implementation of very flat, compact

transformers for RF applications. EFD and EV cores are used for DC/DC converters, EV cores are additionally suitable for storage chokes and EMI suppression

chokes.

These cores are supplied in single units.



Kerne / Cores						Zubehör / Accessories			
Typ Type	Luftspalt Air gap	Material (Kennziffer / Code number) A _L -Werte (nH) / A _L values (nH)				Bestellnummer (pro Stück) Ordering code (per piece)	Spulenkörper ¹⁾ Coil formers ¹⁾		
		N27 (27)	N49 (49)	N87 (87)	N97 (97)		Kamm. Sections	Stifte Pins	Bestellnummer Ordering code
EFD 10	○		370 +30/-20%	450 +30/-20%		B66411G0000X1**			
EFD 15	○		600 +30/-20%	780 +30/-20%	820 +30/-20%	B66413G0000X1**	1	8	B66414W1008D001
	●			100 ±10%		B66413U0100K187			
	●			160 ±15%		B66413U0160L187	SMD 1	8	B66414B6008T001
EFD 20	○		910 +30/-20%	1200 +30/-20%	1250 +30/-20%	B66417G0000X1**	1	8	B66418W1008D001
	●			100 ±10%		B66417U0100K187			
	●			160 ±10%		B66417U0160K187			
EFD 25	○			2000 +30/-20%	2100 +30/-20%	B66421G0000X1**	1	10	B66422W1010D001
	●			160 ±10%		B66421U0160K187			
	●			250 ±10%		B66421U0250K187			
	●			315 ±10%		B66421U0315K187			
EFD 30	○			2050 +30/-20%	2150 +30/-20%	B66423G0000X1**	1	12	B66424W1012D001
	●			160 ±10%		B66423U0160K187			
	●			250 ±10%		B66423U0250K187			
	●			315 ±10%		B66423U0315K187			
EV 15/9/7	○	1150 ±25%		1250 ±25%	1300 ±25%	B66434G0000X1**			
EV 25/13/13	○	2400 +30/-20%		2500 +30/-20%	2600 +30/-20%	B66408G0000X1**			
EV 30/16/13	○	2600 +30/-20%		2800 +30/-20%	2700 +30/-20%	B66432G0000X1**			

- = mit Luftspalt / gapped
- = ohne Luftspalt / ungapped

** Kennziffer für Werkstoff
Code number for material

1) Stiftvarianten für EFD-Spulenkörper auf Anfrage.
Pin versions for EFD coil formers upon request.

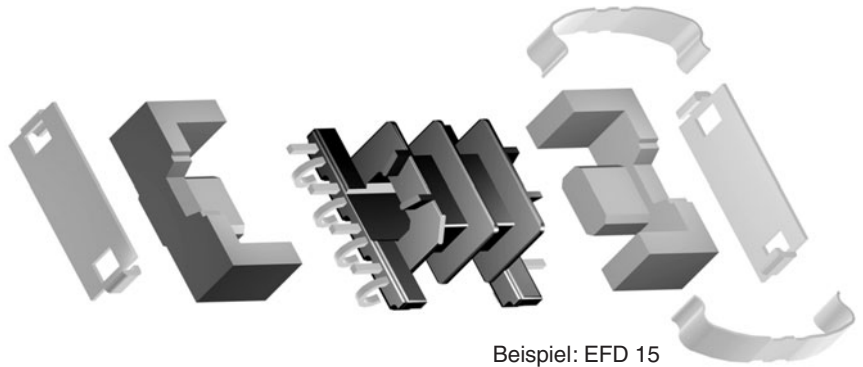

Beispiel: EFD 15
Example: EFD 15

Typ Type	Magnetische Formkenngrößen (pro Satz) Magnetic characteristics (per set)				
	$\Sigma I/A$ mm ⁻¹	l_e mm	A_e mm ²	A_{min} mm ²	V_e mm ³
EFD 10	3.21	23.1	7.2	6.5	166
EFD 15	2.27	34	15	12.2	510
EFD 20	1.52	47	31	31	1460
EFD 25	0.98	57	58	57	3310
EFD 30	0.99	68	69	69	4690
EV 15	1.4	38.7	27.7	25.8	1070
EV 25	0.8	59	74	73	4370
EV 30	0.76	74.8	99	95	7410

Merkmale Features	Bügel (2 Stück erforderlich) Yokes (2 pieces required)
Stifte / PTH	B66414B2000
J terminals	B66414B2000 B66414A7000 (Abdeckplatte / Cover plate)
Stifte / PTH	B66418B2000
Stifte / PTH	B66422B2000
Stifte / PTH	B66424B2000

Typ Type	Hauptmaße (mm) Main dimensions (mm)						
	a	b	c	d ₁	d ₂	e	f
EFD 10	10.5 ±0.3	5.2 ±0.1	2.7 ±0.1	7.65 ±0.25	4.55 ±0.15	3.75 ±0.15	1.45 ±0.05
EFD 15	15 ±0.4	7.5 ±0.15	4.65 ±0.15	11.0 ±0.35	5.3 ±0.15	5.5 ±0.25	2.4 ±0.10
EFD 20	20 ±0.55	10.0 ±0.15	6.65 ±0.15	15.4 ±0.5	8.9 ±0.2	7.7 ±0.25	3.6 ±0.15
EFD 25	25 ±0.65	12.5 ±0.15	9.1 ±0.2	18.7 ±0.6	11.4 ±0.2	9.3 ±0.25	5.2 ±0.15
EFD 30	30 ±0.8	15.0 ±0.15	9.1 ±0.2	22.4 ±0.75	14.6 ±0.25	11.2 ±0.3	4.9 ±0.15

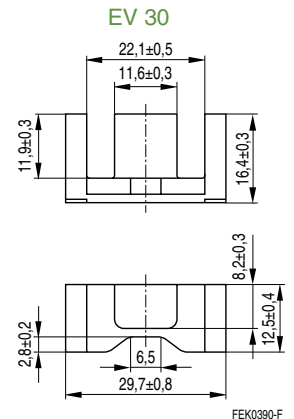
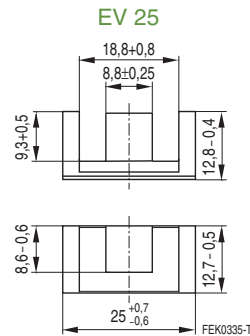
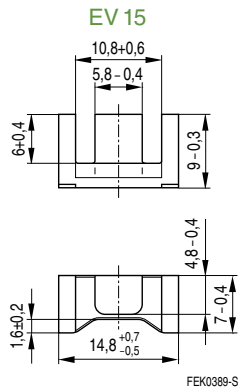
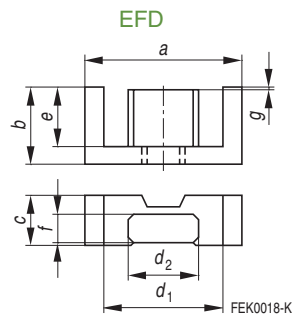

Toroids R 2.5 ... R 22.1

Ringkerne R 2.5 ... R 22.1

Ringkerne für EMV- und LAN-Anwendungen

Ringkerne werden schwerpunktmäßig als EMV-Drosseln zur Unterdrückung von HF-Störungen im MHz-Bereich und für Signalübertrager verwendet.

Typische Applikationen für Ringkerne aus NiZn-Ferriten sind LAN-Drosseln. Hier eignet sich besonders K10. Weitere Werkstoffe sind auf Anfrage erhältlich.



Auswahl an hochpermeablen MnZn-Werkstoffen im Bereich Störschutz:

- R 2.5 bis R 12.5 für Telekommunikation, z.B. ISDN (N30, T38, T46)
- R 2.5 bis R 3.94 für LAN (T57)
- R 13.3 bis R 25.3 für Netzleitungs-drosseln (N30, T65, T35 ... T46)
- > R 34 für Drosseln und Filter in Industrieanwendungen (T65)

Toroidal cores for EMC and LAN applications

Toroidal cores are primarily used as EMC chokes for suppressing RF interference in the MHz region and in signal transformers.

Typical applications for toroids of NiZn ferrites are LAN chokes. One of the materials available for this purpose is K10; other materials upon request.

High-permeability MnZn materials for interference suppression:

- R 2.5 through R 12.5 for telecommunications, e.g. ISDN (N30, T38, T46)
- R 2.5 through R 3.94 for LAN (T57)
- R 13.3 through R 25.3 for power line chokes (N30, T65, T35 to T46)
- > R 34 for chokes and filters in industrial use (T65)

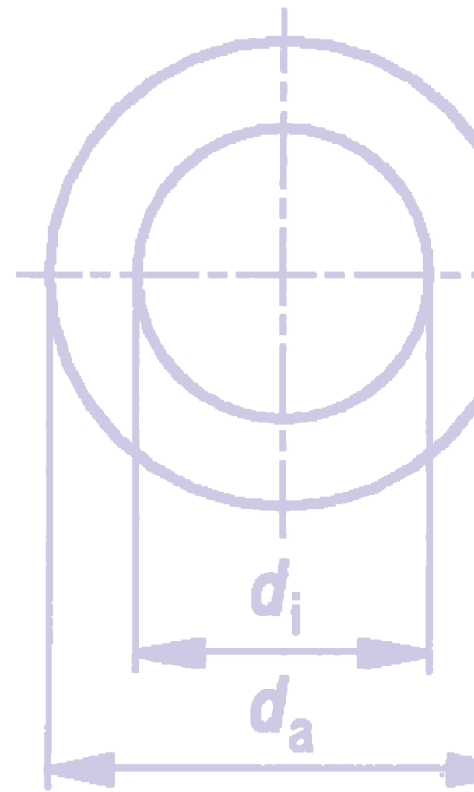

Ringkerne / Toroids

Typ Type		Ange- presste Phase	Werkstoff / (Kennziffer für Bestellnummer, Block 3) Material / (Code number for ordering code, Block 3)										
Ringkerngröße (d _a x d _i x h) Toroid size (d _a x d _i x h)			Chamfer	A _L -Werte (nH) / Anfangspermeabilität μ _i (ca.) A _L values (nH) / approx. initial permeability μ _i									
mm	inch	K10 (X010)		N30 (X830)		T57 (X057)		T65 (X065)		T35 (X035)			
		A _L	μ _i	A _L	μ _i	A _L	μ _i	A _L	μ _i	A _L	μ _i		
R 2.50 x 1.50 x 1.00	R 0.098 x 0.059 x 0.039		70	700			410	4000	470	4600			
R 2.54 x 1.27 x 1.27	R 0.100 x 0.050 x 0.050		120	700			690	3900	800	4500			
R 3.05 x 1.27 x 1.27	R 0.120 x 0.050 x 0.050		160	700			830	3700	1000	4500			
R 3.05 x 1.27 x 2.54	R 0.120 x 0.050 x 0.100		330	700			1700	3800	2000	4500			
R 3.05 x 1.78 x 2.03	R 0.120 x 0.070 x 0.080		160	700			870	4000	1000	4600			
R 3.43 x 1.78 x 1.78	R 0.135 x 0.070 x 0.070		160	700			930	4000	1050	4500			
R 3.43 x 1.78 x 2.03	R 0.135 x 0.070 x 0.080		190	700			1060	4000	1200	4500			
R 3.43 x 1.78 x 2.11	R 0.135 x 0.070 x 0.083		200	700			1100	4000	1300	4700			
R 3.94 x 1.78 x 1.78	R 0.155 x 0.070 x 0.070		200	700			1100	3900	1350	4800			
R 3.94 x 2.24 x 1.30	R 0.155 x 0.088 x 0.051		100	700			550	3800	700	4800			
R 4.00 x 2.40 x 1.60	R 0.157 x 0.094 x 0.063				700	4300			750	4600			
R 5.84 x 3.05 x 3.00	R 0.230 x 0.120 x 0.118				1680	4300			1800	4600			
R 6.30 x 3.80 x 2.50	R 0.248 x 0.150 x 0.098				1090	4300			1160	4600			
R 9.53 x 4.75 x 3.17	R 0.375 x 0.187 x 0.125				1900	4300			2050	4600	2650	6000	
R 10.0 x 6.00 x 4.00	R 0.394 x 0.236 x 0.157	X			1760	4300			1900	4700	2460	6000	
R 12.5 x 7.50 x 5.00	R 0.492 x 0.295 x 0.197	X			2200	4300			2400	4700	3060	6000	
R 12.7 x 7.90 x 6.35	R 0.500 x 0.311 x 0.250	X			2600	4300			2850	4700	3620	6000	
R 13.3 x 8.30 x 5.00	R 0.524 x 0.327 x 0.197	X			2030	4300			2300	4900	2830	6000	
R 14.0 x 9.00 x 5.00	R 0.551 x 0.354 x 0.197	X			1900	4300			2300	5200	2650	6000	
R 15.0 x 10.4 x 5.30	R 0.591 x 0.409 x 0.209				1670	4300			2020	5200	2330	6000	
R 15.8 x 8.90 x 4.70	R 0.622 x 0.350 x 0.185	X			2320	4300			2800	5200	3240	6000	
R 16.0 x 9.60 x 6.30	R 0.630 x 0.378 x 0.248	X			2770	4300			3350	5200	3870	6000	
R 17.0 x 10.7 x 6.80	R 0.669 x 0.421 x 0.268	X			2710	4300			3250	5200	3770	6000	
R 18.4 x 5.90 x 5.90	R 0.724 x 0.232 x 0.232	X			5770	4300			6680	5000	8020	6000	
R 20.0 x 10.0 x 7.00	R 0.787 x 0.394 x 0.276	X			4160	4300			5050	5200	5000	5100	
R 22.1 x 13.7 x 6.35	R 0.870 x 0.539 x 0.250	X			2610	4300			3160	5200	3200	5300	
R 22.1 x 13.7 x 7.90	R 0.870 x 0.539 x 0.311	X			3250	4300			3930	5200	4000	5300	
R 22.1 x 13.7 x 12.5	R 0.870 x 0.539 x 0.492	X			5140	4300			6200	5200	6000	5000	
A _L -Wert-Toleranz Tolerance of A _L value			±25%		±25%		±25%		±30%		±25%		

Bildung der Bestellnummer Compilation of ordering code

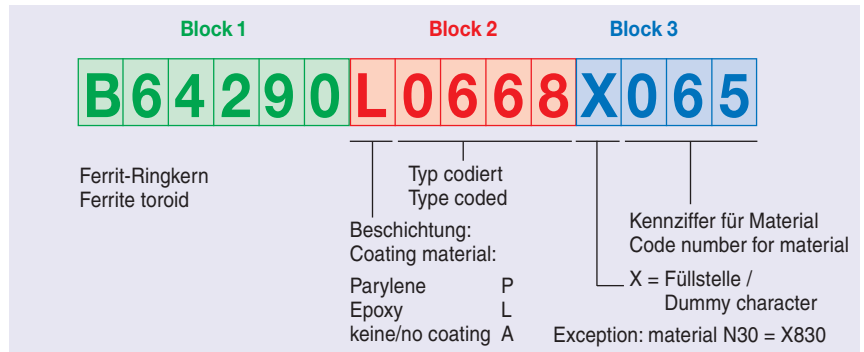

Beschichtung von Ringkernen Coatings of ring cores

Ausführung Version	Epoxy (blau) Epoxy (blue)	Galxyl (Parylene) Galxyl (Parylene)
Schichtdicke Layer thickness	< 0,4 mm < 0.4 mm	0.012 oder 0.025 mm 0.012 or 0.025 mm
Durchbruchspannung Breakdown voltage	> 2 kV (> R 20) > 2 kV (> R 20)	> 1 kV (Standardwert) > 1 kV (standard value)
Mechan. Beschaffenheit Mechanical voltage	Hohe Festigkeit High firmness	Glatte Oberfläche Smooth surface
Maximale Temperatur (kurzzeitig) Maximum temperature (short-time)	ca. 180°C approx. 180°C	ca. 130°C approx. 130°C
Vorteil Advantage	Geringer Einfluss auf A _L -Wert Low influence on A _L value	Geringe Schichtdicke Very low thickness
UL-Zulassung UL rating	UL 94V-0	UL 94V-0
Bestellnummer Ordering code	B64290L...	B64290P...

EMI Suppression

						Bestellnummer Ordering code		
T37 (X037)		T38 (X038)		T46 (X046)		Block1	Block2	Block3
A _L	μ _i	A _L	μ _i	A _L	μ _i			
		1020	10000	1530	15000	B64290	P0035	X***
		1760	10000	2640	15000	B64290	P0734	X***
		2200	9900	3340	15000	B64290	P0683	X***
		4200	9400	6500	15000	B64290	P0739	X***
		2150	9900	3250	15000	B64290	P0733	X***
		2300	10000	3400	15000	B64290	P0731	X***
		2650	10000	4000	15000	B64290	P0745	X***
		2770	10000	4000	15000	B64290	P0709	X***
		2830	10000	4200	15000	B64290	P0732	X***
		1470	10000	2200	15000	B64290	P0061	X***
		1630	10000	2450	15000	B64290	P0036	X***
		3900	10000	5850	15000	B64290	P0687	X***
		2530	10000	3600	14000	B64290	P0037	X***
		4410	10000	6400	15000	B64290	L0062	X***
2660	6500	4090	10000	6000	15000	B64290	L0038	X***
3320	6500	5110	10000			B64290	L0044	X***
3920	6500	6030	10000			B64290	L0742	X***
3060	6500	4700	10000			B64290	L0644	X***
2880	6500	4420	10000			B64290	L0658	X***
2520	6500	3880	10000			B64290	L0623	X***
3500	6500	5400	10000			B64290	L0743	X***
4190	6500	6440	10000			B64290	L0045	X***
4080	6500	6280	10000			B64290	L0652	X***
8690	6500	13400	10000			B64290	L0697	X***
6280	6500	9740	10000			B64290	L0632	X***
3950	6500	6070	10000			B64290	L0638	X***
4900	6500	7570	10000			B64290	L0719	X***
7770	6500	12000	10000			B64290	L0651	X***
±25%		±30%		±30%				

Magnetische Formkenngrößen Magnetic characteristics			
ΣI/A mm ⁻¹	I _e mm	A _e mm ²	V _e mm ³
12.30	6.02	0.49	3.00
7.14	5.53	0.77	4.29
5.65	5.99	1.06	6.4
2.82	5.99	2.12	12.7
5.75	7.23	1.26	9.1
5.38	7.63	1.42	10.7
4.72	7.63	1.62	12.2
4.54	7.63	1.68	12.7
4.44	8.10	1.82	14.8
8.56	9.21	1.08	9.9
7.96	9.63	1.25	12.0
3.22	13.03	4.04	52.6
4.97	15.21	3.06	46.5
2.85	20.72	7.28	151
3.07	24.07	7.83	188
2.46	30.09	12.23	368
2.08	31.17	14.96	466
2.67	32.70	12.27	401
2.84	34.98	12.30	430
3.24	39.02	12.05	470
2.33	36.75	15.78	580
1.95	38.52	19.73	760
2.00	42.00	21.04	884
0.94	31.03	33.14	1029
1.30	43.55	33.63	1465
2.07	54.15	26.17	1417
1.66	54.15	32.55	1763
1.05	54.15	51.15	2789

Toroids R 22.6 ... R 202

Ringkerne R 22.6 ... R 202

Angepresste Phase

Für große Ringkerne werden dicke Drähte verwendet, die bei der Bewicklung teilweise hoher mechanischer Belastung ausgesetzt sind. Dadurch kann die Isolierung der Drähte, aber auch die Beschichtung der Kerne beschädigt und die Durchbruchspannung verringert werden. Um dies zu vermeiden, haben Ringkerne von EPCOS mit Durchmesser > 10 mm eine angepresste Phase. Diese vermeidet Isolationschäden und ermöglicht zudem eine gleichmäßige Beschichtungsdicke.



Chamfer

Large toroidal cores use thick wires that are partially subjected to high mechanical stress during winding. This can damage the wire insulation as well as the coating of the cores, thus reducing the breakdown voltage. To avoid this, EPCOS ring cores with diameters of more than 10 mm have a chamfer. This prevents any insulation damage, and produces uniform coating thickness at the same time.

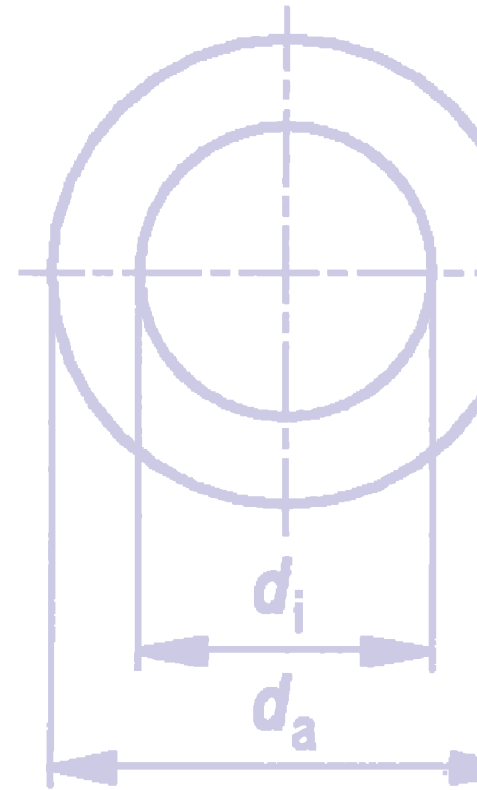

Ringkerne / Toroids

Typ Type		Angepresste Phase Chamfer	Werkstoff / (Kennziffer für Bestellnummer, Block 3) Material / (Code number for ordering code, Block 3)							
Ringkerngröße (d _a x d _i x h) Toroid size (d _a x d _i x h)			A _L -Werte (nH) / Anfangspermeabilität μ _i (ca.) A _L values (nH) / approx. initial permeability μ _i							
mm	inch		N30 (X830)		T65 (X065)		T35 (X035)		T37 (X037)	
			A _L	μ _i	A _L	μ _i	A _L	μ _i	A _L	μ _i
R 22.6 x 14.7 x 9.20	R 0.890 x 0.579 x 0.362	X	3420	4300	4100	5200	4200	5300	5170	6500
R 25.3 x 14.8 x 10.0	R 0.996 x 0.583 x 0.394	X	4620	4300	5350	5000	5400	5000	6970	6500
R 25.3 x 14.8 x 20.0	R 0.996 x 0.583 x 0.787	X	9160	4300	10600	5000	10700	5000	13800	6400
R 29.5 x 19.0 x 14.9	R 1.142 x 0.748 x 0.587	X	5630	4300	6800	5200			8500	6500
R 30.5 x 20.0 x 12.5	R 1.201 x 0.787 x 0.492	X	4540	4300	5400	5100			6400	6100
R 34.0 x 20.5 x 10.0	R 1.339 x 0.807 x 0.394	X	4360	4300	5100	5000			6100	6000
R 34.0 x 20.5 x 12.5	R 1.339 x 0.807 x 0.492	X	5460	4300	6400	5000			7600	6000
R 36.0 x 23.0 x 15.0	R 1.417 x 0.906 x 0.591	X	5750	4300	6700	5000			8000	6000
R 38.1 x 19.05 x 12.7	R 1.500 x 0.750 x 0.500	X	7570	4300	8800	5000			10500	6000
R 40.0 x 24.0 x 16.0	R 1.575 x 0.945 x 0.630	X	7000	4300	8200	5000			9800	6000
R 41.8 x 26.2 x 12.5	R 1.646 x 1.031 x 0.492	X	5000	4300	5800	5000			7000	6000
R 50.0 x 30.0 x 20.0	R 1.969 x 1.181 x 0.787	X	8700	4300	10000	4900			12000	6000
R 58.3 x 40.8 x 17.6	R 2.283 x 1.606 x 0.693	X	5400	4300	6250	5000			7160	5700
R 63.0 x 38.0 x 25.0	R 2.480 x 1.496 x 0.984	X	10800	4300	12600	5000			13900	5500
R 68.0 x 48.0 x 13.0	R 2.677 x 1.890 x 0.512		3890	4300	4500	5000			5000	5500
R 87.0 x 54.3 x 13.5	R 3.425 x 2.138 x 0.531	X	5400	4300					7000	5500
R 102 x 65.8 x 15.0	R 4.016 x 2.591 x 0.591		5500	4200						
R 140 x 103 x 25.0	R 5.512 x 4.055 x 0.984		6200	4000						
R 202 x 153 x 25.0	R 7.953 x 6.024 x 0.984		5200	3700						
A _L -Wert-Toleranz Tolerance of A _L value			±25%		±30%		±25%		±25%	

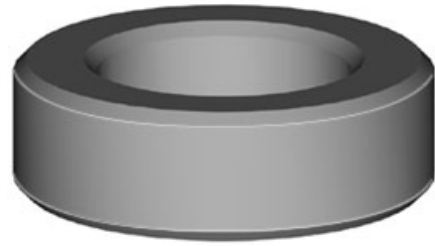
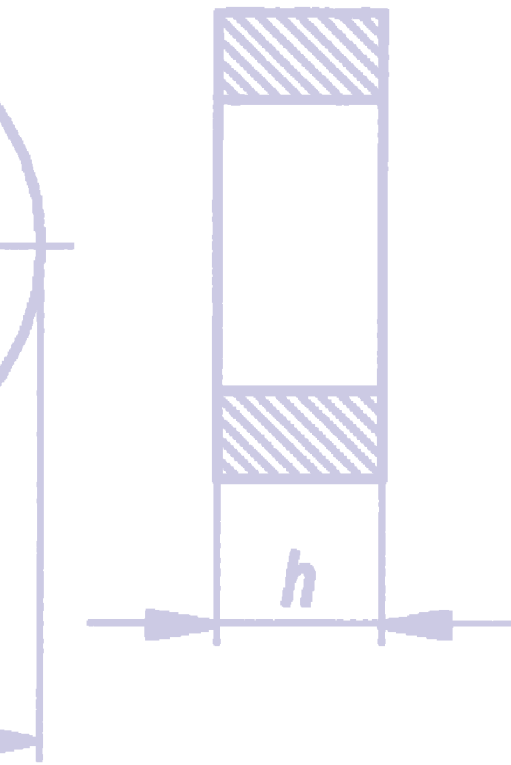

Angepresste Phase Chamfer

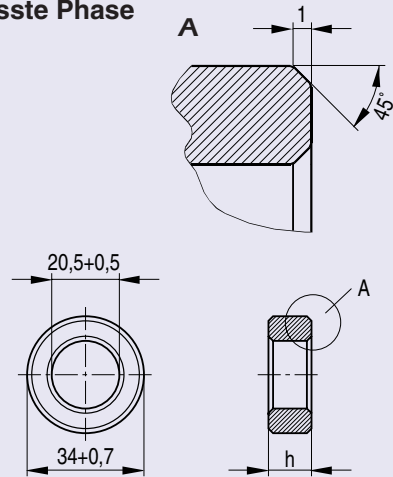

FUS0125-L

		Bestellnummer ¹⁾ Ordering code ¹⁾		
T38 (X038)		Block1	Block2	Block3
A _L	μ _i			
7900	10000	B64290	L0626	X***
10700	10000	B64290	L0618	X***
21300	10000	B64290	L0616	X***
13100	10000	B64290	L0647	X***
10600	10000	B64290	L0657	X***
10100	10000	B64290	L0058	X***
12700	10000	B64290	L0048	X***
13500	10000	B64290	L0674	X***
17600	10000	B64290	L0668	X***
		B64290	L0659	X***
		B64290	L0022	X***
		B64290	L0082	X***
		B64290	L0040	X***
		B64290	L0699	X***
		B64290	L0696	X***
		B64290	L0730	X***
		B64290	L0084	X***
		B64290	A0705	X***
		B64290	A0711	X***
±30%				

1) *** Kennziffer für Werkstoff (z. B. N30 = 830, T65 = 065)
Code number for material (e. g. N30 = 830, T65 = 065)

Magnetische Formkenngrößen Magnetic characteristics

Σl/A mm ⁻¹	l _e mm	A _e mm ²	V _e mm ³
1.59	56.82	35.78	2033
1.17	60.07	51.26	3079
0.59	60.07	102.5	6157
0.96	73.78	76.98	5680
1.19	77.02	64.66	4980
1.24	82.06	66.08	5423
0.99	82.06	82.60	6778
0.94	89.65	95.89	8597
0.71	82.97	116.2	9644
0.77	96.29	125.3	12070
1.08	103.0	95.75	9862
0.62	120.4	195.7	23560
1.00	152.4	152.4	23230
0.50	152.1	305.9	46530
1.39	178.6	128.7	22980
0.99	213.9	216.7	46360
0.96	255.3	267.2	68220
0.82	375.8	458.9	172440
0.90	550.5	608.6	335030

Toroids Ringkerne

Typ Type Größe / Size in mm	Abmessungen Dimensions		
	$d_a^{(1)}$ (mm)	$d_i^{(1)}$ (mm)	$h^{(1)}$ (mm)
R 2.50 x 1.50 x 1.00	2.50 ±0.12	1.50 ±0.1	1.00 ±0.1
R 2.54 x 1.27 x 1.27	2.54 ±0.12	1.27 ±0.12	1.27 ±0.12
R 3.05 x 1.27 x 1.27	3.05 ±0.12	1.27 ±0.12	1.27 ±0.12
R 3.05 x 1.27 x 2.54	3.05 ±0.12	1.27 ±0.12	2.54 ±0.12
R 3.05 x 1.78 x 2.03	3.05 ±0.12	1.78 ±0.12	2.03 ±0.12
R 3.43 x 1.78 x 1.78	3.43 ±0.12	1.78 ±0.12	1.78 ±0.12
R 3.43 x 1.78 x 2.03	3.43 ±0.12	1.78 ±0.12	2.03 ±0.12
R 3.43 x 1.78 x 2.11	3.43 ±0.12	1.78 ±0.12	2.11 ±0.12
R 3.94 x 1.78 x 1.78	3.94 ±0.12	1.78 ±0.12	1.78 ±0.12
R 3.94 x 2.24 x 1.30	3.94 ±0.12	2.24 ±0.12	1.30 ±0.12
R 4.00 x 2.40 x 1.60	4.00 ±0.12	2.40 ±0.12	1.60 ±0.1
R 5.84 x 3.05 x 3.00	5.84 ±0.12	3.05 ±0.12	3.00 ±0.12
R 6.30 x 3.80 x 2.50	6.30 ±0.15	3.80 ±0.12	2.50 ±0.12
R 9.53 x 4.75 x 3.17	9.53 ±0.19 (10.5 max)	4.75 ±0.12 (3.8 min)	3.17 ±0.15 (4.1 max)
R 10.0 x 6.00 x 4.00	10.0 ±0.2 (10.8 max)	6.0 ±0.15 (5.25 min)	4.00 ±0.15 (4.75 max)
R 12.5 x 7.50 x 5.00	12.5 ±0.3 (13.6 max)	7.5 ±0.2 (6.5 min)	5.00 ±0.15 (5.95 max)
R 12.7 x 7.90 x 6.35	12.7 ±0.3 (13.6 max)	7.9 ±0.25 (7.15 min)	6.35 ±0.2 (7.15 max)
R 13.3 x 8.30 x 5.00	13.3 ±0.3 (14.4 max)	8.3 ±0.3 (7.2 min)	5.00 ±0.15 (5.95 max)
R 14.0 x 9.00 x 5.00	14.0 ±0.3 (15.1 max)	9.0 ±0.25 (7.95 min)	5.00 ±0.2 (6.0 max)
R 15.0 x 10.4 x 5.30	15.0 ±0.5 (16.3 max)	10.4 ±0.4 (9.2 min)	5.30 ±0.3 (6.4 max)
R 15.8 x 8.90 x 4.70	15.8 ±0.38 (16.8 max)	8.9 ±0.25 (8.05 min)	4.70 ±0.13 (5.45 max)
R 16.0 x 9.60 x 6.30	16.0 ±0.4 (17.2 max)	9.6 ±0.3 (8.5 min)	6.30 ±0.2 (7.3 max)
R 17.0 x 10.7 x 6.80	17.0 ±0.4 (18.2 max)	10.7 ±0.3 (9.6 min)	6.80 ±0.2 (7.8 max)
R 18.4 x 5.90 x 5.90	18.4 ±0.4 (19.5 max)	5.9 ±0.3 (4.8 min)	5.90 ±0.2 (6.7 max)
R 20.0 x 10.0 x 7.00	20.0 ±0.4 (21.2 max)	10.0 ±0.25 (8.75 min)	7.00 ±0.4 (8.1 max)
R 22.1 x 13.7 x 6.35	22.1 ±0.4 (23.3 max)	13.7 ±0.3 (12.6 min)	6.35 ±0.3 (7.4 max)
R 22.1 x 13.7 x 7.90	22.1 ±0.4 (23.3 max)	13.7 ±0.3 (12.6 min)	7.90 ±0.3 (9.0 max)
R 22.1 x 13.7 x 12.5	22.1 ±0.4 (23.3 max)	13.7 ±0.3 (12.6 min)	12.5 ±0.5 (13.8 max)
R 22.6 x 14.7 x 9.20	22.6 ±0.4 (23.8 max)	14.7 ±0.2 (13.7 min)	9.20 ±0.2 (10.2 max)
R 25.3 x 14.8 x 10.0	25.3 ±0.7 (26.8 max)	14.8 ±0.5 (13.5 min)	10.0 ±0.2 (11.0 max)
R 25.3 x 14.8 x 20.0	25.3 ±0.7 (26.8 max)	14.8 ±0.5 (13.5 min)	20.0 ±0.5 (21.3 max)
R 29.5 x 19.0 x 14.9	29.5 ±0.7 (31.0 max)	19.0 ±0.5 (17.7 min)	14.9 ±0.4 (16.1 max)
R 30.5 x 20.0 x 12.5	30.5 ±1.0 (32.3 max)	20.0 ±0.6 (18.2 min)	12.5 ±0.4 (13.7 max)
R 34.0 x 20.5 x 10.0	34.0 ±0.7 (35.5 max)	20.5 ±0.5 (19.2 min)	10.0 ±0.3 (11.1 max)
R 34.0 x 20.5 x 12.5	34.0 ±0.7 (35.5 max)	20.5 ±0.5 (19.2 min)	12.5 ±0.3 (13.6 max)
R 36.0 x 23.0 x 15.0	36.0 ±0.7 (37.5 max)	23.0 ±0.5 (21.7 min)	15.0 ±0.4 (16.2 max)
R 38.1 x 19.05 x 12.7	38.1 ±0.5 (39.2 max)	19.05 ±0.4 (18.05 min)	12.7 ±0.3 (13.6 max)
R 40.0 x 24.0 x 16.0	40.0 ±1.0 (41.8 max)	24.0 ±0.7 (22.5 min)	16.0 ±0.4 (17.2 max)
R 41.8 x 26.2 x 12.5	41.8 ±1.0 (43.6 max)	26.2 ±0.6 (24.8 min)	12.5 ±0.3 (13.6 max)
R 50.0 x 30.0 x 20.0	50.0 ±1.0 (51.8 max)	30.0 ±0.7 (28.5 min)	20.0 ±0.5 (21.3 max)
R 58.3 x 40.8 x 17.6	58.3 ±1.0 (60.1 max)	40.8 ±0.8 (39.2 min)	17.6 ±0.4 (18.8 max)
R 63.0 x 38.0 x 25.0	63.0 ±1.5 (65.3 max)	38.0 ±1.2 (36.0 min)	25.0 ±0.8 (26.6 max)
R 68.0 x 48.0 x 13.0	68.0 ±1.2 (60.1 max)	48.0 ±1.0 (46.2 min)	13.0 ±0.4 (14.2 max)
R 87.0 x 54.3 x 13.5	87.0 ±1.5 (89.3 max)	54.3 ±1.1 (52.4 min)	13.5 ±0.3 (14.8 max)
R 102 x 65.8 x 15.0	102.0 ±2.0 (104.8 max)	65.8 ±1.3 (63.7 min)	15.0 ±0.5 (16.3 max)
R 140 x 103 x 25.0	140.0 ±3.0 (143.8 max)	103.0 ±2.0 (100.2 min)	25.0 ±1.0 (26.8 max)
R 202 x 153 x 25.0	202.0 ±4.0 (206.8 max)	153.0 ±3.0 (149.2 min)	25.0 ±1.0 (26.8 max)

1) Werte in Klammern für beschichtete Kerne. Bei Ringkernen aus NiZn-Ferrit können Maßüberschreitungen von bis zu 5% auftreten.
Values in parentheses apply to coated cores, toroids made of NiZn ferrite may exceed the specified dimensions by up to 5%.

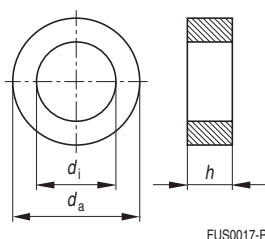

Typ Type Größe / Size in inch	Abmessungen Dimensions		
	$d_a^{1)}$ (inch)	$d_i^{1)}$ (inch)	$h^{1)}$ (inch)
R0.098x0.059x0.039	0.098 ±0.005	0.059 ±0.004	0.039 ±0.004
R0.100x0.050x0.050	0.100 ±0.005	0.050 ±0.005	0.050 ±0.005
R0.120x0.050x0.050	0.120 ±0.005	0.050 ±0.005	0.050 ±0.005
R0.120x0.050x0.100	0.120 ±0.005	0.050 ±0.005	0.100 ±0.005
R0.120x0.070x0.080	0.120 ±0.005	0.070 ±0.005	0.080 ±0.005
R0.135x0.070x0.070	0.135 ±0.005	0.070 ±0.005	0.070 ±0.005
R0.135x0.070x0.080	0.135 ±0.005	0.070 ±0.005	0.080 ±0.005
R0.135x0.070x0.083	0.135 ±0.005	0.070 ±0.005	0.083 ±0.005
R0.155x0.070x0.070	0.155 ±0.005	0.070 ±0.005	0.070 ±0.005
R0.155x0.088x0.051	0.155 ±0.005	0.088 ±0.005	0.051 ±0.005
R0.157x0.094x0.063	0.157 ±0.005	0.094 ±0.005	0.063 ±0.004
R0.230x0.120x0.118	0.230 ±0.005	0.120 ±0.005	0.118 ±0.005
R0.248x0.150x0.098	0.248 ±0.006	0.150 ±0.005	0.098 ±0.005
R0.375x0.187x0.125	0.375 ±0.007 (0.413 max)	0.187 ±0.005 (0.130 min)	0.125 ±0.006 (0.161 max)
R0.394x0.236x0.157	0.394 ±0.008 (0.433 max)	0.236 ±0.006 (0.199 min)	0.157 ±0.006 (0.195 max)
R0.492x0.295x0.197	0.492 ±0.012 (0.535 max)	0.295 ±0.008 (0.256 min)	0.197 ±0.005 (0.234 max)
R0.500x0.311x0.250	0.500 ±0.012 (0.535 max)	0.311 ±0.010 (0.281 min)	0.250 ±0.008 (0.281 max)
R0.524x0.327x0.197	0.524 ±0.012 (0.567 max)	0.327 ±0.012 (0.283 min)	0.197 ±0.005 (0.234 max)
R0.551x0.354x0.197	0.551 ±0.012 (0.594 max)	0.354 ±0.012 (0.313 min)	0.197 ±0.008 (0.236 max)
R0.591x0.409x0.209	0.591 ±0.020 (0.642 max)	0.409 ±0.016 (0.362 min)	0.209 ±0.012 (0.252 max)
R0.622x0.350x0.185	0.622 ±0.015 (0.661 max)	0.350 ±0.010 (0.317 min)	0.185 ±0.005 (0.215 max)
R0.630x0.378x0.248	0.630 ±0.016 (0.677 max)	0.378 ±0.012 (0.335 min)	0.248 ±0.008 (0.287 max)
R0.669x0.421x0.268	0.669 ±0.016 (0.717 max)	0.421 ±0.012 (0.378 min)	0.268 ±0.008 (0.307 max)
R0.724x0.232x0.232	0.724 ±0.016 (0.768 max)	0.232 ±0.012 (0.189 min)	0.232 ±0.008 (0.264 max)
R0.787x0.394x0.276	0.787 ±0.016 (0.835 max)	0.394 ±0.010 (0.344 min)	0.276 ±0.016 (0.319 max)
R0.870x0.539x0.250	0.870 ±0.016 (0.917 max)	0.539 ±0.012 (0.496 min)	0.250 ±0.012 (0.291 max)
R0.870x0.539x0.311	0.870 ±0.016 (0.917 max)	0.539 ±0.012 (0.496 min)	0.311 ±0.012 (0.354 max)
R0.870x0.539x0.492	0.870 ±0.016 (0.917 max)	0.539 ±0.012 (0.496 min)	0.492 ±0.020 (0.543 max)
R0.890x0.579x0.362	0.890 ±0.016 (0.937 max)	0.579 ±0.008 (0.539 min)	0.362 ±0.008 (0.402 max)
R0.996x0.583x0.394	0.996 ±0.028 (1.043 max)	0.583 ±0.020 (0.531 min)	0.394 ±0.008 (0.433 max)
R0.996x0.583x0.787	0.996 ±0.028 (1.043 max)	0.583 ±0.020 (0.531 min)	0.787 ±0.020 (0.839 max)
R1.142x0.748x0.587	1.142 ±0.028 (1.220 max)	0.748 ±0.020 (0.697 min)	0.587 ±0.016 (0.634 max)
R1.201x0.787x0.492	1.201 ±0.039 (1.272 max)	0.787 ±0.024 (0.717 min)	0.492 ±0.016 (0.539 max)
R1.339x0.807x0.394	1.339 ±0.028 (1.398 max)	0.807 ±0.020 (0.756 min)	0.394 ±0.012 (0.437 max)
R1.339x0.807x0.492	1.339 ±0.028 (1.398 max)	0.807 ±0.020 (0.756 min)	0.492 ±0.012 (0.535 max)
R1.417x0.906x0.591	1.417 ±0.028 (1.476 max)	0.906 ±0.020 (0.854 min)	0.591 ±0.016 (0.638 max)
R1.500x0.750x0.500	1.500 ±0.020 (1.543 max)	0.750 ±0.016 (0.711 min)	0.500 ±0.012 (0.535 max)
R1.575x0.945x0.630	1.575 ±0.039 (1.646 max)	0.945 ±0.028 (0.886 min)	0.630 ±0.016 (0.677 max)
R1.646x1.031x0.492	1.646 ±0.039 (1.717 max)	1.031 ±0.024 (0.976 min)	0.492 ±0.012 (0.535 max)
R1.969x1.181x0.787	1.969 ±0.039 (2.039 max)	1.181 ±0.028 (1.122 min)	0.787 ±0.020 (0.839 max)
R2.283x1.606x0.693	2.283 ±0.039 (2.366 max)	1.606 ±0.031 (1.543 min)	0.693 ±0.016 (0.740 max)
R2.480x1.496x0.984	2.480 ±0.059 (2.571 max)	1.496 ±0.047 (1.417 min)	0.984 ±0.031 (1.047 max)
R2.677x1.890x0.512	2.677 ±0.047 (2.756 max)	1.890 ±0.039 (1.819 min)	0.512 ±0.015 (0.559 max)
R3.425x2.138x0.531	3.425 ±0.059 (3.516 max)	2.138 ±0.043 (2.063 min)	0.531 ±0.012 (0.583 max)
R4.016x2.591x0.591	4.016 ±0.079 (4.126 max)	2.591 ±0.051 (2.508 min)	0.591 ±0.020 (0.642 max)
R5.512x4.055x0.984	5.512 ±0.118 (5.661 max)	4.055 ±0.079 (3.945 min)	0.984 ±0.039 (1.055 max)
R7.953x6.024x0.984	7.953 ±0.157 (8.142 max)	6.024 ±0.118 (5.874 min)	0.984 ±0.039 (1.055 max)

1) Werte in Klammern für beschichtete Kerne. Bei Ringkernen aus NiZn-Ferrit können Maßüberschreitungen von bis zu 5% auftreten.
Values in parentheses apply to coated cores, toroids made of NiZn ferrite may exceed the specified dimensions by up to 5%.

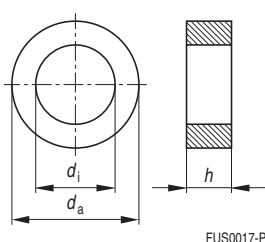

Symbols and Terms

Symbole und Begriffe

Symbol	Bezeichnung	Term	Einheit/Unit
A_e	Effektiver magnetischer Querschnitt	Effective magnetic cross section	mm ²
A_L	Induktivitätsfaktor: $A_L = L/N^2$	Inductance factor: $A_L = L/N^2$	nH
A_{min}	Min. Kernquerschnitt	Minimum core cross section	mm ²
\hat{B}	Scheitelwert der magnetischen Flussdichte	Peak value of magnetic flux density	Vs/m ² , mT
ΔB	Hub der Flussdichte	Flux density swing	Vs/m ² , mT
B_S	Sättigungsmagnetisierung	Saturation magnetization	Vs/m ² , mT
f	Frequenz	Frequency	Hz
f_{max}	Obere Grenzfrequenz	Upper frequency limit	Hz
g	Luftspalt	Air gap	mm
\hat{H}	Scheitelwert der magnetischen Feldstärke	Peak value of magnetic field strength	A/m
L	Induktivität	Inductance	H = Vs/A
L_{IDC}	Induktivität bei Gleichstromvormagnetisierung	Inductance with DC bias	H
l_e	Effektive magnetische Weglänge	Effective magnetic path length	mm
N	Windungszahl	Number of turns	
P_V	Bezogene Kernverlustleistung	Specific core losses	kW/m ³
Q	Gütefaktor ($Q = \omega L/R_S = 1/\tan \delta_L$)	Quality factor ($Q = \omega L/R_S = 1/\tan \delta_L$)	
R_S	Serien-Verlustwiderstand eines Kerns	Series loss resistance of a core	Ω
T	Temperatur	Temperature	°C
T_C	Curietemperatur	Curie temperature	°C
$\tan \delta$	Verlustfaktor	Loss factor	
$\tan \delta/\mu_i$	Bezogener Verlustfaktor des Werkstoffes bei $B \rightarrow 0$	Relative loss factor of material at $B \rightarrow 0$	
V_e	Effektives magnetisches Volumen	Effective magnetic volume	mm ³
η_B	Hysteresematerialkonstante	Hysteresis material constant	mT ⁻¹
μ_i	Relative Anfangspermeabilität	Relative initial permeability	mm ⁻¹
$\Sigma l/A$	Magnetischer Formfaktor	Magnetic form factor	mm ⁻¹
ω	Kreisfrequenz; $\omega = 2 \Pi f$	Angular frequency; $\omega = 2 \Pi f$	1/s

Maße in mm, soweit nicht anders angegeben

SMD Oberflächenmontierbares Bauelement

The commas used in numerical values denote decimal points.

All dimensions are given in mm, otherwise specified

SMD Surface-mount device

Important Notes

Wichtige Hinweise

The following applies to all products named in this publication:

1. Some parts of this publication contain **statements about the suitability of our products for certain areas of application**. These statements are based on our knowledge of typical requirements that are often placed on our products in the areas of application concerned. We nevertheless expressly point out **that such statements cannot be regarded as binding statements about the suitability of our products for a particular customer application**. As a rule, EPCOS is either unfamiliar with individual customer applications or less familiar with them than the customers themselves. For these reasons, it is always ultimately incumbent on the customer to check and decide whether an EPCOS product with the properties described in the product specification is suitable for use in a particular customer application.
2. We also point out that **in individual cases, a malfunction of passive electronic components or failure before the end of their usual service life cannot be completely ruled out in the current state of the art, even if they are operated as specified**. In customer applications requiring a very high level of operational safety and especially in customer applications in which the malfunction or failure of a passive electronic component could endanger human life or health (e.g. in accident prevention or life-saving systems), it must therefore be ensured by means of suitable design of the customer application or other action taken by the customer (e.g. installation of protective circuitry or redundancy) that no injury or damage is sustained by third parties in the event of malfunction or failure of a passive electronic component.

3. **The warnings, cautions and product-specific notes must be observed.**

4. In order to satisfy certain technical requirements, **some of the products described in this publication may contain substances subject to restrictions in certain jurisdictions (e.g. because they are classed as "hazardous")**. Useful information on this will be found in our Material Data Sheets on the Internet (www.epcos.com/material). Should you have any more detailed questions, please contact our sales offices.

5. We constantly strive to improve our products. Consequently, **the products described in this publication may change from time to time**. The same is true of the corresponding product specifications. Please check therefore to what extent product descriptions and specifications contained in this publication are still applicable before or when you place an order.

We also **reserve the right to discontinue production and delivery of products**. Consequently, we cannot guarantee that all products named in this publication will always be available.

6. Unless otherwise agreed in individual contracts, **all orders are subject to the current version of the "General Terms of Delivery for Products and Services in the Electrical Industry" published by the German Electrical and Electronics Industry Association (ZVEI)**.

7. The trade names EPCOS, EPCOS-Jones, Baoke, CeraDiode, CSSP, MLSC, PhaseCap, PhaseMod, SIFI, SIKOREL, SilverCap, SIMID, SIOV, SIP5D, SIP5K, UltraCap, WindCap are **trademarks registered or pending** in Europe and in other countries. Further information will be found on the Internet at www.epcos.com/trademarks.

Für alle in dieser Publikation genannten Produkte gilt:

1. Diese Publikation enthält an einigen Stellen **Aussagen über die Eignung unserer Produkte für bestimmte Anwendungsgebiete**. Diese Aussagen basieren auf unserer Kenntnis von typischen Anforderungen, die auf den genannten Anwendungsgebieten häufig an unsere Produkte gestellt werden. Wir weisen aber ausdrücklich darauf hin, **dass derartige Aussagen nicht als verbindliche Aussagen zur Eignung unserer Produkte für eine bestimmte Kundenanwendung zu werten sind**. In aller Regel kennt EPCOS die einzelne Kundenanwendung entweder nicht oder ist mit der Anwendung und ihren Anforderungen weniger vertraut als der Kunde selbst. Es obliegt deshalb letztlich immer dem Kunden, zu prüfen und zu entscheiden, ob ein EPCOS-Produkt mit seinen in der Produktspezifikation beschriebenen Eigenschaften für den Einsatz in der jeweiligen individuellen Kundenanwendung geeignet ist.
2. Außerdem weisen wir darauf hin, dass **nach dem derzeitigen Stand der Technik selbst bei spezifikationsgemäßem Betrieb in Einzelfällen eine Fehlfunktion passiver elektronischer Bauelemente oder ein Ausfall vor Ende ihrer üblichen Lebensdauer nicht vollständig auszuschließen ist**. Bei Kundenanwendungen, welche ein sehr hohes Maß an Betriebssicherheit erfordern und insbesondere bei Kundenanwendungen, bei denen eine Fehlfunktion oder ein Ausfall eines passiven elektronischen Bauelementes zu einer Gefährdung von Gesundheit oder Leben von Menschen führen könnte (z. B. unfallverhütende oder lebensschützende Systeme), muss deshalb durch geeignete Konstruktion der Kundenanwendung oder durch sonstige kundenseitige Maßnahmen (z. B. durch Einbau von Schutzschaltungen oder Redundanzen) dafür gesorgt werden, dass auch bei Fehlfunktion oder Ausfall eines passiven elektronischen Bauelementes keine Verletzung von Rechtsgütern Dritter eintritt.

3. **Die Warn- und Sicherheitshinweise sowie produktspezifischen Anmerkungen sind unbedingt zu beachten.**

4. Um bestimmten technischen Anforderungen gerecht zu werden, **können einige der in dieser Publikation aufgeführten Produkte Substanzen enthalten, die nach länderspezifischen Regelungen Restriktionen unterliegen (z. B. weil sie als „gefährlich“ eingestuft werden)**. Nützliche Informationen dazu enthalten unsere Materialdatenblätter im Internet (www.epcos.de/material). Bei weitergehenden Fragen wenden Sie sich bitte an unsere Vertriebsbüros.

5. Wir bemühen uns laufend, unsere Produkte zu verbessern. Infolge dessen **ändern sich die in dieser Publikation beschriebenen Produkte von Zeit zu Zeit**. Gleiches gilt auch für die entsprechenden Produktspezifikationen. Vergewissern Sie sich deshalb vor oder bei Ihrer Bestellung, inwieweit die in der vorliegenden Publikation angegebenen Produktbeschreibungen und Produktspezifikationen noch gelten.

Im übrigen **behalten wir uns vor, die Produktion und Lieferung von Produkten einzustellen**. Eine Gewähr für die dauerhafte Verfügbarkeit aller in dieser Publikation genannten Produkte können wir deshalb nicht übernehmen.

6. Außer in Fällen, in denen abweichende individualvertragliche Vereinbarungen getroffen werden, **gelten für Bestellungen die jeweils aktuell vom Zentralverband Elektrotechnik- und Elektronikindustrie e.V. (ZVEI) herausgegebenen „Allgemeinen Lieferbedingungen für Erzeugnisse und Leistungen der Elektroindustrie“**.

7. Die Bezeichnungen EPCOS, EPCOS-Jones, Baoke, CeraDiode, CSSP, MLSC, PhaseCap, PhaseMod, SIFI, SIKOREL, SilverCap, SIMID, SIOV, SIP5D, SIP5K, UltraCap, WindCap sind in Europa und in anderen Ländern **registrierte oder zum Schutz angemeldete Marken**. Weitere Informationen hierzu finden Sie im Internet unter www.epcos.de/trademarks.

EPCOS Worldwide

Europe/Europa

Austria/Österreich
Bulgaria/Bulgarien
Romania/Rumänien
Serbia & Montenegro/
Serbien & Montenegro

EPCOS CSEE
Siemensstr. 92
1210 Wien
☎ +43 51 70 72 56 30
FAX +43 51 70 75 56 30

Belgium/Belgien
Luxembourg/Luxemburg
Netherlands/Niederlande

Siemens N.V.
Agency for EPCOS
Building 23
Charleroisesteenweg 116
1060 Brussel
☎ +32 3 2 87 39 18
FAX +32 2 5 36 28 57

Czech Republic/
Tschechische Republik

EPCOS s.r.o.
Evropská 33a
160 00 Praha 6
☎ +420 2 33 03 22 81
FAX +420 2 33 03 22 89

Finland/Finland

EPCOS Nordic OY
P.O. Box 275
02601 Espoo
☎ +358 10 5 11 32 00
FAX +358 10 5 11 22 85

France/Frankreich

EPCOS SAS
"Les Borromées"
3, avenue du Stade de France
93210 Saint-Denis La Plaine Cedex
☎ +33 1 49 46 67 89
FAX +33 1 49 46 67 67

Germany/Deutschland

Switzerland/Schweiz
EPCOS AG
Vertrieb Deutschland, Schweiz
Postfach 801709
81617 München
Customer Service:
☎ (D) 0 180 5 00 33 48
(0,12 Euro/Min.)
(CH) 08 48 37 26 71
FAX +49 89 63 62 80 10

Great Britain/Großbritannien

Ireland/Irland
EPCOS UK Ltd.
Summit House
London Road
Bracknell
Berkshire
RG12 2AQ
☎ +44 13 44 38 15 10
FAX +44 13 44 38 15 12

Greece/Griechenland

AZEGO Hellas S.A.
7, Palama str.
15126 Marousi Athens
☎ +30 2 295 04 16 01
FAX +30 22 95 04 16 46

Hungary/Ungarn

EPCOS Kft. Értékesítési iroda
Sales Offices
Lajos utca 48 - 66.
1036 Budapest
☎ +36 1 436 07 27
FAX +36 1 436 07 21

Italy/Italien

Siemens S. p. A.
Settore EPCOS
Casella Postale 17154
Viale Piero e Alberto Pirelli, 10
20126 Milano
☎ +39 02 24 36 42 65
FAX +39 02 24 36 43 80

Poland/Polen

Siemens Sp. z.o.o.
ul. Zupnicza 11
P.O.B. 159
03-821 Warszawa
☎ +48 22 8 70 91 50
FAX +48 22 8 70 91 59

Portugal

EPCOS AG
R. Elias Garcia 249 3º B
2700-320 Amadora
☎ +351 91 75 67 927
FAX +351 21 4933 476

Russia/Russland

OOO Siemens
EPCOS Division
ul. Malaya Kaluzhskaya 19
119071 Moscow
☎ +7 495 7 37 24 17
+7 495 7 37 24 18
FAX +7 495 7 37 23 46

Slovakia/Slowakei

EPCOS Sales Representative
Hviezdoslavovo námestie 1688/15
026 01 Dolný Kubín
☎ +42 1 43 5 82 36 73
FAX +42 1 43 5 82 37 33

Slovenia/Slowenien

Bosnia and Herzegovina/
Bosnien Herzegovina
Croatia/Kroatien
EPCOS Sales Representative
Omersova 5
1000 Ljubljana
☎ +386 1 510 12 91
FAX +386 1 510 12 92

Spain/Spainien

Siemens S.A.
Division de Componentes
Ronda de Europa, 5
28760 Tres Cantos (Madrid)
☎ +34 91 5 14 80 00
FAX +34 91 5 14 70 14

Sweden/Schweden

Denmark/Dänemark

Norway/Norwegen

EPCOS Nordic AB
P.O. Box 46
16493 Kista
☎ +46 8 4 77 27 00
FAX +46 8 4 77 27 01

Turkey/Türkei

EPCOS AG Liaison Office Turkey
Sehit Mehmet Fatih Ongül Sok.
Bagdatlioglu Plaza No:3 Office:4
34742 Kozyatagi Istanbul
☎ +90 216 4 64 07 55
FAX +90 216 4 64 07 56

Africa/Afrika

Egypt/Ägypten

Siemens Ltd.
Automation & Drives (A&D)
55, El Nakhil and El Aenab St.
Mohandessin, Cairo
P.O. Box 775, 11511 Cairo
☎ +202 333 36 69
FAX +202 333 36 07

Republic of South Africa/
Südafrika

Electrocomp (PTY) Ltd.
Cnr. Galaxy Avenue & Electron
Street
Linbro Business Park
Sandton
P.O. Box 1023, Bramley 2018
☎ +27 11 458 90 00 32
FAX +27 11 458 90 34

America/Amerika

South America/Südamerika

EPCOS do Brasil Ltda.
Av. Ermano Marchetti 1435 - 4º
andar
Lapa – São Paulo – SP
05038-001 - Brazil
☎ +55 11 38 17 34 46
FAX +55 11 38 17 34 43

NAFTA

EPCOS, Inc.
186 Wood Avenue South
Selin, NJ 08830
☎ +1 732 9 06 43 00
FAX +1 732 6 32 28 30

USA

EPCOS, Inc.
Peabody Office Building
1 Newbury Street
Peabody, MA 01960-3830
☎ +1 978 5 35 55 52
FAX +1 978 5 35 62 25

EPCOS, Inc.
1607 Squaw Walden Lane
Apex, NC 27523
☎ +1 919 3 03 59 33
FAX +1 919 3 03 59 34

EPCOS, Inc.

3116 Val Vista Drive
P.O. Box 3724
Easton, PA 18043-3724
☎ +1 610 4 38 06 46
FAX +1 610 4 38 36 55

EPCOS, Inc.

12300 Ford Road
Suite 405
Dallas, TX 75234
☎ +1 972 4 81 88 18
FAX +1 972 4 81 88 58

EPCOS, Inc.

11770 Bernardo Plaza Court,
Suite 101
San Diego, CA 92128
☎ +1 858 6 76 36 88
FAX +1 858 6 76 36 87

EPCOS, Inc.

110 Peyton Road
Huntsville, AL 35748
☎ +1 256 7 76 95 23
FAX +1 256 7 76 95 24

EPCOS, Inc.

118 Governor's Square
Fayetteville, GA 30215
☎ +1 770 6 31 12 60
FAX +1 770 6 31 28 60

EPCOS, Inc.

5700 Lake Worth Road
Suite 209-5
Lake Worth, FL 33463
☎ +1 561 9 65 15 44
FAX +1 561 9 65 15 43

EPCOS, Inc.

1400 East Touhy Avenue, Suite
430
Des Plaines, IL 60018
☎ +1 847 299 7220
FAX +1 847 299 7240

EPCOS, Inc.

301 Prospect Street
Newport Beach, CA 92663
☎ +1 949 548 1242
FAX +1 949 548 1712

EPCOS, Inc.

21540 Shore Vista Lane
Noblesville, IN 46060
☎ +1 317 9 84 54 05
FAX +1 732 8 75 07 82

Crystal Technology, Inc.

An EPCOS Company
1040 East Meadow Circle
Palo Alto, CA 94303-4230
☎ +1 650 8 56 79 11
FAX +1 650 3 54 01 73

Asia/Asien

PR China/VR China

Baoke Electronic
(Wuxi) Co Ltd
1058 Jianzhu Road
Liyuan Economic Development
Zone
Wuxi 214072, Jiangsu
☎ +86 51 02 24 28 01
FAX +86 51 02 24 28 03

EPCOS (Shanghai) Ltd.

Beijing Office
Room 2203, No. 24A
East Ocean Centre
Jian Guo Men Wai Street
Chao Yang District
Beijing 100004
☎ +86 10 65 15 78 54
FAX +86 10 65 15 59 19

EPCOS (Shanghai) Ltd.

Shanghai Office
Room 633 - 641, 6/F, Shanghai
Central Plaza
No. 381 Huai Hai Zhong Road
Shanghai, 200020
☎ +86 21 63 91 68 90
FAX +86 21 63 91 68 89

EPCOS (Shanghai) Ltd.

Shenzhen Office
Room 402, 4/F., Hantang Building
Overseas Chinese Town, Shenzhen
Guangdong Province, P.R. China
ZIP Code: 518053
☎ +86 7 55 26 93 57 58
FAX +86 7 55 26 93 57 57

EPCOS (Xiaogan) Co., Ltd

257-1, Changzheng Road
Xiaogan 432104, Hubei
☎ +86 7 12 285 35 39
FAX +86 7 12 285 87 34

EPCOS Ltd.

Suite 1208-11, 12/F
World Finance Centre
North Tower, Harbour City
Tsim Sha Tsui
Kowloon, Hong Kong
☎ +85 2 31 01 56 00
FAX +85 2 31 01 56 46

India/Indien

EPCOS India Private Ltd.
Sales
14/2, Brunton Road
Bangalore 560 025
☎ +91 80 25 55 96 40
+91 80 25 55 96 50
FAX +91 80 25 55 96 45

Israel

Nisko Projects
Electronics & Communications
(1999) Ltd.
2a, Habarzel Street
Tel Aviv 69710
☎ +972 37 65 73 00
FAX +972 37 65 73 33

Japan

EPCOS KK
Shin-Yokohama Square Building
11F
2-3-12 Shin-Yokohama, Kohoku-ku
Yokohama, Kanagawa 222-0033
☎ +81 45 4 78 72 00
FAX +81 45 4 78 72 25

EPCOS KK

Hankyu Terminal Building 9F,
1-1-4 Shibata, Kita-ku
Osaka, Osaka 530-0012
☎ +81 6 62 92 69 11
FAX +81 6 62 92 69 15

Korea

Siemens Ltd.
Epcos Division
11 th floor, PMK Bldg.
746 Yeoksam-dong,
Gangnam-gu,
Seoul 135-080, Korea
☎ +82 2 34 50 75 81
FAX +82 2 34 50 75 98

Malaysia

EPCOS SDN. BHD.
Kuala Lumpur Sales Office
Suite 11,01A Menara Merais
No. 1 Jalan 19/3
46300 Petaling Jaya
Selangor
☎ +60 3 79 60 81 80
FAX +60 3 79 60 81 82

Philippines/Philippinen

Siemens Inc.
EPCOS Department
12/F Floor Salcedo Tower B
169 H.V. De La Costa St.
Salcedo Village
Makati City 1227, Manila
☎ +63 2 8 78 94 41
FAX +63 2 8 78 94 40

Singapore/Singapur

EPCOS PTE LTD
166 Kallang Way
Singapore 349249
☎ +65 68 41 20 11
FAX +65 67 44 69 92

Taiwan

EPCOS Taiwan Co. Ltd.
4F-1, No.3-1 Yuan Qu Street
Nankang Dist. Taipei 115
☎ +886 2 26 55 76 76
FAX +886 2 55 59 02 88

Australia/Australien

Australia/Australien

Siemens Ltd.
Components Division
Head Office
885 Mountain Highway
Bayswater, VIC 3153
☎ +61 3 97 21 70 39
FAX +61 3 97 21 72 75

For an up to date overview of our
worldwide distribution network
please refer to our website at
www.epcos.com/sales

Die Adressen unserer Distributoren
finden Sie im Internet unter
www.epcos.de/sales

Published by EPCOS AG, Corporate Center
P.O.B. 80 17 09, 81617 Munich, GERMANY
☎ +49 89 636-09, FAX +49 89 636-2 26 89

© EPCOS AG 2006. Reproduction, publication and dissemination of this publication and the
information contained therein without EPCOS' prior express consent is prohibited.

Herausgegeben von EPCOS AG, Corporate Center
Postfach 80 17 09, 81617 München, DEUTSCHLAND
☎ +49 89 636-09, FAX +49 89 636-2 26 89

© EPCOS AG 2006. Vervielfältigung, Veröffentlichung, Verbreitung und Verwertung dieser
Publikation und ihres Inhalts ohne ausdrückliche Genehmigung der EPCOS AG nicht
gestattet.