

## Power Schottky rectifier in flat package

Datasheet - production data

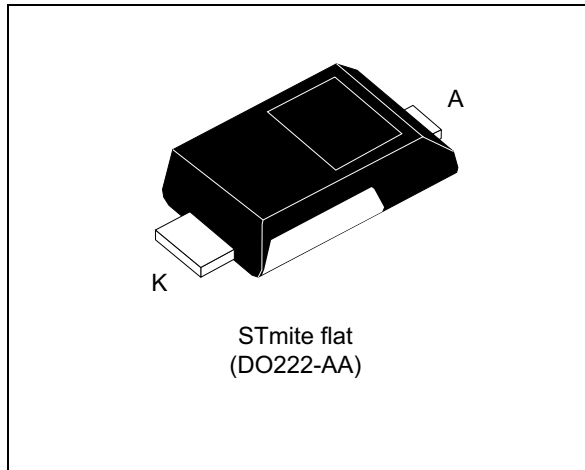

### Features

- Very low profile package: 0.85 mm
- Backward compatible with standard STmite footprint
- Very small conduction losses
- Negligible switching losses
- Extremely fast switching
- Low forward voltage drop for higher efficiency and extended battery life
- Low thermal resistance
- Avalanche capability specified
- Halogen free molding compound

### Description

Single Schottky rectifier suited for switch mode power supplies and high frequency DC to DC converters.

Packaged in STmite flat, this device is intended for use in low voltage, high frequency inverters, free wheeling and polarity protection applications.

Due to the very small size of the package this device fits battery powered equipment (cellular, notebook, PDA's, printers) as well as chargers and PCMCIA cards.

**Table 1. Device summary**

Symbol	Value
$I_{F(AV)}$	1 A
$V_{RRM}$	20 V
$T_j$ (max)	150 °C
$V_F$ (typ)	0.36 V

# 1 Characteristics

**Table 2. Absolute ratings (limiting values at T<sub>amb</sub> = 25 °C, unless otherwise specified)**

Symbol	Parameter	Value	Unit	
V <sub>R</sub> RM	Repetitive peak reverse voltage	20	V	
I <sub>F</sub> (RMS)	Forward rms current	2	A	
I <sub>F</sub> (AV)	Average forward current, δ = 0.5, square wave	T <sub>c</sub> = 140 °C	1	A
I <sub>F</sub> SM	Surge non repetitive forward current	t <sub>p</sub> = 10 ms sinusoidal	50	A
P <sub>ARM</sub> <sup>(1)</sup>	Repetitive peak avalanche power	T <sub>j</sub> = 125 °C, t <sub>p</sub> = 10 μs	100	W
T <sub>stg</sub>	Storage temperature range	-65 to +150	°C	
T <sub>j</sub>	Maximum operating junction temperature <sup>(2)</sup>	150	°C	

- For pulse time duration deratings, please refer to [Figure 3](#). More details regarding the avalanche energy measurements and diode validation in the avalanche are provided in the STMicroelectronics Application notes AN1768, "Admissible avalanche power of Schottky diodes" and AN2025, "Converter improvement using Schottky rectifier avalanche specification".
- $\frac{dP_{tot}}{dT_j} < \frac{1}{R_{th(j-a)}}$  condition to avoid thermal runaway for a diode on its own heatsink

**Table 3. Thermal resistance**

Symbol	Parameter	Value	Unit
R <sub>th(j-c)</sub>	Junction to case	20	°C/W
R <sub>th(j-a)</sub> <sup>(1)</sup>	Junction to ambient	250	°C/W

- Mounted with minimum recommended pad size, PC board FR4.

**Table 4. Static electrical characteristics**

Symbol	Parameter	Test conditions	Min.	Typ.	Max.	Unit	
I <sub>R</sub> <sup>(1)</sup>	Reverse leakage current	T <sub>j</sub> = 25 °C	V <sub>R</sub> = V <sub>R</sub> RM	-	1.3	3.9	μA
		T <sub>j</sub> = 100 °C		-	275	850	
		T <sub>j</sub> = 25 °C	V <sub>R</sub> = 10 V	-	0.6	2.0	
		T <sub>j</sub> = 100 °C		-	145	450	
		T <sub>j</sub> = 25 °C	V <sub>R</sub> = 5 V	-	0.4	1.0	
		T <sub>j</sub> = 100 °C		-	105	300	
V <sub>F</sub> <sup>(2)</sup>	Forward voltage drop	T <sub>j</sub> = 25 °C	I <sub>F</sub> = 1 A	-	0.44	0.49	V
		T <sub>j</sub> = 100 °C		-	0.36	0.41	
		T <sub>j</sub> = 25 °C	I <sub>F</sub> = 2 A	-	0.48	0.54	
		T <sub>j</sub> = 100 °C		-	0.42	0.48	

- Pulse test: t<sub>p</sub> = 380 μs, δ < 2%
- Pulse test: t<sub>p</sub> = 380 μs, δ < 2%

To evaluate the conduction losses use the following equation:

$$P = 0.34 \times I_{F(AV)} + 0.07 \times I_{F(RMS)}^2$$

**Figure 1. Average forward power dissipation versus average forward current**

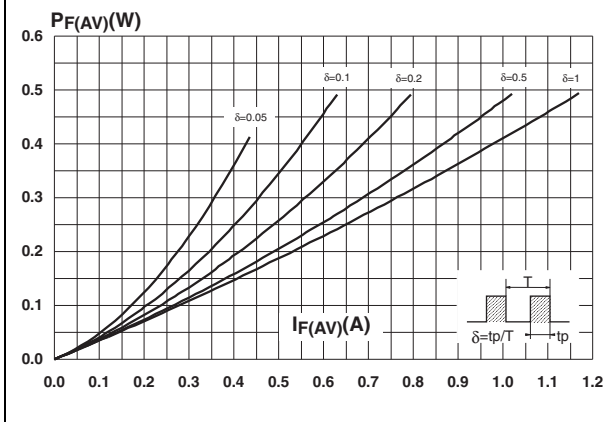

**Figure 2. Average forward current versus ambient temperature ( $\delta = 0.5$ )**

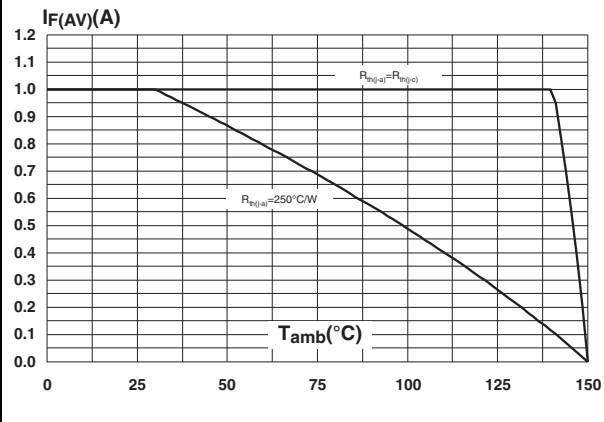

**Figure 3. Normalized avalanche power derating versus pulse duration ( $T_j = 125^\circ\text{C}$ )**

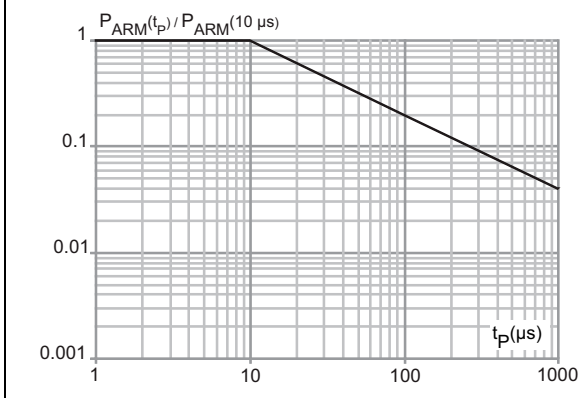

**Figure 4. Relative variation of thermal impedance junction to ambient versus pulse duration**

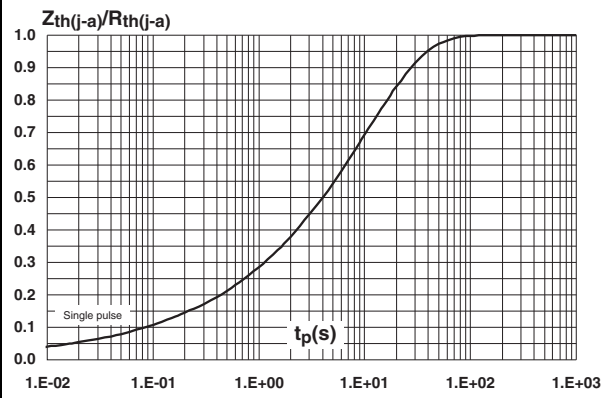

**Figure 5. Reverse leakage current versus reverse voltage applied (typical values)**

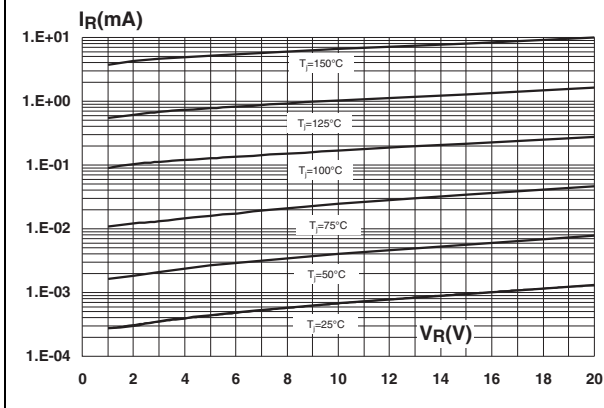

**Figure 6. Junction capacitance versus reverse voltage applied (typical values)**

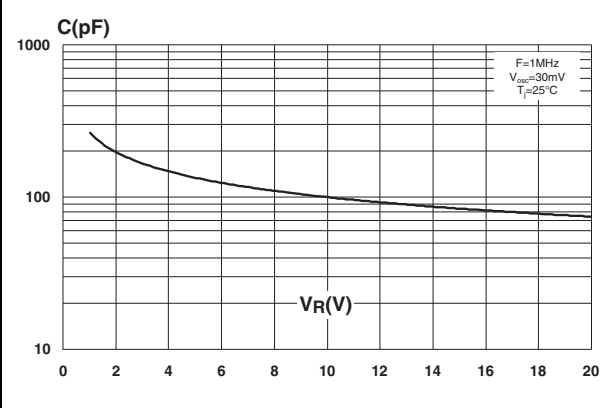

**Figure 7. Forward voltage drop versus forward current (low level)**

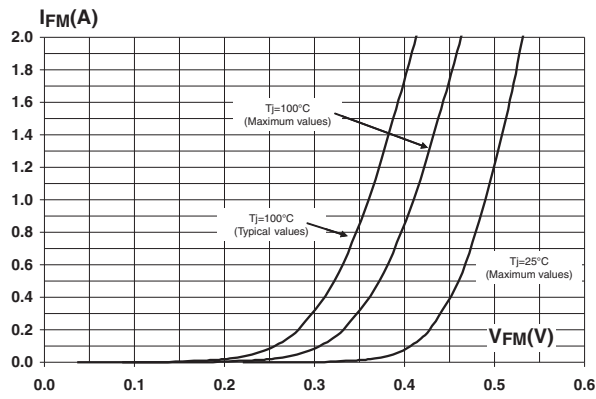

**Figure 8. Forward voltage drop versus forward current (high level)**

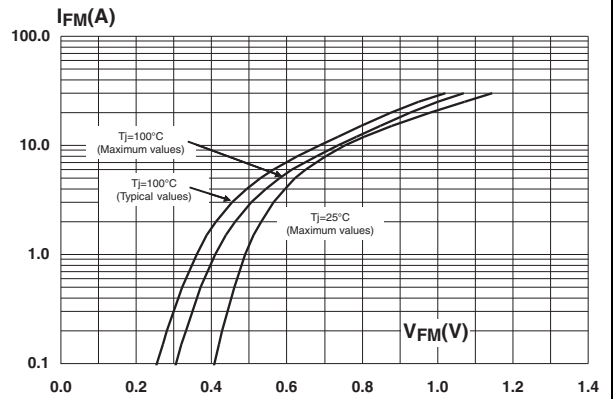

**Figure 9. Thermal resistance junction to ambient versus copper surface under tab (typical values)**

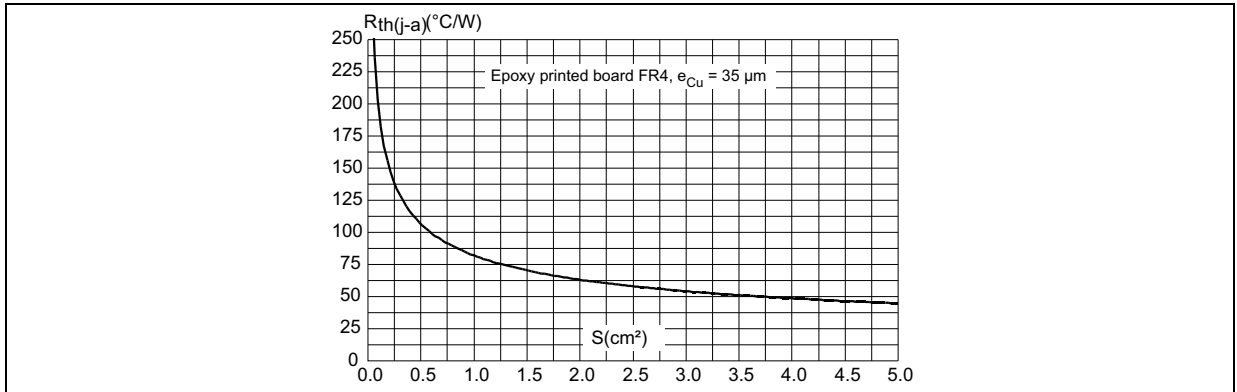

## 2 Package information

- Epoxy meets UL94, V0

In order to meet environmental requirements, ST offers these devices in different grades of ECOPACK<sup>®</sup> packages, depending on their level of environmental compliance. ECOPACK<sup>®</sup> specifications, grade definitions and product status are available at: [www.st.com](http://www.st.com). ECOPACK<sup>®</sup> is an ST trademark.

### 2.1 STmite flat package information

Figure 10. STmite flat package outline

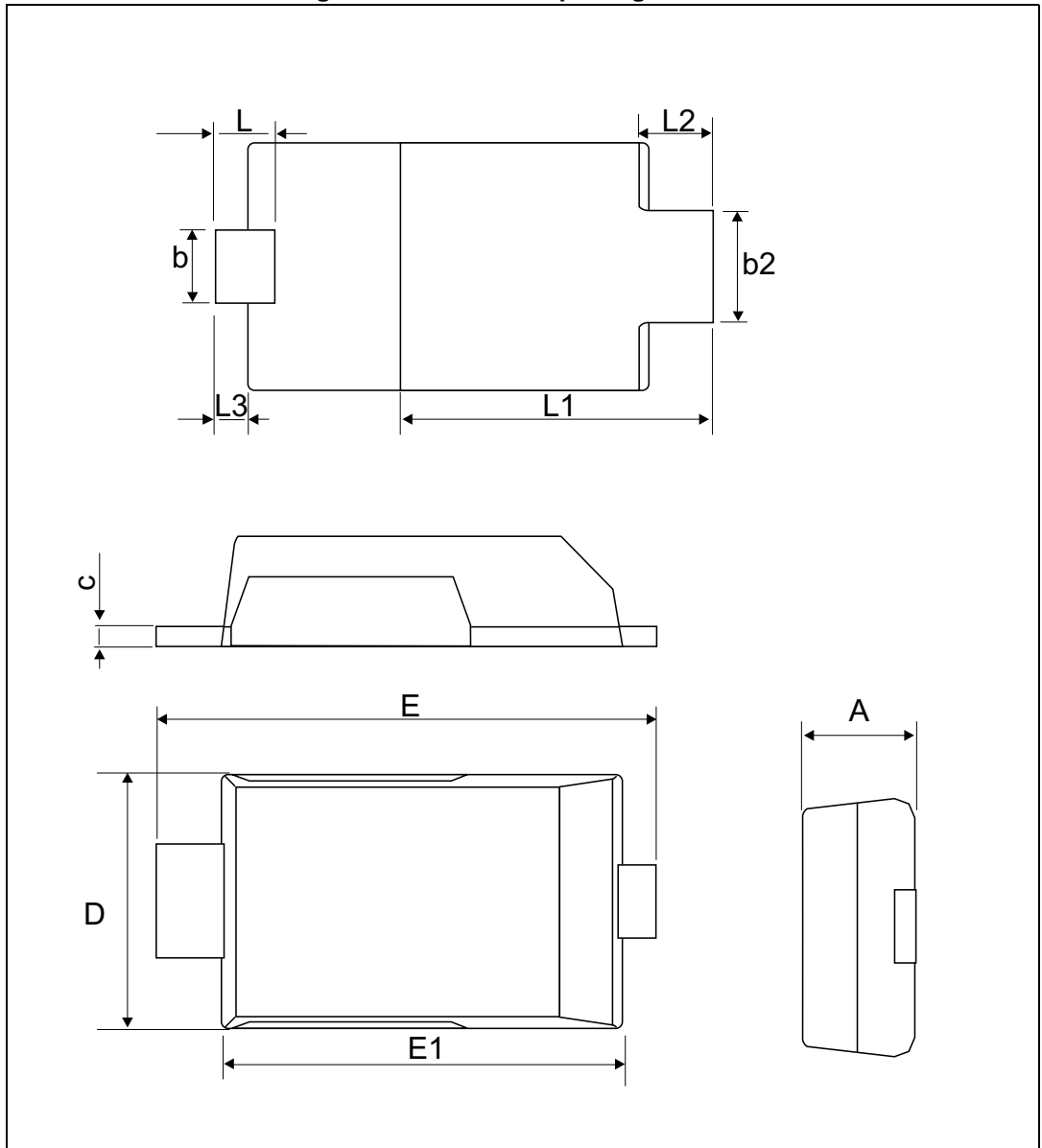
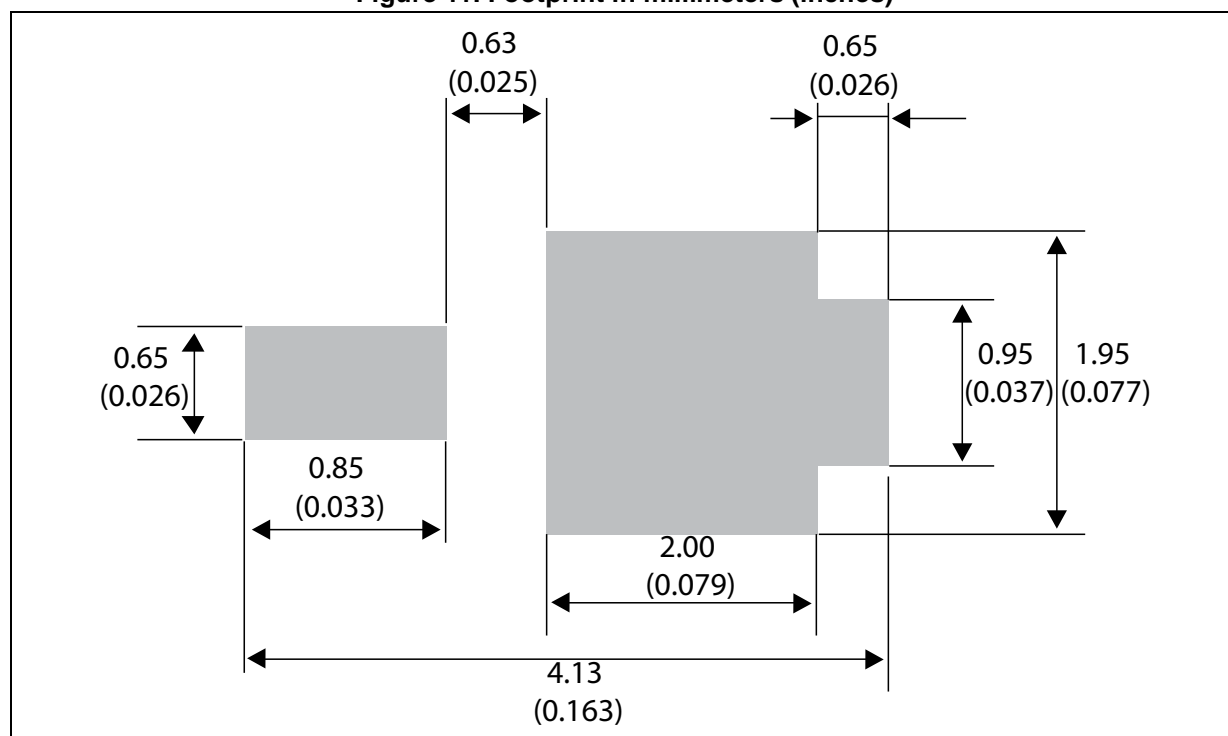

Table 5. STmite flat package mechanical data

Ref.	Dimensions					
	Millimeters			Inches		
	Min.	Typ.	Max.	Min.	Typ.	Max.
A	0.80	0.85	0.95	0.031	0.033	0.037
b	0.40	0.55	0.65	0.016	0.022	0.026
b2	0.70	0.85	1.00	0.027	0.033	0.039
c	0.10	0.15	0.25	0.004	0.006	0.009
D	1.75	1.90	2.05	0.069	0.075	0.081
E	3.60	3.80	3.90	0.142	0.150	0.154
E1	2.80	2.95	3.10	0.110	0.116	0.122
L	0.50	0.55	0.80	0.020	0.022	0.031
L1	2.10	2.40	2.60	0.083	0.094	0.102
L2	0.45	0.60	0.75	0.018	0.024	0.030
L3	0.20	0.35	0.50	0.008	0.014	0.020

Figure 11. Footprint in millimeters (inches)



### 3 Ordering information

**Table 6. Ordering information**

Order code	Marking	Package	Weight	Base qty	Delivery mode
STPS120MF	F12	STmite flat	16 mg	12000	Tape and reel

### 4 Revision history

**Table 7. Document revision history**

Date	Revision	Changes
15-May-2008	1	First issue.
23-Apr-2014	2	Updated ECOPAK statement.
21-Jul-2015	3	Updated <a href="#">Table 4</a> and reformatted to current standard.

**IMPORTANT NOTICE – PLEASE READ CAREFULLY**

STMicroelectronics NV and its subsidiaries ("ST") reserve the right to make changes, corrections, enhancements, modifications, and improvements to ST products and/or to this document at any time without notice. Purchasers should obtain the latest relevant information on ST products before placing orders. ST products are sold pursuant to ST's terms and conditions of sale in place at the time of order acknowledgement.

Purchasers are solely responsible for the choice, selection, and use of ST products and ST assumes no liability for application assistance or the design of Purchasers' products.

No license, express or implied, to any intellectual property right is granted by ST herein.

Resale of ST products with provisions different from the information set forth herein shall void any warranty granted by ST for such product.

ST and the ST logo are trademarks of ST. All other product or service names are the property of their respective owners.

Information in this document supersedes and replaces information previously supplied in any prior versions of this document.

© 2015 STMicroelectronics – All rights reserved