

**Model 73029**  
**MMCX JACK STRAIGHT CRIMP, RG174, 316**



Model 73029 MMCX JACK STRAIGHT CRIMP, RG174, 316

Snap-on coupling and micro-miniature size for fast connect and disconnect where space is limited

**Features**

- DC - 4 GHz bandwidth.
- 50% smaller than MCX connectors.
- Connectors allow rotation of 360° for layout flexibility.
- Non-slotted contact design for low RF leakage.
- Meets CECC 22340.
- Perfect for applications where space, weight, performance and ease of assembly are required.

**Materials**

- Body is machined brass with gold plating.
- Center contacts – Plug is gold plated Phosphor bronze and Jack is gold plated beryllium copper.
- High quality PTFE insulators.
- Crimp Ferrules are gold or nickel plated copper.

**Ordering Information**

Model: 73029  
Description: MMCX JACK STRAIGHT CRIMP, RG174, 316

USA: Sales: 800-490-2361  
Technical Support: [technicalsupport@pomonatest.com](mailto:technicalsupport@pomonatest.com)  
Fax: 425-446-5844

Europe: 31-(0) 40 2675 150 International: 425-446-5500

Where to Buy: [www.pomonaelectronics.com](http://www.pomonaelectronics.com)

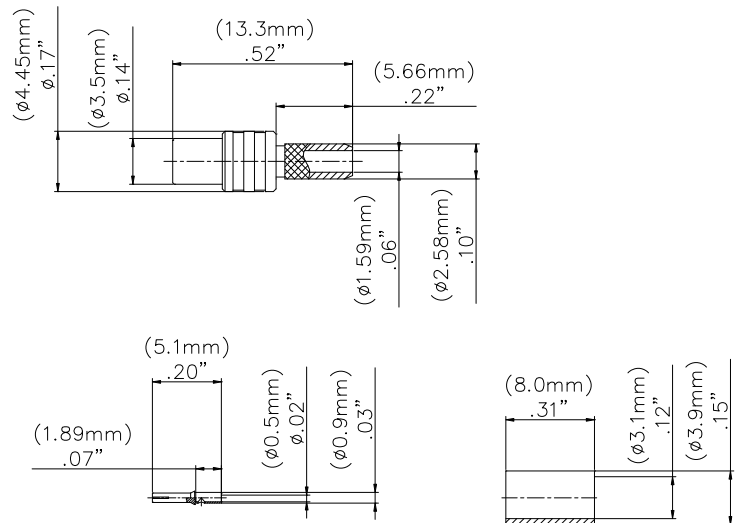

**Specifications**

Impedance	50 $\Omega$
Frequency Range	DC - 4 GHz
Working Voltage	170 Vrms max.
Dielectric Withstanding Voltage	750 Vrms
VSWR	1.3 max
Center / Outer contact resistance	6 / 1 m $\Omega$
Number of insertions	500 cycles minimum
Insulation resistance	> 1000 M $\Omega$
Temperature Range	-55° C to 155° C, -67° F to 311° F

All dimensions are in inches. Tolerances (except noted): .xx =  $\pm .02"$  (.51 mm), .xxx =  $\pm .005"$  (.127 mm). All specifications are to the latest revisions. Specifications are subject to change without notice. Registered trademarks are the property of their respective companies.  
D2003460 REV 001

**Model 73029**  
**MMCX JACK STRAIGHT CRIMP, RG174, 316**

**Cable Types and Crimp Die Information**

Connector Model #	Cable Groups	Crimp Die Cavity Size for Outer Ferrule
73029	RG174, 316	.128 (3.3)

**Cable Assembly Instructions**

1. CUT CABLE END EVENLY AND PERPENDICULAR



2. SLIDE OUTER FERRULE OVER CABLE END.

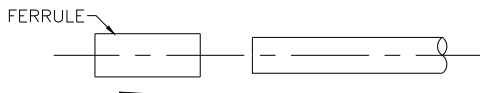

3. STRIP CABLE JACKET, BRAID, AND DIELECTRIC TO SPECIFICATION LENGTHS.

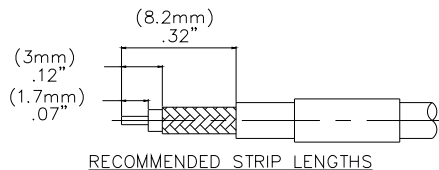

4. INSERT CONTACT PIN ONTO CABLE'S CENTER CONDUCTOR SO THAT IT IS FLUSH TO DIELECTRIC, CRIMP OR SOLDER CONTACT FIRMLY.

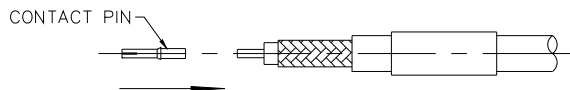

5. FLARE BRAID END SLIGHTLY.

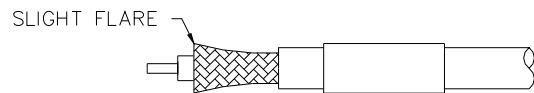

6. INSERT CENTER CONTACT OVER CABLE CENTER CONDUCTOR FLUSH UNTIL FLUSH WITH DIELECTRIC.

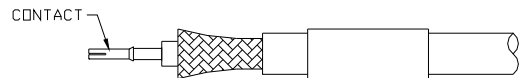

7. SLIDE CONNECTOR BODY OVER CENTER CONTACT AND. SLIDE OUTER FERRULE OVER BRAID AND UP AGAINST BODY ASSEMBLY.

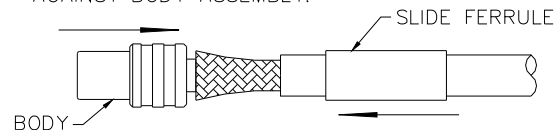

8. CRIMP OUTER FERRULE WITH APPROPRIATE CRIMP TOOL.

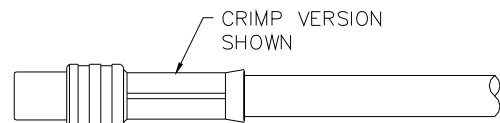

**USA:** Sales: 800-490-2361  
 Technical Support: [technicalsupport@pomonatest.com](mailto:technicalsupport@pomonatest.com)  
 Fax: 425-446-5844  
**Europe:** 31-(0) 40 2675 150 **International:** 425-446-5500  
**Where to Buy:** [www.pomonaelectronics.com](http://www.pomonaelectronics.com)

All dimensions are in inches. Tolerances (except noted): .xx = ±.02" (.51 mm), .xxx = ±.005" (.127 mm). All specifications are to the latest revisions. Specifications are subject to change without notice. Registered trademarks are the property of their respective companies.  
 D2003460 REV 001