



PX-xxxG5Le-72 Series

2.5" SATA Solid State Drive

Engineering Specification

(for Advantech)

Version: 1.0

Status: Proposal

Revision Date: 2013/08/19

Document No.: HSR027_13SSDX-005

LITE-ON IT CORPORATION

Table of Contents

1	Introduction	4
2	Features	4
3	Block Diagram	5
4	Basic Specifications.....	6
4.1	Capacity.....	6
4.1.1	Physical Capacity	6
4.1.2	User Capacity	6
4.2	Flash Type	6
4.3	Program/Erase Cycle	6
4.4	ECC Ability	6
4.5	Buffer Memory Size	6
4.6	Compatibility	7
4.7	Temperature Sensor (Optional)	7
4.8	Band Performance	7
4.9	Read and Write IOPS (IOMETER)	7
4.10	Power On to Ready	8
4.11	Temperature	8
4.12	Reliability	9
4.13	Shock and Vibration	9
4.14	Altitude	10
4.15	Angle	10
4.16	Rattle Noise	10
4.17	Operating noise	10
4.18	Electromagnetic Compatibility of PX-xxxG5Le-72	10
5	Power Supply.....	11
5.1	Power Interface.....	11
5.2	Current Consumption	11
5.3	Power ON Reset.....	11
5.4	Power Off Sequence	12
5.5	Power Mode	13
5.6	Temperature Sensor	13
6	Outline and Dimension	14
7	Pin Locations and Definition.....	15
7.1	Pin Location.....	15
7.2	Signal Description	15
8	Handling Recommendation.....	17
17		
9	Command Description.....	18

9.1 ATA Command	18
9.2 Vendor Specify Command: Get Temperature Command (Optional)	21
9.3 Identify Device Data	22

References.....	27
------------------------	-----------

Terms and Acronyms.....	28
--------------------------------	-----------

Table 1 User Addressable Sectors	6
Table 2 Maximum Sustained Read and Write Bandwidth	7
Table 3 Random Read/Write Input/output Operations per Second	7
Table 4 Latency Specifications.....	8
Table 5 Temperature Relative Specifications	8
Table 6 Reliability specifications	9
Table 7 Shock and Vibration	9
Table 8 Radio Frequency Specifications	10
Table 10 Operating Voltage	11
Table 11 Current Consumption.....	11
Table 12 Power On Reset Characteristics.....	11
Table 13 DC Characteristics.....	13
Table 14 Pin Name.....	15
Figure 1 Block Diagram.....	5
Figure 2 Buffer Memory.....	6
Figure 3 Power On Reset.....	12
Figure 4 Power off sequence	12
Figure 5 Power Mode.....	13

1 Introduction

The **PX-xxxG5Le-72** 2.5" SATA Solid State Drive (SSD) deliver leading performance in an industry standard 2.5" form factor while simultaneously improving system responsiveness over standard rotating drive media or hard disk drives. By combining leading NAND flash memory technology with our innovative high performance firmware; LITE-ON IT delivers 2.5" SATA SSD drives drop-in replacement with enhanced performance, reliability, ruggedness and power savings. Since there are no rotating platters, moving heads, fragile actuators, or unnecessary delays due to spin-up time or positional seek time that can slow down the storage subsystem, significant I/O and throughput performance improvement is achieved as compared to rotating media or hard disk drives. This document describes the specifications of the **PX-xxxG5Le-72** 2.5" SATA Solid State Drive (SSD) form factors.

The **PX-xxxG5Le-72** 2.5" SATA SSD key attributes include high performance, low power, increased system responsiveness, high reliability, and enhanced ruggedness as compared to standard SATA hard drives. The **PX-xxxG5Le-72** 2.5" SATA SSD is available in a 2.5" form factor that is electrically, mechanically, and software compatible with existing 2.5" SATA slots and cables. Our flexible design allows interchangeability with existing mobile hard drives based on the SATA interface standard.

2 Features

- High speed mass storage device
- S-ATA III 6.0G interface
- No movement parts and noise free
- Excellent ability against Shock/Vibration
- Fast access performance
- Temperature detection
- Form Factor:
2.5" SSD form factor



3 Block Diagram

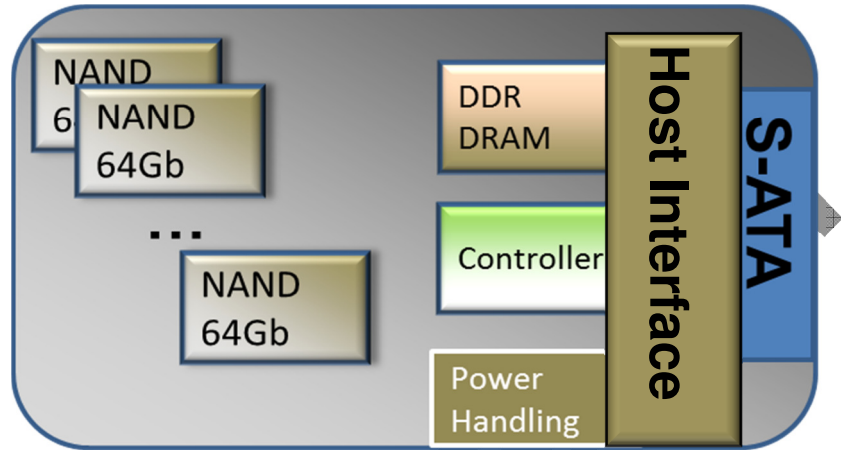

Figure 1 Block Diagram

LiteOn IT Confidential

4 Basic Specifications

4.0 Key Component and FW Version

- 4.0.1 **Flash Type:** Toshiba 19nm
- 4.0.2 **Controller:** Marvell Monet Lite 9188
- 4.0.3 **FW Version:** FW Version:1.02

4.1 Capacity

4.1.1 Physical Capacity

- 32GB, PX-32G5Le-72
- 64GB, PX-64G5Le-72

4.1.2 User Capacity

Unformatted capacity	Total user addressable sectors in LBA mode
32GB	62,533,296
64GB	125,045,424

Table 1 User Addressable Sectors

- Notes:** 1. 1GB=1,000,000,000 bytes and not all of the memory can be used for storage.
 2. 1 Sector = 512 bytes

4.2 Flash Type

Multi-Level Cell (MLC), **Program/Erase Cycle**
 3000(global)

4.3 ECC Ability

81bits/2KB

4.4 Buffer Memory Size

128MB DDR3, consist of FTL Table and write cache data.

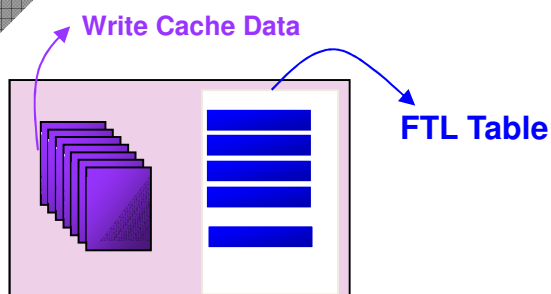

Figure 2 Buffer Memory

4.5 Compatibility

- SATA Revision 3.0 compliant
Compatible with SATA 1.5Gb/s, 3.0Gb/s & 6.0Gb/s Interface rates
- ATA/ATAPI- 8 compliant
- SSD enhanced SMART ATA feature set
- Native Command Queuing (NCQ) command set
- TRIM supported

4.6 Temperature Sensor (Optional)

The temperature information is available from a built-in temperature sensor between -40 °C to +125 °C with ± 3 °C accuracy.

4.7 Band Performance

Capacity	Access Type	MB/s
32GB	Sequential Read	Up to 360 MB/s
	Sequential Write	Up to 80 MB/s
64GB	Sequential Read	Up to 360 MB/s
	Sequential Write	Up to 160 MB/s

Table 2 Maximum Sustained Read and Write Bandwidth

- Notes:** 1). Performance measured using CrystalDiskMark.
 2). 1 MB/sec = 1,048,576 bytes/sec is used in measuring sequential performance.
 If 1 MB/sec = 1,000,000 bytes/sec is used, performance values become 4.85% higher.

4.8 Read and Write IOPS (IOMETER)

Capacity	Access Type	IOPS
32 GB	4K Read (IOPS)	40,000
	4K Write (IOPS)	20,000
64 GB	4K Read (IOPS)	40,000
	4K Write (IOPS)	40,000

Table 3 Random Read/Write Input/output Operations per Second

- Notes:** 1. Performance measured using IOMETER with queue depth set to 1.
 2. Write cache enabled

4.9 Power On to Ready

Operating Mode	Typical (25°C)	Max.(0°C to +70°C)
Power on to Ready	1s	4s

Table 4 Latency Specifications

- Notes:**
1. Write cache enabled
 2. Device measured using Drive Master
 3. Power on to ready time assumes proper shutdown
(Power removal preceded by Flush Cache or STANDBY command)

4.10 Temperature

Environment	Mode	Min	Max	Unit
Ambient Temperature	Operating	0	70	°C
	Non-operation, Storage	-40	90	°C
Humidity	Operation	5	95	%
	Non-operation, Storage	5	95	%
Thermal Gradient	Operation, Non-operation, Storage	5	-	°C/ min

Table 5 Temperature Relative Specifications

4.11 Reliability

Parameter	Value
Mean Time between Failure (MTBF)	1,500,000 Hours
Power on/off cycles	25,000 cycles
Data Reliability	1 per 10 ¹³ bits read (max)
Interface	50 cycles of Insert and Removal operation(min)

Table 6 Reliability specifications

Notes:

1. MTBF is calculated based on a Part Stress Analysis. It assumes nominal voltage. With all other parameters within specified range.
2. Power on/off cycles is defined as power being removed from the drive, and the restored. Application systems remove power with the Flush Cache command or Standby Immediate command in advance before the system shutdown.

4.12 Shock and Vibration

Item	Mode	Timing/Frequency	Max
Shock ¹	Operation Non-operating	At 1 msec half-sine	1500G
	Operation Non-operating	At 2 msec half-sine	1000G
Random Vibration ²	Operation	7~800 Hz	2.17Grms
	Non-operation	7~800 Hz	3.08Grms

Table 7 Shock and Vibration

Notes:

1. Shock specifications assume that the SSD is mounted securely with the input vibration applied to the drive mounting screws. Stimulus may be applied in the X, Y or Z axis
2. Vibration specifications assume that the SSD is mounted securely with the input vibration applied to the drive mounting screws. Stimulus may be applied in the X, Y or Z axis. The measured specification is in root mean squared form.

4.13 Altitude

Operational Altitude: 5,500 meters

Altitude Gradient: 300m / min

4.14 Angle

The drives will operate at any Angle or/and Orientation.

4.15 Rattle Noise

The drives will have no rattle noise during any operation.

Note: There are no movement parts in the SSD drives; the rattle noise will not be tested.

4.16 Operating noise

The operating noise of the module will not exceed 35dBA (20Hz to 20kHz)

Note: There are no movement parts in the SSD drive; the operation noise will not be tested.

4.17 Electromagnetic Compatibility of PX-xxxG5Le-72

Electromagnetic compatibility tests assume the SSD is properly installed in the representative host system. The drive operates properly without errors degradation in performance when subjected to radio frequency (RF) environments defined in the following table.

Test	Description	Performance criteria	Reference standard
Electrostatic discharge	Packaging and Handling Contact $\pm 4KV$ $\pm 8KV$	A	IEC 61000-4-2:2008
Electrostatic discharge	Production and Service Contact $\pm 2KV$	A	IEC 61000-4-2:2008
Radiated Emission	-	-	CISPER-22 Class B

Table 8 Radio Frequency Specifications

Notes:

1. Performance criterion A = The device shall continue to operate as intended, i.e., normal unit operation with no degradation of performance.
2. Performance criterion B = The device shall continue to operate as intended after completion of test, however, during the test, some degradation of performance is allowed as long as there is no data loss operator intervention to restore device function.
3. Performance criterion C = Temporary loss of function is allowed. Operator intervention is acceptable to restore device function.
4. Contact electrostatic discharge is applied to drive enclosure during operation.
5. Contact electrostatic discharge is applied to drive enclosure and I/O pins when Non-Operation.

5 Power Supply

5.1 Power Interface

Description	Specifications
Nominal Supply (V1)	+5Vdc +/- 5%
Absolute Voltage	Min. -0.5V Max. +10V
Ripple voltage (0-20MHz)	150mV p-p max
Supply Rise Time	1 – 100ms

Table 9 Operating Voltage

5.2 Current Consumption

PX-64G5Le-72@ 5V

Operation Mode	Typical	Max.	Unit
Read Mode	0.37	0.5	A
Write Mode	0.42	0.55	A
Standby	0.025	0.04	A
Sleep	0.025	0.04	A
Power On Inrush Current	-	1.0 (T<10ms)	A

Table 10 Current Consumption

Note: Active power is measured using IOMETER Power Consumption with RMS current 5s.

Active Mode: Measured after power on initiation and without activity.

5.3 Power ON Reset

Parameter	Symbol	Min.	Typ.	Max	Unit
Detect voltage Rising	V _{DET}	4.0	4.3	4.4	V
Input voltage high	V _{IH}	2.0	-	-	V
Delay time	t _{delay}	5	-	40	ms

Table 11 Power On Reset Characteristics

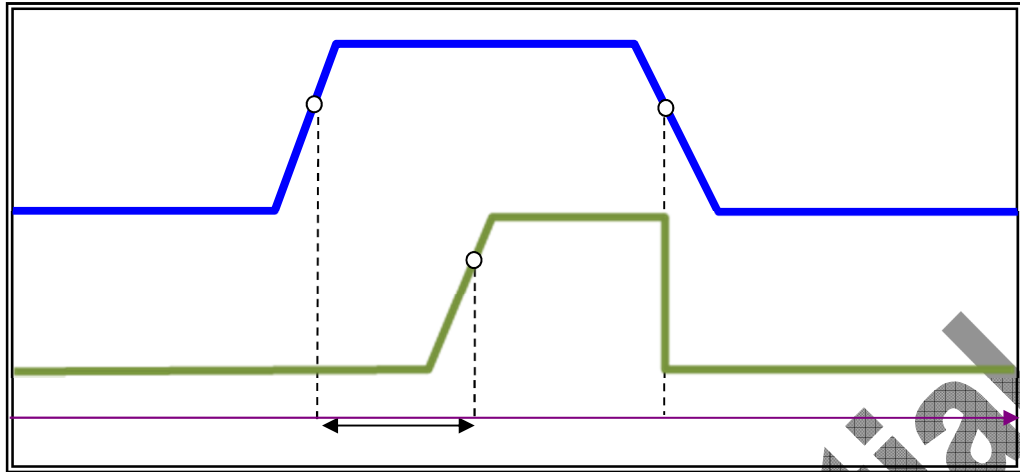

Figure 3 Power On Reset

5.4 Power Off Sequence

Note: Power off without Flush Cache command or Standby Immediate Command in advance may cause cache buffer data which received from host and waiting for programming lose. Please implement the power off sequence as the process in the Figure 4 to prevent the data loss

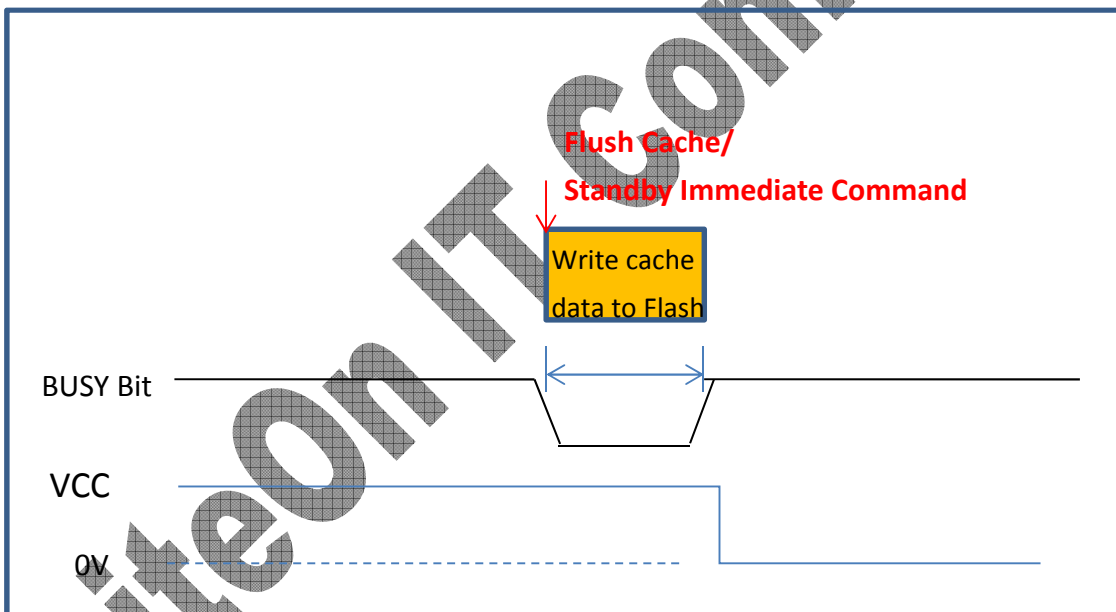

Figure 4 Power off sequence

5.5 Power Mode

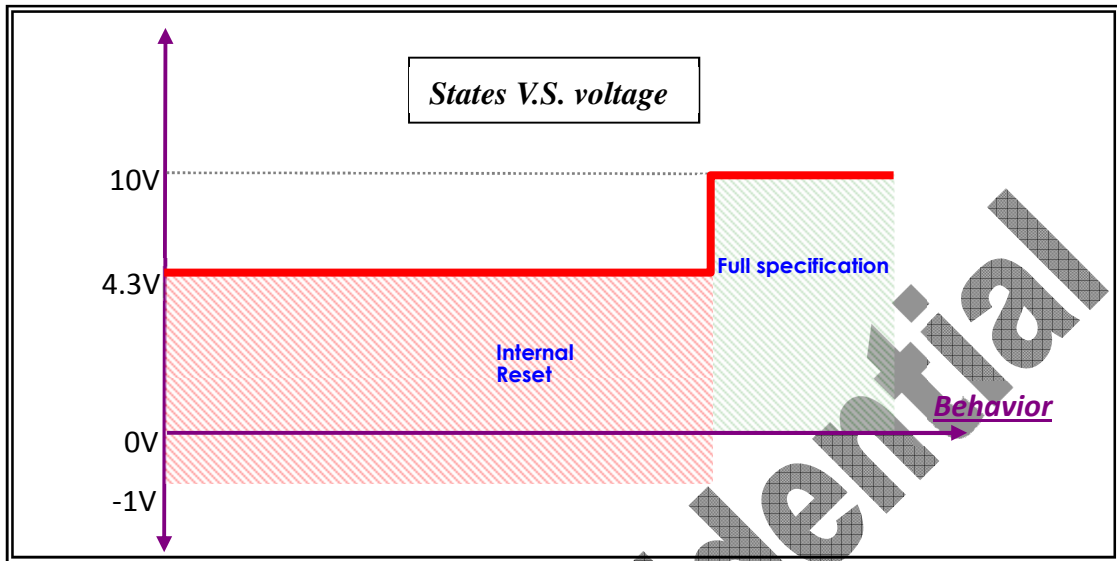

Figure 5 Power Mode

The module has a reset controlled protection implemented.

5.6 Temperature Sensor

Parameter	Symbol	Min.	Typ.	Max	Unit
Temperature range	-	-40	-	+125	°C
Resolution	V_{IL}	-	-	0.25	°C
Temperature error -40~+125°C	T_{ERROR1}	-	-	±3	°C
Temperature error -25~+85°C	T_{ERROR2}	-	-	±2	°C

Table 12 DC Characteristics

6 Outline and Dimension

- 6.1 The module is compliance to SFF-8201
- 6.2 Dimension: 100.0mm x 69.85mm x 6.8 mm (L x W x H)
- 6.3 Weight: **60 g** Max (with case)
- 6.4 The module is capable of taking maximum tightening screw torque of 0.4 Nm
- 6.5 The module is fully functional when subject to Flatness or Co-planarity of 0.5 mm

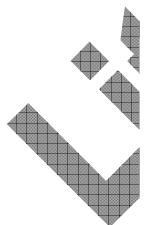
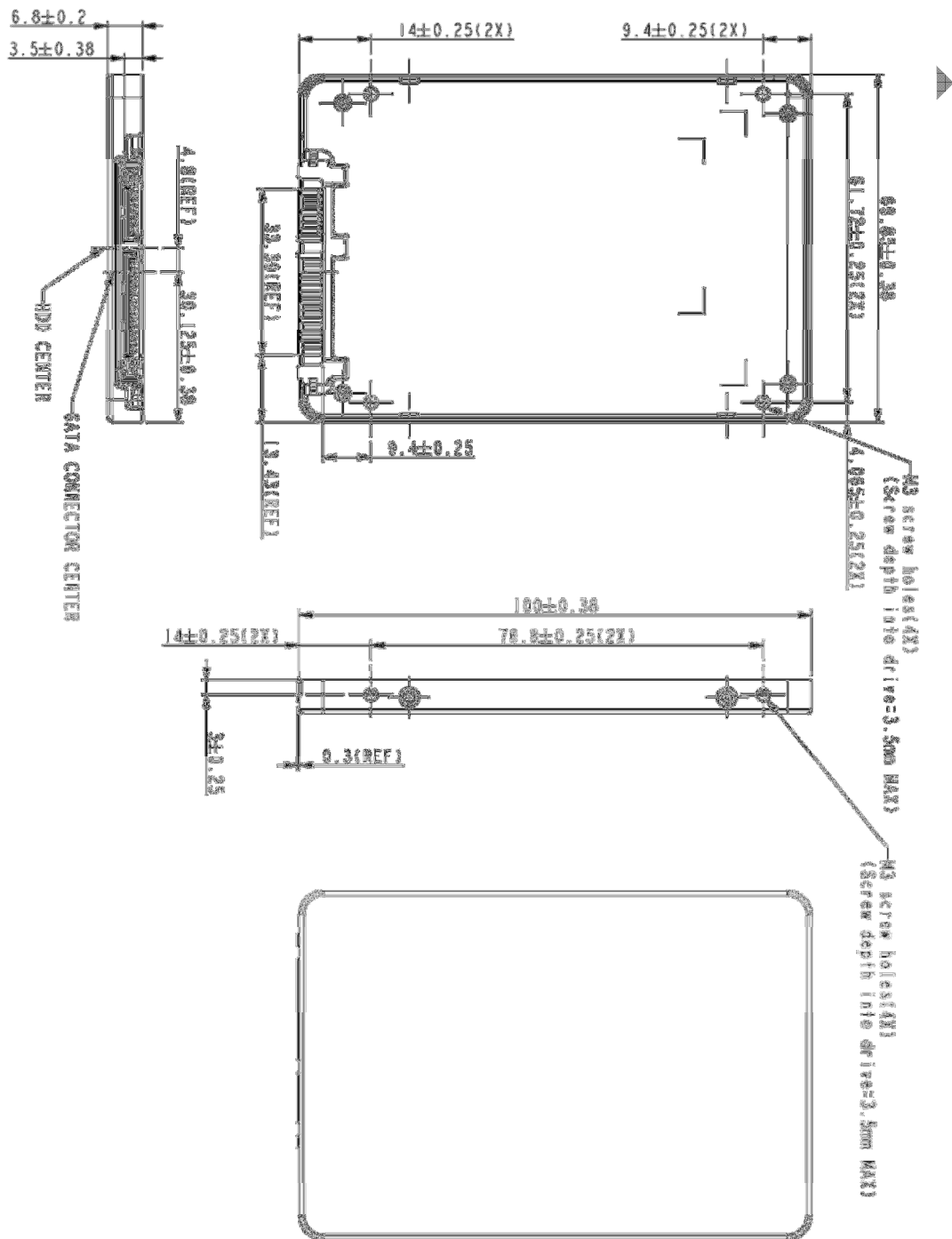

7 Pin Locations and Definition

7.1 Pin Location

The data and power connector pin locations of the **PX-xxxG5Le-72** 2.5" SATA 6 Gb/s SSD are as shown below.

7.2 Signal Description

Data Connector:

1	Type	Description
S1	GND	
S2	A+	Differential Signal Pair A
S3	A-	
S4	GND	
S5	B-	Differential Signal Pair B
S6	B+	
S7	GND	

Power Connector:

Name	Type	Description
P1	V ₃₃	3.3V Power (No Use)
P2	V ₃₃	3.3V Power (No Use)
P3	V ₃₃	3.3V Power, Pre-change (No Use)
P4	GND	
P5	GND	
P6	GND	
P7	V ₅	5V Power, Pre-change
P8	V ₅	5V Power
P9	V ₅	5V Power
P10	GND	
P11	DAS	Device Activity Signal
P12	GND	
P13	V ₁₂	12V Power, Pre-change
P14	V ₁₂	12V Power
P15	V ₁₂	12V Power

Table 13 Pin Name

Note:

1. All pins are in a single row, with a 1.27mm (0.05") pitch
2. Pins P1, P2 and P3 are connected together, although they are not connected internally to the device. The host may put 3.3v on these pins.
3. The mating sequence is
 - The ground pins P4-P6, P10, P12 and the 5V power pin P7
 - The signal pins and the rest of the 5V power pins P8-P9
4. Ground connectors P4 and P12 may contact before the other 1st mate pins in both the power and signal connectors to discharge ESD in a suitably configured backplane connector.
5. Power pins P7, P8 and P9 are internally connected to one another within the device.
6. The host may ground P11 if it is not used for Device Activity Signal (DAS)
7. Pins P13, P14, P15 are connected together, although they are not connected internally to the device.

LiteOn IT Confidential

8 Handling Recommendation



1. The recommended ways to hold the SSD are shown as pictures on the left
2. When handling, keep fingers away from the **S-ATA** connector at all times, as static electricity can damage the electronics inside.
3. Never stack SSDs
4. Please be gentle when inserting the SSD

9 Command Description

9.1 ATA Command

The **PX-xxxG5Le-72** 2.5" SATA SSD support all the mandatory ATA commands defined in the ATA/ATAPI-8 specification.

ATA General Feature Command Set

General feature Command set (non-packet)

- EXECUTE DEVICE DIAGNOSTIC
- FLUSH CACHE
- IDENTIFY DEVICE
- READ DMA
- READ SECTOR(S)
- READ VERIFY SECTORS(S)
- SEEK
- SET FEATURES
- TRIM (*ATA/ATAPI-8 specification)
- WRITE DMA
- WRITE SECTOR(S)
- READ MULTIPLE
- SET MULTIPLE MODE
- WRITE MULTIPLE

Optional commands

- READ BUFFER
- WRITE BUFFER
- NOP
- DOWNLOAD MICROCODE

Power Management Command Set

- CHECK POWER MODE
- IDLE
- IDLE IMMEDIATE
- SLEEP
- STANDBY
- STANDBY IMMEDIATE

Security Mode Feature Set

- SECURITY SET PASSWORD
- SECURITY UNLOCK
- SECURITY ERASE PREPARE
- SECURITY ERASE UNIT
- SECURITY FREEZE LOCK
- SECURITY DISABLE PASSWORD

Host Protected Area Command Set

- READ NATIVE MAX ADDRESS
- SET MAX ADDRESS
- READ NATIVE MAX ADDRESS EXT
- SET MAX ADDRESS EXT

Optional commands.

- SET MAX SET PASSWORD
- SET MAX LOCK
- SET MAX FREEZE LOCK
- SET MAX UNLOCK

48-Bit Address Command Set

- READ NATIVE MAX ADDRESS
- FLUSH CACHE EXT
- READ DMA EXT
- READ NATIVE MAX ADDRESS EXT
- READ SECTOR(S) EXT
- READ VERIFY SECTOR(S) EXT
- SET MAX ADDRESS EXT
- WRITE DMA EXT
- WRITE MULTIPLE EXT
- WRITE SECTOR(S) EXT

SMART Command Set

- SMART ENABLE OPERATIONS
- SMART DISABLE OPERATIONS
- SMART ENABLE/DISABLE AUTOSAVE
- SMART RETURN STATUS

Optional commands.

- SMART EXECUTE OFF-LINE IMMEDIATE
- SMART READ DATA
- SMART READ LOG
- SMART WRITE LOG

The table below lists the SMART commands.

Subcommand	Code	LBA Low value
SMART ATTRIBUTE VALUES (READ DATA)	D0h	
READ ATTRIBUTE THRESHOLDS	D1h	
ENABLE/DISABLE ATTRIBUTE AUTOSAVE	D2h	
SAVE ATTRIBUTE VALUES	D3h	
EXECUTE OFF-LINE IMMEDIATE	D4h	
EXECUTE SMART OFF-LINE ROUTINE		00h
EXECUTE SMART SHORT SELF-TEST ROUTINE (OFFLINE)		01h
EXECUTE SMART EXTENDED SELF-TEST ROUTINE (OFFLINE)		02h
ABORT OFF-LINE ROUTINE		7Fh
EXECUTE SMART SHORT SELF-TEST ROUTINE (CAPTIVE)		81h
EXECUTE SMART EXTENDED SELF-TEST ROUTINE (CAPTIVE)		82h
READ LOG SECTOR	D5h	
WRITE LOG SECTOR	D6h	
ENABLE SMART OPERATIONS	D8h	
DISABLE SMART OPERATIONS	D9h	
RETURN SMART STATUS	DAh	
Enable/Disable Automatic OFFLINE	DBh	

SMART Attributes

- 01h : Raw Read Error Rate
- 05h : Re-allocated Sector Count
- 09h : Power-On Hours Count
- 0Ch : Power Cycle Count
- ADh : Average Program/Erase Count
- B1h : Wear Leveling Count
- B2h : Used Reserved Block Count (Worst Case)
- B5h : Program Fail Count (Total)
- B6h : Erase Fail Count (Total)
- BBh : Uncorrectable Error Count
- C0h : Unsafe Shutdown Count
- C2h : Temperature
- C4h : Reallocate Event Count
- C6h : Offline Uncorrected Error Count
- C7h : CRC Error Count
- E8h : Available reserved space
- F1h : Total Block Written from Host
- F2h : Total Block Read from Host
- F4h : Maximum Program/Erase Count
- F5h : Minimum Program/Erase Count

Temperature (Optional)

The PX-xxxG5Le-72 2.5" SATA SSD provide two kinds of command to access temperature information. One is the temperature value which can be got by OP Code 0xFA. The other is the SMART Attribute ID194.

9.2 Vendor Specify Command: Get Temperature Command (Optional)

9.2.1 OP Code : 0xFA

See the following table for the byte definitions of Return Data:

Byte	Value	Description
0	Temperature	This byte indicates the current temperature in degrees Celsius. Valid values are D8h to 7Dh (-40 to +125).
1-511	00h	Reserved

9.2.2 SMART Attribute C2h

Attribute ID: C2h (194 decimal)

Threshold: None

Description: The Temperature attribute indicates the current drive temperature in degrees Celsius.

See the following table for the byte definitions.

Byte	Value	Description
0	C2h	This is the attribute ID (194 decimal)
1-2	00h	Set to 0200h to indicate the attribute does not trigger an imminent failure (that is, the pre-fail advisory bit is not set).
3	64h	Each of these bytes is set to a constant value, which is always 64h (100 decimal).
4	64h	
5	As description	This byte indicates the current temperature in degrees Celsius. Valid values are D8h to 7Dh (-40 to +125).
6-11	00h	Reserved

9.3 Identify Device Data

The following table details the sector data returned after issuing an IDENTIFY DEVICE command.

Word	F=Fixed V=Variable X=Both	Default Value	Description
0	F	0040h	General configuration bit-significant information
1	F	3FFFh	Obsolete-Number of logical cylinders (16,383)
2	F	C837h	Specific configuration
3	F	0010h	Obsolete-Number of logical heads (16)
4-5	F	0000h	Retired
6	F	003Fh	Obsolete-Number of logical sectors per logical track (63)
7-8	F	0000h	Reserved for assignment by the Compact Flash Association
9	F	0000h	Retired
10-19	V	Var.	Serial number (20 ASCII characters)
20-22	F	0000h	Retired / Obsolete

23-26	V	Var.	Firmware revision (8 ASCII characters)
27-46	V	Var.	Model number
47	F	8010h	7:0 – Maximum number of sectors transferred per interrupt on multiple commands
48	F	4000h	Trusted Computing feature set options, bit14 should be 1
49	F	2F00h	Capabilities
50	F	4000h	Trusted Computing feature set options, bit14 should be 1
51-52	F	0000h	Obsolete
53	F	0007h	Words 88 and 70:64 valid
54	V	Var.	Obsolete - Number of logical cylinders (16,383)
55	V	Var.	Obsolete - Number of logical heads (16)
56	V	Var.	Obsolete - Number of logical sectors per logical track (63)
57-58	V	Var.	Capacity(Cylinders*heads*sectors)
59	V	0101h	Number of sectors transferred per interrupt on multiple commands
60-61	V	03BA2EB0h (32G)/ 07740AB0h(64G)	Total number of user addressable logical sectors for 28-bit commands (DWord)
62	F	0000h	Obsolete
63	V	0007h	Multi-word DMA modes supported/selected
64	F	0003h	PIO modes supported
65	F	0078h	Minimum multiword DMA transfer cycle time per word
66	F	0078h	Manufacture's recommended multiword DMA transfer cycle time
67	F	0078h	Minimum PIO transfer cycle time without flow control
68	F	0078h	Minimum PIO transfer cycle time with IORDY flow control
69-70	F	0000h	Reserved(for future command overlap and queuing)
71-74	F	0000h	Reserved for the IDENTIFY packet DEVICE command
75	F	001Fh	4:0 Maximum Queue depth-1=31
76	F	070Eh	Serial ATA capabilities
77	F	Var.	Current SATA model
78	F	004Ch	Serial ATA features supported

79	F	0040h	Serial ATA features enabled
80	F	01FEh	Major Version Number
81	F	0021h	Minor Version Number
82	F	346Bh	Commands and feature sets supported
83	F	7D01h	Commands and feature sets supported
84	F	4023h	Commands and feature sets supported
85	V	3469h	Commands and feature sets supported or enabled
86	V	BC01h	Commands and feature sets supported or enabled
87	F	4023h	Commands and feature sets supported or enabled
88	V	407Fh	Ultra DMA modes
89	F	0003h	Time required for security erase unit completion
90	F	0003h	Time required for enhanced security erase completion
91	F	0000h	Current advanced power management value
92	V	Var.	Master Password Identifier
93	V	0000h	Hardware reset result. The contents of bits (12:0) of this word shall change only during the execution of a hardware reset.
94	F	0000h	Current AAM value
95	F	0000h	Stream Minimum Request Size
96	F	0000h	Streaming Transfer Time - DMA
97	F	0000h	Streaming Access Latency - DMA and PIO
98-99	F	0000h	Streaming Performance Granularity
100-103	V	03BA2EB0h (32G) / 07740AB0h (64G)	Maximum user LBA for 48-bit Address feature set
104	F	0000h	Streaming Transfer Time - PIO
105	F	0008h	Maximum number of 512-byte blocks per DATA SET MANAGEMENT command
106	F	4000h	Physical sector size/logical sector size
107	F	0000h	Inter-seek delay for ISO-7779 acoustic testing in microseconds
108-111	V	0000h 0000h 0000h 0000h	Worldwide name

112-115	F	0000h	Reserved for word wide name extension to 128 bits
116	F	0000h	Reserved for TLC
117-118	F	0000h	Words per logical sector
119	F	4010h	Commands and feature sets supported
120	F	4010h	Commands and feature sets supported or enabled
121-126	F	0000h	Reserved for expanded supported and enabled settings
127	F	0000h	Removable Media Status Notification feature set support
128	V	0021h	Security status
129-159	F	0000h	Vendor specific
160	F	0000h	Compact Flash Association (CFA) power mode 1
161-167	F	0000h	Reserved for the CompactFlash Association
168	F	0000h	
169	F	0001h	DATA SET MANAGEMENT command is supported
170-173	F	0000h	Additional Product Identifier (ATA String)
174-175	F	0000h	Reserved
176-205	F	0000h	Current media serial number (ATA string)
206	F	003Dh	SCT Command Transport
207-208	F	0000h	Reserved
209	F	4000h	Alignment of logical blocks within a physical block
210-211	F	0000h	Write-Read-Verify Sector Count Mode 3 (DWord)
212-213	F	0000h	Write-Read-Verify Sector Count Mode 2 (DWord)
214	F	0000h	NV Cache Capabilities
215-216	F	0000h	NV Cache Size in Logical Blocks (DWord)
217	F	0001h	Nominal media rotation rate
218	F	0000h	Reserved
219	F	0000h	NV Cache Options
220	F	0000h	7:0 Write-Read-Verify feature set current mode
221	F	0000h	Reserved
222	F	1075h	Transport major version number
223	F	0000h	Transport minor version number
224-229	F	0000h	Reserved
230-233	F	0000h	Extended Number of User Addressable Sectors (QWord)
234	F	0000h	Minimum number of 512-byte data blocks per DOWNLOAD MICROCODE command for mode 03h
235	F	0000h	Minimum number of 512-byte data blocks per DOWNLOAD MICROCODE command for mode 03h

236-254	F	0000h	Reserved
255	V	Var.	Integrity word

LiteOn IT Confidential

References

This document references standards defined by a variety of organizations as listed below.

Date	Title	Location
Dec 2008	VCCI	http://www.vcci.or.jp/vcci_e/general/join/index.html
July 2007	ROHS	Search for material description datasheet at http://intel.pcnaalert.com
April 2004	ATA-7 Spec. Volume 1	http://www.t13.org/
Aug. 2009	ATA-8 Spec. Rev 2	http://www.t13.org/
2008 2008 2004 2005 2008 2008	International Electro Technical Commission EB61000 4-2 Personnel Electrostatic Discharge Immunity 4-3 Electromagnetic compatibility (EMC) 4-4 Electromagnetic compatibility (EMC) 4-5 Electromagnetic compatibility (EMC) 4-6 Electromagnetic compatibility (EMC) 4-11 (Voltage variations)	http://www.iec.ch
2004	ENV 50204 (Radiated electromagnetic field from digital radio telephones)	http://www.iec.ch
2012	HSR027-12SSDX-0108__LITE-ON IT SSD technology 2012_09_07_V03.pdf	Lite-On IT

Terms and Acronyms

This document incorporates many industry and device specific words use the following list to define a variety of terms and acronyms.

Term	Definition
ATA	Advanced Technology Attachment
ATAPI	Advanced Technology Attachment Packet Interface
DIPM	Device Initiated Power Management The ability of the device to request SATA link power state changes
DMA	Direct Memory Access
DRAM	Dynamic Random Access Memory
GB	Giga-byte defined as 1×10^9 bytes
Hot Plug	A term used to describe the removal or insertion of a SATA hard drive when the system is powered on
IOPS	Input output operations per second
LBA	Logical Block Address
MB	Mega-bytes defined as 1×10^6 bytes
MTBF	Mean time between failure
NOP	No operation
OS	Operation System
SMART	Self-Monitoring, Analysis and reporting Technology An open standard for developing hard drive and software systems that automatically monitors a hard drive's health and reports potential problems
SSD	Solid State Drive
WHQL	Microsoft* Windows Hardware Quality Labs
Write Cache	A memory device within a hard drive, which is allocated for the temporary storage of data before that data is copied to its permanent storage location
VCCI	Voluntary Control Council for Interface

Table 18: Glossary of Terms and Acronyms