

DATE	REV	ECN	APP'D. BY
1/31/06	A2	7461	JM
2-23-06	A3	7515	JM
12-14-10	A4	9103	TRM
1-19-1	A5	9124	SMN

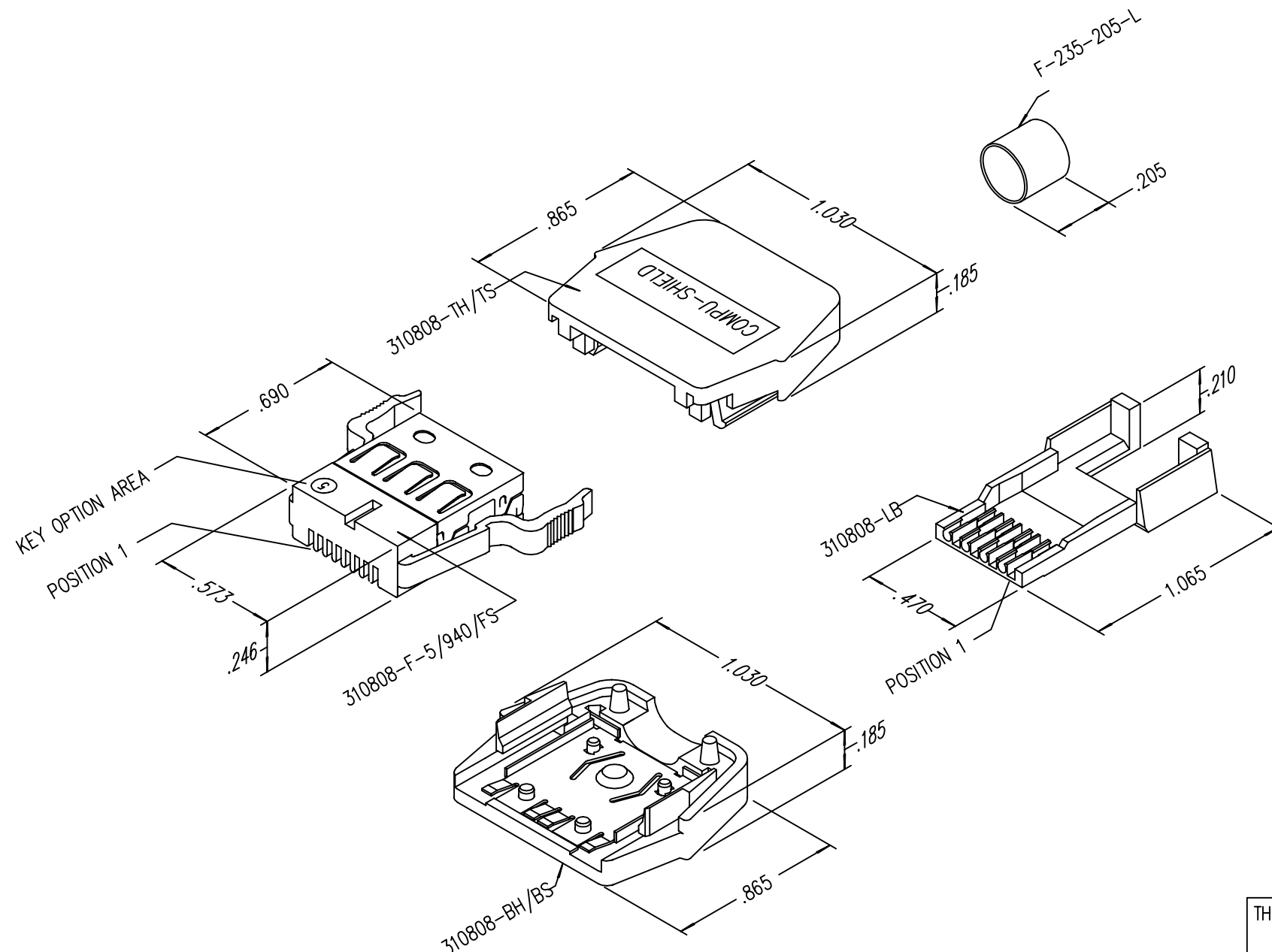

NOTES:

- PLUG MATERIALS:
 TOP/BOTTOM HOUSING: PC UL94 V-0 COLOR: BLACK
 FRONT PLASTIC: PC UL94 V-0 COLOR: CLEAR
 LOAD BAR: PC UL94 V-0 COLOR: CLEAR
 CONTACTS/SHIELD: COPPER ALLOY
 SHIELD PLATING: TIN
 FERRULE PLATING: NICKEL OR TIN
 CONTACT PLATING: SELECTIVE GOLD IN CONTACT AREA
 SEE CHART FOR PART NUMBER
- CONTACTS TERMINATE SOLID OR STRANDED CONDUCTORS UP TO .042" OUTSIDE DIAMETER OF INSULATION
- DIMENSIONS AND TOLERANCES COMPLY WITH TIA-1096 STANDARD.
- HOUSING WILL ACCEPT CABLE UP TO .220" OUTSIDE DIAMETER OF JACKET
- FOR PRODUCT SPECIFICATIONS SEE PRO26-01
- TERMINATED PLUG HEIGHT .234±.002 ON CABLE

50 MICRO-INCHES [1.27um]	SS-310808-5
CONTACT PLATING IN MATING AREA	PART NUMBER

THIRD ANGLE PROJECTION

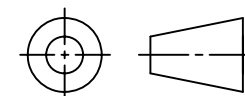

DO NOT SCALE DRAWING
 DRAWING IS SUBJECT TO CHANGE WITHOUT NOTICE

DIMENSIONS: INCHES [METRIC]

UNLESS OTHERWISE SPECIFIED
 TOLERANCES ARE ±.005 [0.13]
 ANGLES ARE ± 1°

SHEET NO. 1 OF 1



Bel Stewart Connector

11118 Susquehanna Trail South
 Glen Rock, PA 17327-9199
 (717) 235-7512 Fax: (717) 235-7954 <http://www.stewartconnector.com>

TITLE: 8X8 COMPU-SHIELD PLUG FINAL ASSEMBLY

THIS DRAWING AND THE SUBJECT MATTER SHOWN THEREON ARE CONFIDENTIAL AND THE PROPRIETARY PROPERTY OF BEL STEWART CONNECTOR AND SHALL NOT BE REPRODUCED, COPIED, OR USED IN ANY MANNER WITHOUT PRIOR WRITTEN CONSENT OF BEL STEWART CONNECTOR. THE SUBJECT MATTER MAY BE PATENTED OR A PATENT MAY BE PENDING.

DRN BY: KRL	DATE 1/31/06
APPD BY: JM	DATE 2-1-06
DWG NO. CT310004	REV. A5