

30V/1.5A Stepping Motor Driver

FEATURES

- 4-phase input (W 1-2phase excitation enabled; exclusive OR function incorporated for simultaneous-ON prevention)
- Built-in CR chopping (with frequency selected)
- Built-in thermal protection and low voltage detection circuit
- Built-in 5V power supply
- 28pin Plastic Small Outline Package With Heat Sink (SOP Type)

DESCRIPTION

AN44065A is a two channels H-bridge driver LSI. Bipolar stepping motor can be controlled by a single driver LSI. 2-phase,1-2(type 2) phase, W1-2 phase can be selected.

APPLICATIONS

- LSI for stepping motor drives

SIMPLIFIED APPLICATION

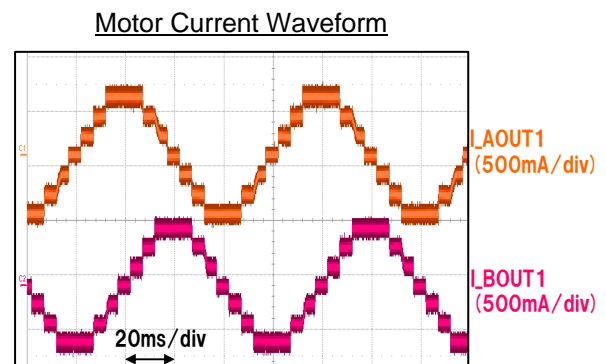
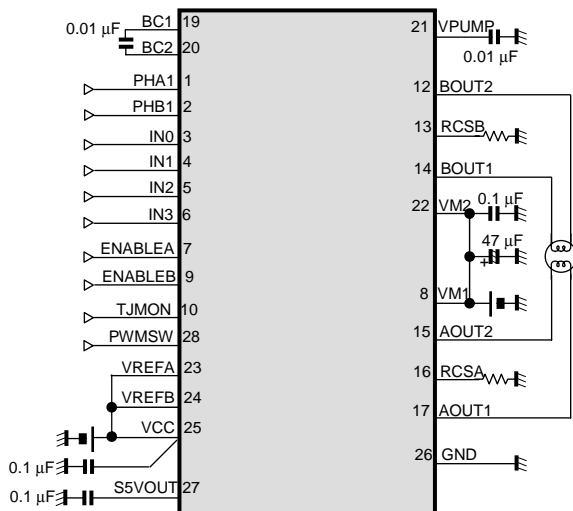

Condition:  
 VM=24V  
 Peak motor current:600mA  
 excitation mode :W1-2 phase drive

Notes)  
 This application circuit is an example. The operation of mass production set is not guaranteed. You should perform enough evaluation and verification on the design of mass production set. You are fully responsible for the incorporation of the above application circuit and information in the design of your equipment.

**ABSOLUTE MAXIMUM RATINGS**

Parameter	Symbol	Rating	Unit	Note
Supply voltage1 (Pin 8,22)	$V_M$	30	V	*3
Supply voltage2 (Pin 25)	$V_{CC}$	-0.3 to +6	V	*3
Power dissipation	$P_D$	0.717	W	*1
Operating ambient temperature	$T_{opr}$	-20 to +70	°C	*2
Operating junction temperature	$T_j$	-20 to +150	°C	*2
Storage temperature	$T_{stg}$	-55 to +150	°C	*2
Output pin voltage (Pin 12,14,15,17)	$V_{OUT}$	30	V	*3
Motor drive current (Pin 12,14,15,17)	$I_{OUT}$	±1.5	A	*3
Flywheel diode current (Pin 12,14,15,17)	$I_f$	1.5	A	*3
Input Voltage Range	$V_{PHA1}, V_{PHB1}$	-0.3 to 6	V	—
	$V_{IN0-IN3}$	-0.3 to 6	V	—
	$V_{ENABLEA}, V_{ENABLEB}$	-0.3 to 6	V	—
	$V_{RCSA}, V_{RCSB}$	-0.5 to 1.5	V	—
	$V_{BC1}$	VM+0.3	V	—
	$V_{BC2}$	(VM-1) to 40	V	—
	$V_{VPUMP}$	(VM-1) to 40	V	—
	$V_{VREFA}, V_{VREFB}$	-0.3 to 6	V	—
	$I_{SSVOUT}$	-7 to 0	mA	—
	$V_{PWMSW}$	-0.3 to 6	V	—
ESD	HBM (Human Body Model)	±2	kV	—
	CDM (Charge Device Model)	±1	kV	—

Notes). This product may sustain permanent damage if subjected to conditions higher than the above stated absolute maximum rating. This rating is the maximum rating and device operating at this range is not guaranteeable as it is higher than our stated recommended operating range.

When subjected under the absolute maximum rating for a long time, the reliability of the product may be affected.

\*1: The power dissipation shown is the value in free-air for the independent LSI package.

\*2: Except for the storage temperature, operating ambient temperature, and power dissipation all ratings are for  $T_a = 25^\circ\text{C}$ . Refer to the package power dissipation prepared else and use under the condition not exceeding the allowable value.

\*3: Do not apply current or voltage from outside to any pin not listed above.

In the circuit current, (+) means the current flowing into LSI and (-) means the current flowing out of LSI.

**POWER DISSIPATION RATING**

Condition	$\theta_{JA}$	PD (Ta=25 °C)	PD (Ta=70 °C)
Mount on PWB *1	48.8 °C/W	2561mW	1639mW
Without PWB	111.6 °C/W	1120mW	717mW

Note). For the actual usage, please refer to the PD-Ta characteristics diagram in the package specification, supply voltage, load and ambient temperature conditions to ensure that there is enough margin follow the power and the thermal design does not exceed the allowable value.

\*1: 2Layer:75X75X1.6t(mm)



**CAUTION**

Although this has limited built-in ESD protection circuit, but permanent damage may occur on it. Therefore, proper ESD precautions are recommended to avoid electrostatic damage to the MOS gates

**RECOMMENDED OPERATING CONDITIONS**

Parameter	Symbol	Min.	Typ.	Max.	Unit	Note
Supply voltage range	VM1, VM2	18	24	28	V	*1
	V <sub>CC</sub>	4.5	5	5.5	V	*1
Input Voltage Range	V <sub>PHA1</sub> , V <sub>PHB1</sub>	0	-	V <sub>CC</sub>	V	—
	V <sub>IN0-IN3</sub>	0	-	V <sub>CC</sub>	V	—
	V <sub>ENABLEA</sub> , V <sub>ENABLEB</sub>	0	-	V <sub>CC</sub>	V	—
	V <sub>VREFA</sub> , V <sub>VREFB</sub>	0	-	5	V	—
	V <sub>PWMSW</sub>	0	-	V <sub>CC</sub>	V	—
External Constants	C <sub>BC</sub>	-	0.01	-	μF	—
	C <sub>VPUMP</sub>	-	0.01	-	μF	—
	C <sub>SSVOUT</sub>	-	0.1	-	μF	—
Operating ambient temperature	Ta <sup>opr</sup>	-20	-	70	°C	—
Operating junction temperature	Tj <sup>opr</sup>	-	-	120	°C	—

Note) \*1: The values under the condition not exceeding the above absolute maximum ratings and the power dissipation.

**ELECTRICAL CHARACTERISTICS**

Note)  $V_M = 24\text{ V}$ ,  $V_{CC} = 5\text{ V}$ ,  $T_a = 25^\circ\text{C} \pm 2^\circ\text{C}$  unless otherwise specified.

\*1 : Typical Value checked by design.

Parameter	Symbol	Condition	Limits			Unit	Note
			Min	Typ	Max		
<b>Output Drivers</b>							
High-level output saturation voltage	$V_{OH}$	$I = -1.0\text{ A}$	$V_M$ -0.75	$V_M$ -0.5	—	V	—
Low-level output saturation voltage	$V_{OL}$	$I = 1.0\text{ A}$	—	0.55	0.825	V	—
Flywheel diode forward voltage	$V_{DI}$	$I = 1.0\text{ A}$	0.5	1.0	1.5	V	—
Output leakage current 1	$I_{LEAK1}$	$V_{OUT} = 30\text{ V}$ , $V_{RCS} = 0\text{ V}$	—	10	50	$\mu\text{A}$	—
Supply current (with two circuits turned off)	$I_M$	ENABLEA = ENABLEB = 5V	—	3.7	5.7	mA	—
Output slew rate 1	$VT_r$	Rising edge	—	240	—	V/ $\mu\text{s}$	*1
Output slew rate 2	$VT_f$	Falling edge	—	240	—	V/ $\mu\text{s}$	*1
Dead time	$T_D$	—	—	2.2	—	$\mu\text{s}$	*1
<b>I/O Block</b>							
Supply current	$I_{CC}$	ENABLEA = ENABLEB = 5V	—	1.4	2.2	mA	—
High-level IN input voltage	$V_{INH}$	—	2.2	—	$V_{CC}$	V	—
Low-level IN input voltage	$V_{INL}$	—	GND	—	0.6	V	—
High-level IN input current	$I_{INH}$	IN0 = IN1 = IN2 = IN3 = 5V	-10	—	10	$\mu\text{A}$	—
Low-level IN input current	$I_{INL}$	IN0 = IN1 = IN2 = IN3 = 0V	-15	—	15	$\mu\text{A}$	—
High-level PHA1/PHB1 input voltage	$V_{PHAH}$ $V_{PHBH}$	—	2.2	—	$V_{CC}$	V	—
Low-level PHA1/PHB1 input voltage	$V_{PHAL}$ $V_{PHBL}$	—	GND	—	0.6	V	—
High-level PHA1/PHB1 input current	$I_{PHAH}$ $I_{PHBH}$	PHA1 = PHB1 = 5V	25	50	100	$\mu\text{A}$	—
Low-level PHA1/PHB1 input current	$I_{PHAL}$ $I_{PHBL}$	PHA1 = PHB1 = 0V	-15	—	15	$\mu\text{A}$	—
High-level ENABLEA/ENABLEB input voltage	$V_{ENABLEAH}$ $V_{ENABLEBH}$	—	2.2	—	$V_{CC}$	V	—
Low-level ENABLEA/ENABLEB input voltage	$V_{ENABLEAL}$ $V_{ENABLEBL}$	—	GND	—	0.6	V	—
High-level ENABLEA/ENABLEB input current	$I_{ENABLEAH}$ $I_{ENABLEBH}$	ENABLEA = ENABLEB = 5V	-10	—	10	$\mu\text{A}$	—
Low-level ENABLEA/ENABLEB input current	$I_{ENABLEAL}$ $I_{ENABLEBL}$	ENABLEA = ENABLEB = 0V	-15	—	15	$\mu\text{A}$	—
High-level PWMSW input voltage	$V_{PWMSWH}$	—	2.2	—	$V_{CC}$	V	—
Low-level PWMSW input voltage	$V_{PWMSWL}$	—	GND	—	0.6	V	—
High-level PWMSW input current	$I_{PWMSWH}$	PWMSW = 5V	25	50	100	$\mu\text{A}$	—
Low-level PWMSW input current	$I_{PWMSWL}$	PWMSW = 0V	-15	—	15	$\mu\text{A}$	—

**ELECTRICAL CHARACTERISTICS (continued)**

Note)  $V_M = 24\text{ V}$ ,  $V_{CC} = 5\text{ V}$ ,  $T_a = 25^\circ\text{C} \pm 2^\circ\text{C}$  unless otherwise specified.

Parameter	Symbol	Condition	Limits			Unit	Note
			Min	Typ	Max		
<b>Torque Control Block</b>							
Input bias current	$I_{REFA}$ $I_{REFB}$	$V_{REFA} = V_{REFB} = 5\text{ V}$	70	99.5	130	$\mu\text{A}$	—
PWM frequency1	$f_{PWM1}$	$PWMSW = 0\text{ V}$	38	58	78	kHz	—
PWM frequency2	$f_{PWM2}$	$PWMSW = 5\text{ V}$	19	29	39	kHz	—
Pulse blanking time	$T_B$	$V_{REFA} = V_{REFB} = 0\text{ V}$	0.6	1.2	1.8	$\mu\text{s}$	—
Cmp threshold H (100%)	$V_{T_H}$	$IN0 = IN1 = 0\text{ V}$ $IN2 = IN3 = 0\text{ V}$	479	503	528	mV	—
Cmp threshold C (67%)	$V_{T_C}$	$IN0 = 5\text{ V}$ , $IN1 = 0\text{ V}$ $IN2 = 5\text{ V}$ , $IN3 = 0\text{ V}$	308	333	359	mV	—
Cmp threshold L (33%)	$V_{T_L}$	$IN0 = 0\text{ V}$ , $IN1 = 5\text{ V}$ $IN2 = 0\text{ V}$ , $IN3 = 5\text{ V}$	151	167	184	mV	—
<b>Reference Voltage Block</b>							
Reference voltage	$V_{S5VOUT}$	$V_M = 24\text{ V}$ , $I_{S5VOUT} = -2.5\text{ mA}$	4.5	5.0	5.5	V	—
Output impedance	$Z_{S5VOUT}$	$V_M = 24\text{ V}$ , $I_{S5VOUT} = -5\text{ mA}$	—	14	21	$\Omega$	—

**ELECTRICAL CHARACTERISTICS (continued)**

Note)  $V_M = 24\text{ V}$  ,  $V_{CC}=5\text{V}$ ,  $T_a = 25^\circ\text{C}\pm 2^\circ\text{C}$  unless otherwise specified.

Parameter	Symbol	Condition	Limits			Unit	Note
			Min	Typ	Max		
<b>Thermal Protection</b>							
Thermal protection operating temperature	$TSD_{on}$	—	—	155	—	°C	*1
Thermal protection hysteresis width	$\Delta TSD$	—	—	45	—	°C	*1

Note) \*1 : Typical Value checked by design.

**PIN CONFIGURATION**

Top View

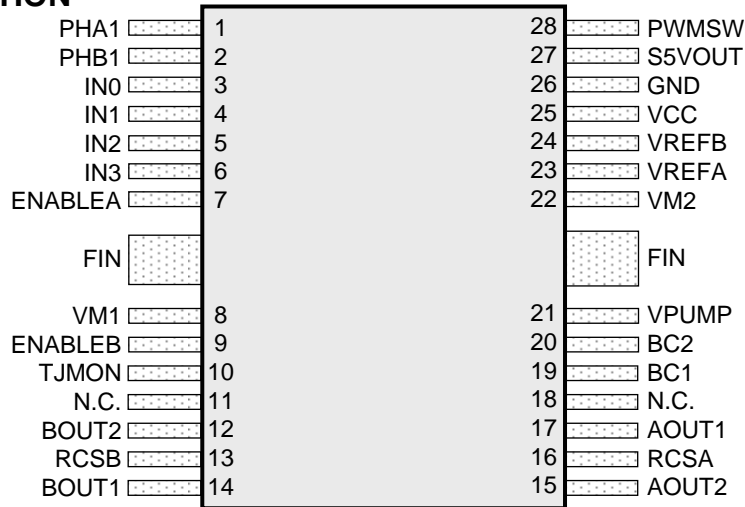

**PIN FUNCTIONS**

Pin No.	Pin name	Type	Description
1	PHA1	Input	Phase A phase selection input
2	PHB1	Input	Phase B phase selection input
3	IN0	Input	Phase A output torque control 1
4	IN1	Input	Phase A output torque control 2
5	IN2	Input	Phase B output torque control 1
6	IN3	Input	Phase B output torque control 2
7	ENABLEA	Input	Phase A Enable/Disable CTL
8	VM1	Power supply	Motor power supply 1
9	ENABLEB	Input	Phase B Enable/Disable CTL
10	TJMON	Output	VBE monitor use
11, 18	N.C.	—	—
12	BOUT2	Output	Phase B motor drive output 2
13	RCSB	Input / Output	Phase B current detection
14	BOUT1	Output	Phase B motor drive output 1
15	AOUT2	Output	Phase A motor drive output 2
16	RCSA	Input / Output	Phase A current detection
17	AOUT1	Output	Phase A motor drive output 1
19	BC1	Output	Charge Pump capacitor connection 1
20	BC2	Output	Charge Pump capacitor connection 2
21	VPUMP	Output	Charge Pump circuit output
22	VM2	Power supply	Motor power supply 2
23	VREFA	Input	Phase A torque reference voltage input
24	VREFB	Input	Phase B torque reference voltage input
25	VCC	Power supply	Signal power supply
26	GND	Ground	Signal ground
27	S5VOUT	Output	Internal reference voltage (5V output)
28	PWMSW	Input	PWM frequency selection input
FIN	FIN	earth	—

Notes) Concerning detail about pin description, please refer to OPERATION and APPLICATION INFORMATION section.

FUNCTIONAL BLOCK DIAGRAM

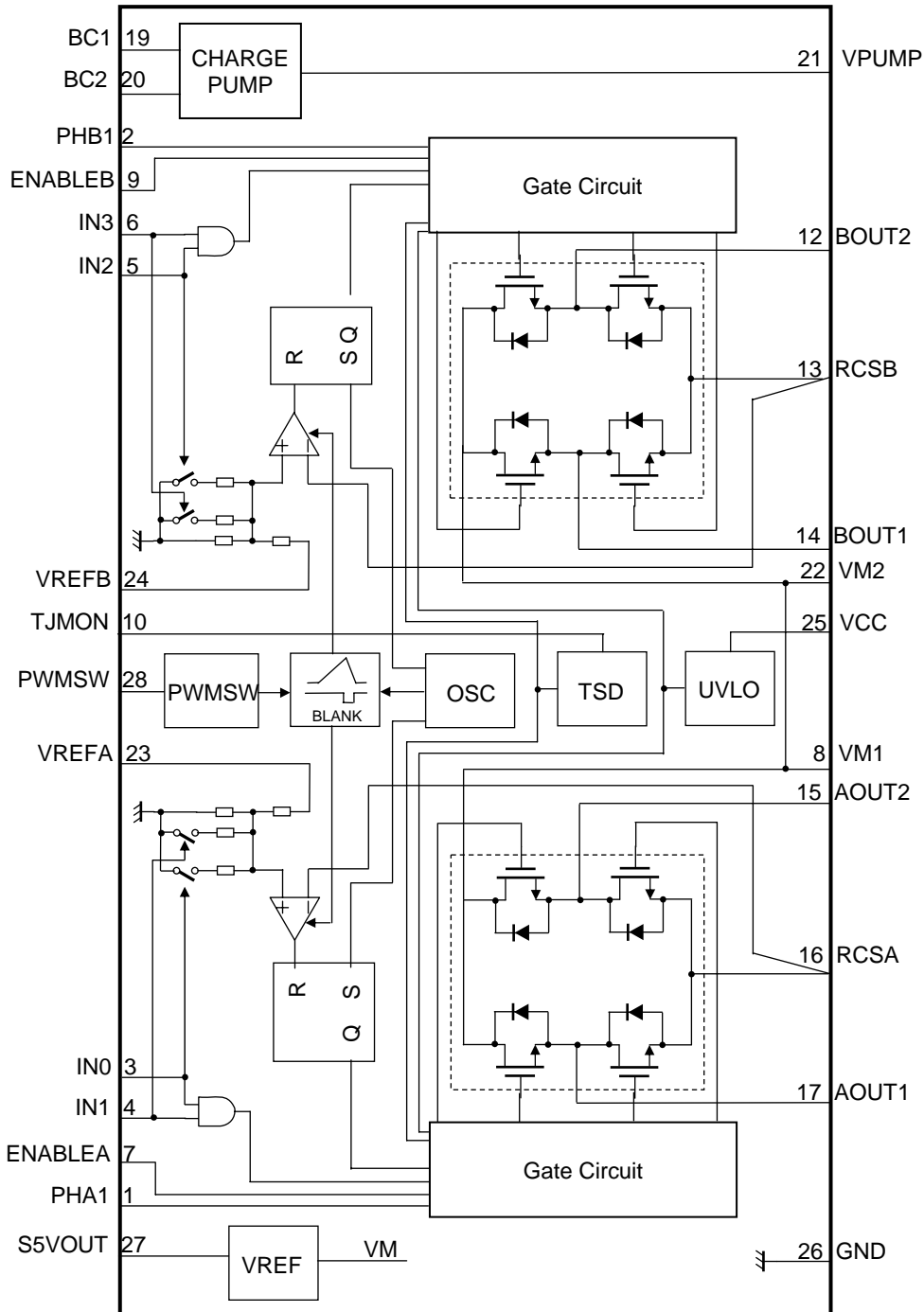

Note) This block diagram is for explaining functions. The part of the block diagram may be omitted, or it may be simplified.



**OPERATION**

**Control mode**

**1.Truth table**

ENABLEA/ENABLEB	PHA1/PHB1	AOUT1/BOUT1	AOUT2/BOUT2
"L"	"H"	"H"	"L"
"L"	"L"	"L"	"H"
"H"	—	OFF	OFF

IN0/IN2	IN1/IN3	Output Current
"L"	"L"	$(V_{REF} / 10) \times (1 / R_s) = I_{OUT}$
"H"	"L"	$(V_{REF} / 10) \times (1 / R_s) \times (2 / 3) = I_{OUT}$
"L"	"H"	$(V_{REF} / 10) \times (1 / R_s) \times (1 / 3) = I_{OUT}$
"H"	"H"	0

Note)  $R_s$  : current detection region

Note) ENABLEA/ENABLEB = "H" or, IN0 = IN1 = "H"/IN2 = IN3 = "H" , output = OFF

**OPERATION ( continued )**

**Control mode(continued)**

**2. drive of full step (4steps sequence)**

(IN0 to IN3 = const.)

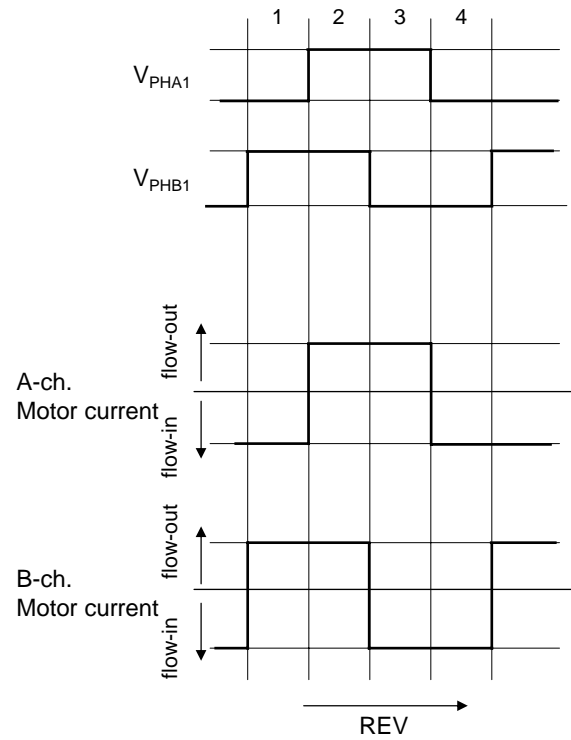
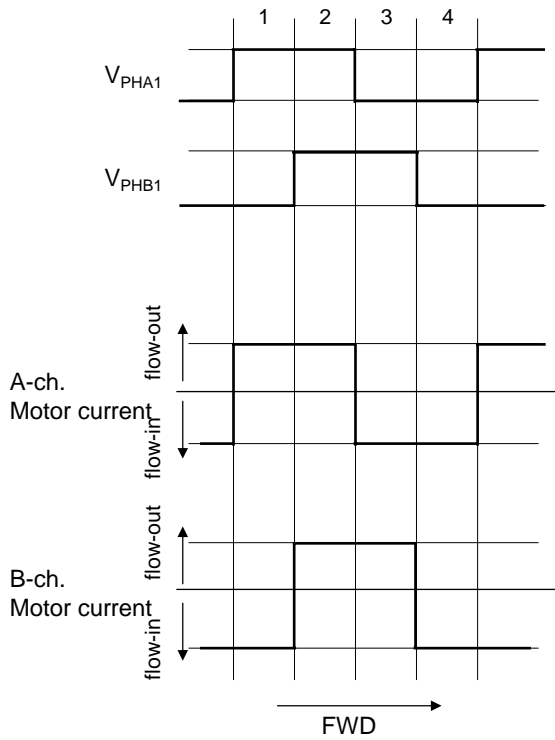

OPERATION ( continued )

Control mode(continued)

3. drive of half step (8steps sequence)

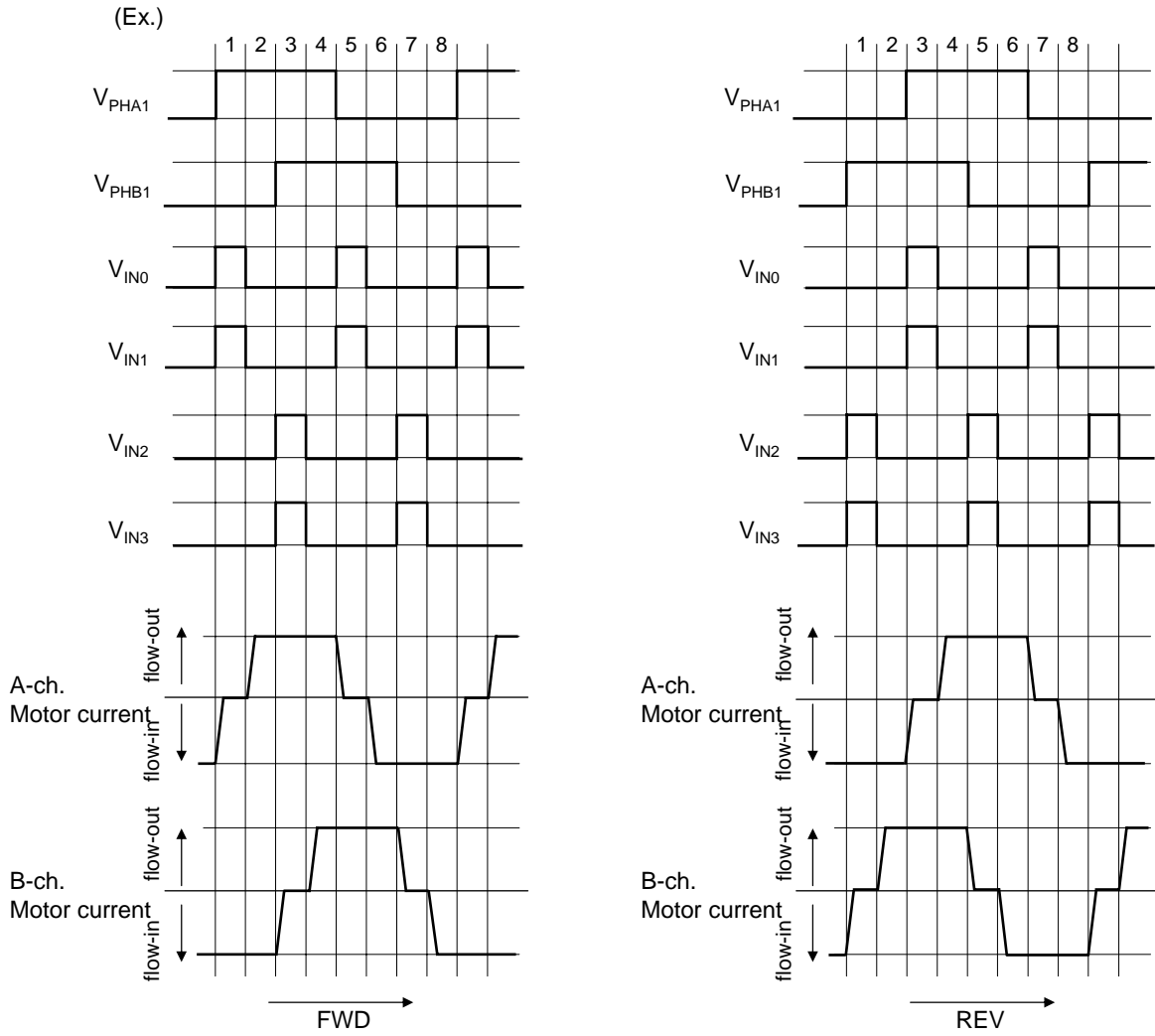

OPERATION ( continued )

Control mode(continued)

4. 1-2 phase excitation (8steps sequence)

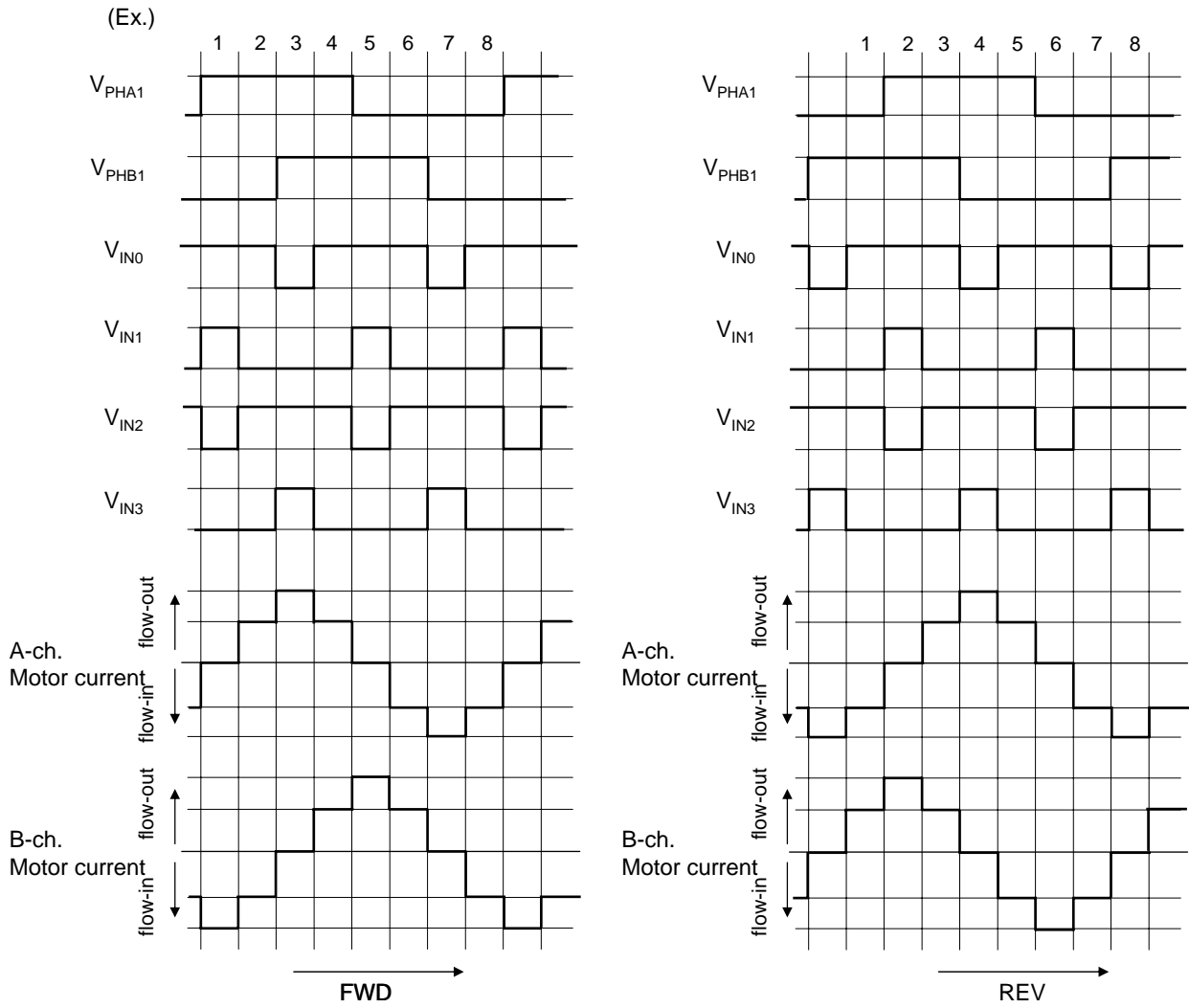

OPERATION ( continued )

Control mode(continued)

5. W1-2phase excitation (16steps sequence)

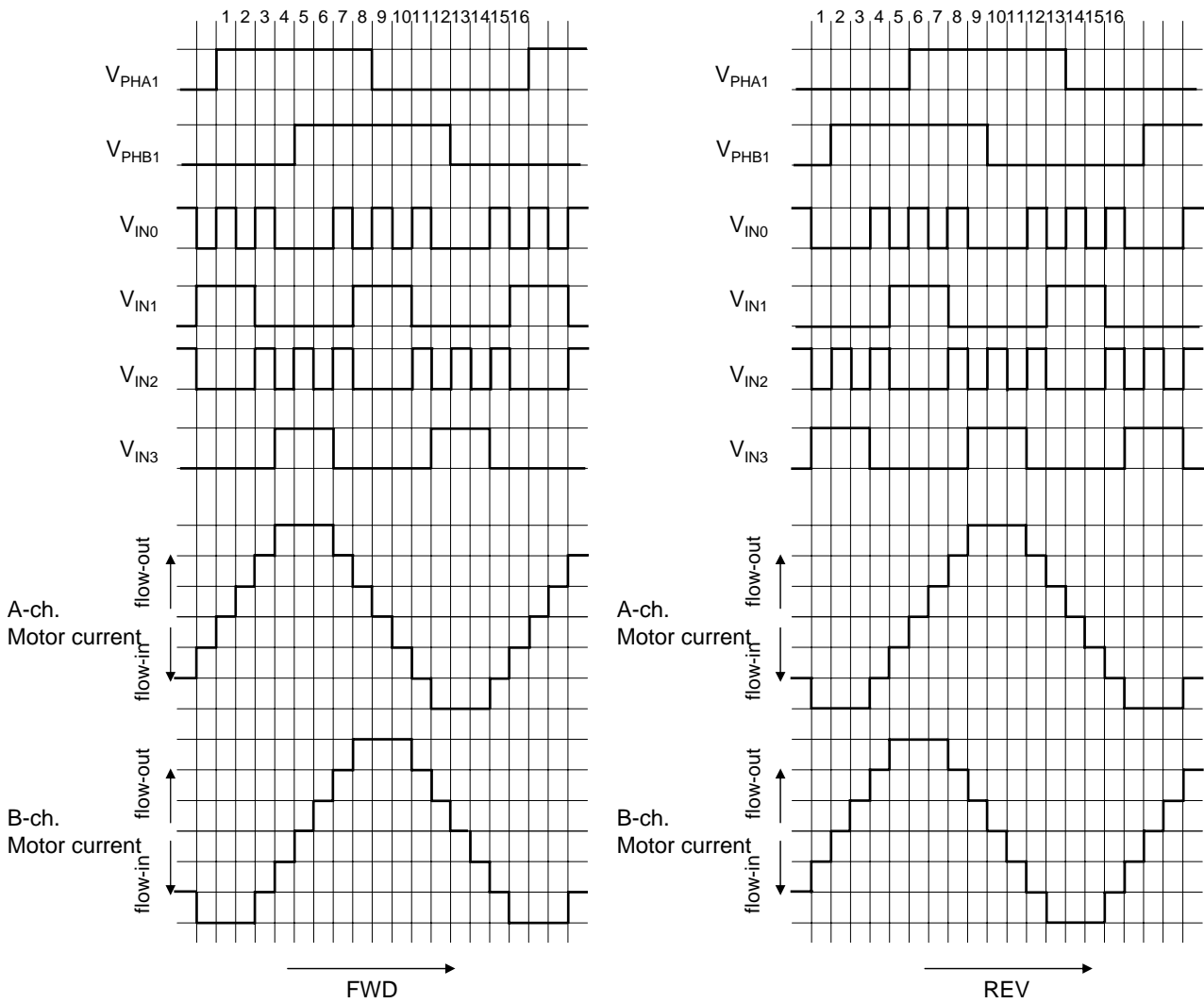

APPLICATIONS INFORMATION

1. Usage Notes

- 1) Set the value of the capacitor between the VPUMP and GND pins so that the voltage on the VPUMP pin (pin 21) will not exceed 40 V in any case regardless of whether it is a transient phenomenon or not while the motor standing by is started.
- 2) This LSI employs a PWM drive method that switches the high-current output of the output transistor. Therefore, the LSI is apt to generate noise that may cause the LSI to malfunction or have fatal damage. To prevent these problems, the power supply must be stable enough. Therefore, the capacitance between the VCC and GND pins must be a minimum of 0.1 μF and the one between the VM and GND pins must be a minimum of 47 μF and as close as possible to the LSI so that PWM noise will not cause the LSI to malfunction or have fatal damage.
- 3) In order to prevent mistakes in current detection resulting noise, this LSI is provided with a pulse blanking time of 1.2 μs (typ.). The motor current will not be less than the current determined by blanking time. Pay utmost attention at the time of minute current control.

The graph on the right-hand side shows the relationship between the pulse blanking time and minute current value.

The increase or decrease in the motor current is determined by the resistance of the internal winding of the motor.

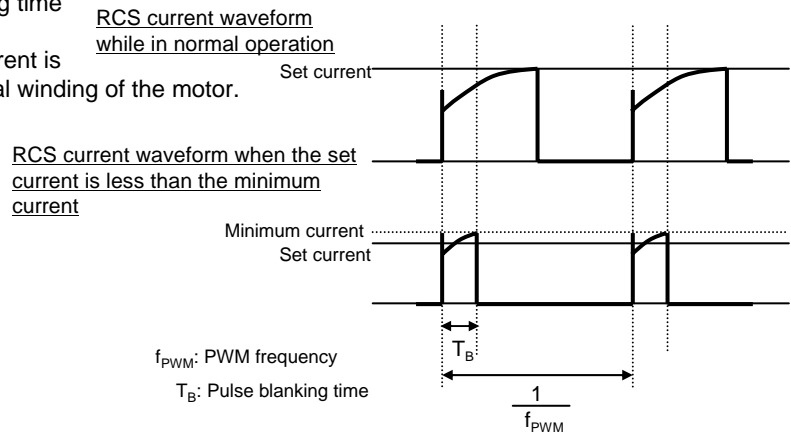

- 4) A high current flows into the LSI. Therefore, the common impedance of the PCB pattern cannot be ignored. Take the following points into consideration and design the PCB pattern of the motor.

A high current flows into the line between the VM1 (pin 8) and VM2 (pin 22) pins. Therefore, noise is generated with ease at the time of switching due to the inductance (L) of the line, which may result in the malfunctioning or destruction of the LSI (see the circuit diagram on the left-hand side). As shown in the circuit diagram on the right-hand side, the escape way of the noise is secured by connecting a capacitor to the connector close to the VM pin of the LSI. This makes it possible to suppress the direct VM pin voltage of the LSI. Make the settings as shown in the circuit diagram on the right-hand side as much as possible.

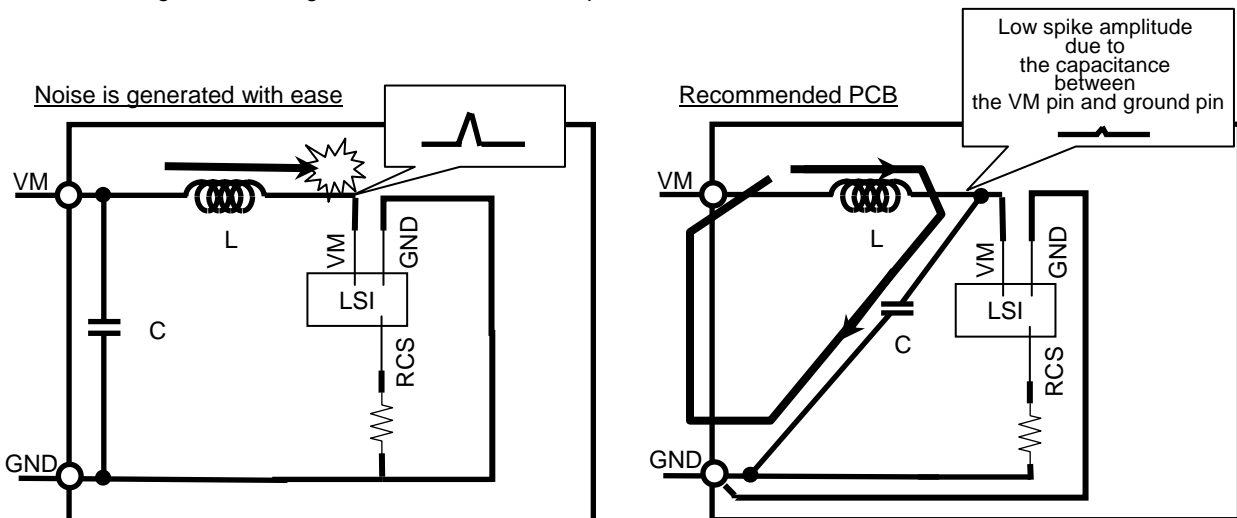

APPLICATIONS INFORMATION ( continued )

1. Usage Notes (continued)

5) In the case of measuring the chip temperature of the LSI, measure the voltage of TJMON(10pin) and presume chip temperature from following data. Use the following data as reference data. Before applying the LSI to a product, conduct a sufficient reliability test of the LSI along with the evaluation of the product with the LSI incorporated.

The temperature characteristic of TJMON

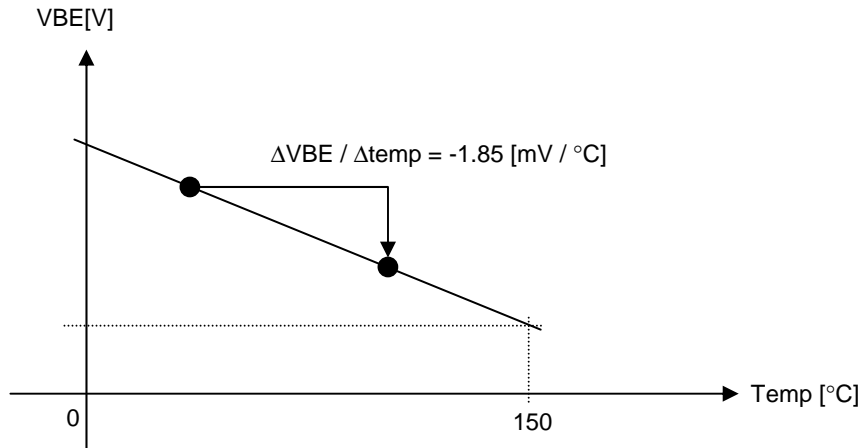

6) Power Supply Sequence

If two types of power supply are used

Rise : This LSI is recommended rise of 5V power supply before rise of 24V power supply.

Fall : Although there is no particular rule, check that VM fall time is about 1sec.

When recommended sequence is difficult, take the diagram below indicates into consideration and design.

Also, rise slew rate design

VM : below 0.1V/μs, VCC : below 0.1V/μs

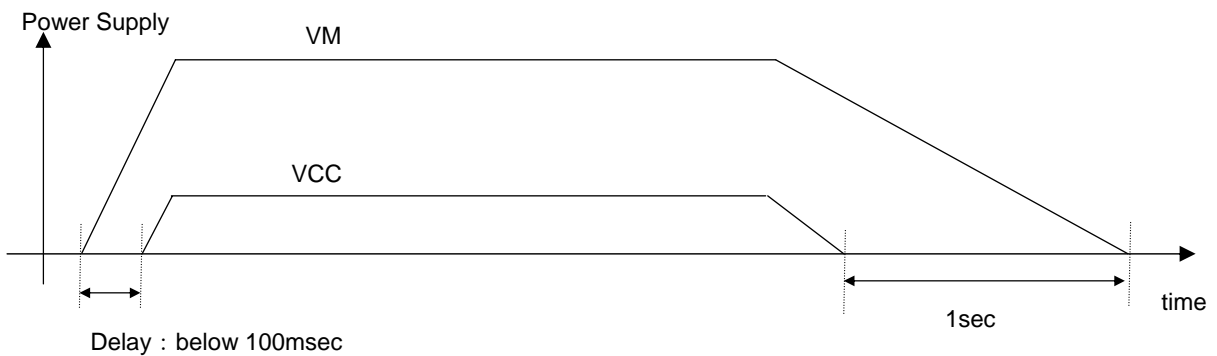

If one type of power supply is used

Rise slew rate design

VM : below 0.1V/μs

7) Check the risk that is caused by the failure of external components.

**PACKAGE INFORMATION ( Reference Data )**

Package Code:HSOP042-P-0400D

unit:mm

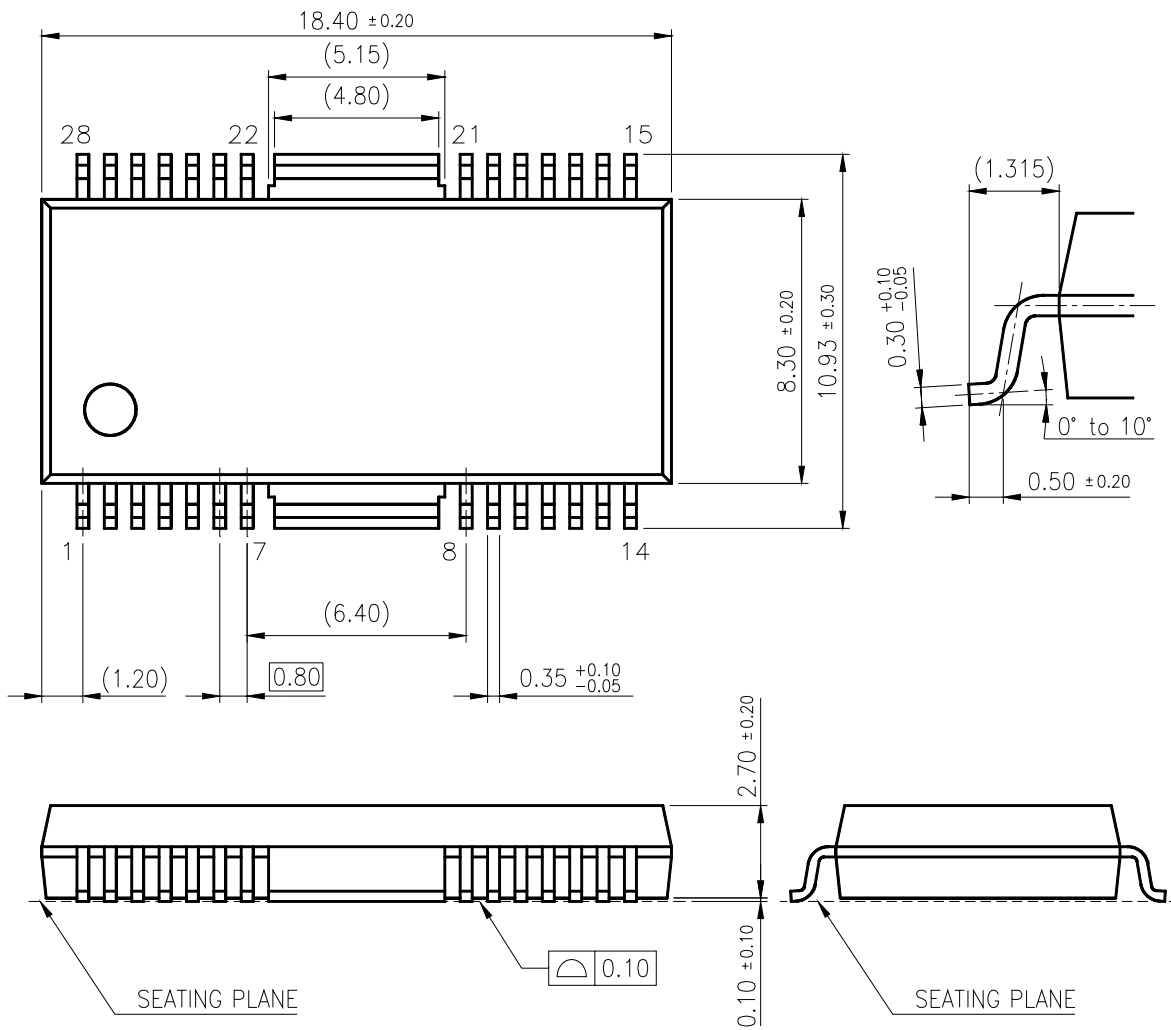

Body Material	: Epoxy Resin
Lead Material	: Cu Alloy
Lead Finish Method	: SnBi Plating



**IMPORTANT NOTICE**

1. The products and product specifications described in this book are subject to change without notice for modification and/or improvement. At the final stage of your design, purchasing, or use of the products, therefore, ask for the most up-to-date Product Standards in advance to make sure that the latest specifications satisfy your requirements.
2. When using the LSI for new models, verify the safety including the long-term reliability for each product.
3. When the application system is designed by using this LSI, be sure to confirm notes in this book.  
Be sure to read the notes to descriptions and the usage notes in the book.
4. The technical information described in this book is intended only to show the main characteristics and application circuit examples of the products. No license is granted in and to any intellectual property right or other right owned by Panasonic Corporation or any other company. Therefore, no responsibility is assumed by our company as to the infringement upon any such right owned by any other company which may arise as a result of the use of technical information de-scribed in this book.
5. This book may be not reprinted or reproduced whether wholly or partially, without the prior written permission of our company.
6. This LSI is intended to be used for general electronic equipment.  
Consult our sales staff in advance for information on the following applications: Special applications in which exceptional quality and reliability are required, or if the failure or malfunction of this LSI may directly jeopardize life or harm the human body.  
Any applications other than the standard applications intended.
  - (1) Space appliance (such as artificial satellite, and rocket)
  - (2) Traffic control equipment (such as for automobile, airplane, train, and ship)
  - (3) Medical equipment for life support
  - (4) Submarine transponder
  - (5) Control equipment for power plant
  - (6) Disaster prevention and security device
  - (7) Weapon
  - (8) Others : Applications of which reliability equivalent to (1) to (7) is requiredIt is to be understood that our company shall not be held responsible for any damage incurred as a result of or in connection with your using the LSI described in this book for any special application, unless our company agrees to your using the LSI in this book for any special application.
7. This LSI is neither designed nor intended for use in automotive applications or environments unless the specific product is designated by our company as compliant with the ISO/TS 16949 requirements.  
Our company shall not be held responsible for any damage incurred by you or any third party as a result of or in connection with your using the LSI in automotive application, unless our company agrees to your using the LSI in this book for such application.
8. If any of the products or technical information described in this book is to be exported or provided to non-residents, the laws and regulations of the exporting country, especially, those with regard to security export control, must be observed.
9. Please use this product in compliance with all applicable laws and regulations that regulate the inclusion or use of controlled substances, including without limitation, the EU RoHS Directive. Our company shall not be held responsible for any damage incurred as a result of your using the LSI not complying with the applicable laws and regulations.

**USAGE NOTES**

1. When designing your equipment, comply with the range of absolute maximum rating and the guaranteed operating conditions (operating power supply voltage and operating environment etc.). Especially, please be careful not to exceed the range of absolute maximum rating on the transient state, such as power-on, power-off and mode-switching. Otherwise, we will not be liable for any defect which may arise later in your equipment.

Even when the products are used within the guaranteed values, take into the consideration of incidence of break down and failure mode, possible to occur to semiconductor products. Measures on the systems such as redundant design, arresting the spread of fire or preventing glitch are recommended in order to prevent physical injury, fire, social damages, for example, by using the products.

2. Comply with the instructions for use in order to prevent breakdown and characteristics change due to external factors (ESD, EOS, thermal stress and mechanical stress) at the time of handling, mounting or at customer's process. When using products for which damp-proof packing is required, satisfy the conditions, such as shelf life and the elapsed time since first opening the packages.
3. Pay attention to the direction of LSI. When mounting it in the wrong direction onto the PCB (printed-circuit-board), it might smoke or ignite.
4. Pay attention in the PCB (printed-circuit-board) pattern layout in order to prevent damage due to short circuit between pins. In addition, refer to the Pin Description for the pin configuration.
5. Perform a visual inspection on the PCB before applying power, otherwise damage might happen due to problems such as a solder-bridge between the pins of the semiconductor device. Also, perform a full technical verification on the assembly quality, because the same damage possibly can happen due to conductive substances, such as solder ball, that adhere to the LSI during transportation.
6. The LSI is destructed under an abnormal condition, such as the short-circuiting between the output and VM pins, output and ground pins, or output pins (i.e., load short-circuiting), in which case smoke may be generated. Pay utmost attention to the use of the LSI.

Pay special attention to the following pins so that they are not short-circuited with the VM pin, ground pin, other output pin, or current detection pin.

(1) AOUT1 (pin 17), AOUT2 (pin 15), BOUT1 (pin 14), BOUT2 (pin 12)

(2) BC2 (pin 20), VPUMP (pin 21)

(3) VM1 (pin 8), VM2 (pin 22), VREG (pin 25)

(4) RCSA (pin 16), RCSB (pin 13)

The higher the current capacity of power supply is, the higher the possibility of the above destruction or smoke generation. Therefore, it is recommended to take safety countermeasures, such as the use of a fuse.

7. The protection circuit is for maintaining safety against abnormal operation. Therefore, the protection circuit should not work during normal operation.  
  
Especially for the thermal protection circuit, if the area of safe operation or the absolute maximum rating is momentarily exceeded due to output pin to VM short (Power supply fault), or output pin to GND short (Ground fault), the LSI might be damaged before the thermal protection circuit could operate.
8. Unless specified in the product specifications, make sure that negative voltage or excessive voltage are not applied to the pins because the device might be damaged, which could happen due to negative voltage or excessive voltage generated during the ON and OFF timing when the inductive load of a motor coil or actuator coils of optical pick-up is being driven.
9. The product which has specified ASO (Area of Safe Operation) should be operated in ASO.
10. Verify the risks which might be caused by the malfunctions of external components.
11. Perform thermal design work with consideration of a sufficient margin to keep the power dissipation based on supply voltage, load, and ambient temperature conditions.  
(The LSI is recommended that junctions are designed below 70~80% of Absolute Maximum Rating.)

## Request for your special attention and precautions in using the technical information and semiconductors described in this book

- (1) If any of the products or technical information described in this book is to be exported or provided to non-residents, the laws and regulations of the exporting country, especially, those with regard to security export control, must be observed.
- (2) The technical information described in this book is intended only to show the main characteristics and application circuit examples of the products. No license is granted in and to any intellectual property right or other right owned by Panasonic Corporation or any other company. Therefore, no responsibility is assumed by our company as to the infringement upon any such right owned by any other company which may arise as a result of the use of technical information described in this book.
- (3) The products described in this book are intended to be used for general applications (such as office equipment, communications equipment, measuring instruments and household appliances), or for specific applications as expressly stated in this book.  
Consult our sales staff in advance for information on the following applications:
  - Special applications (such as for airplanes, aerospace, automotive equipment, traffic signaling equipment, combustion equipment, life support systems and safety devices) in which exceptional quality and reliability are required, or if the failure or malfunction of the products may directly jeopardize life or harm the human body.It is to be understood that our company shall not be held responsible for any damage incurred as a result of or in connection with your using the products described in this book for any special application, unless our company agrees to your using the products in this book for any special application.
- (4) The products and product specifications described in this book are subject to change without notice for modification and/or improvement. At the final stage of your design, purchasing, or use of the products, therefore, ask for the most up-to-date Product Standards in advance to make sure that the latest specifications satisfy your requirements.
- (5) When designing your equipment, comply with the range of absolute maximum rating and the guaranteed operating conditions (operating power supply voltage and operating environment etc.). Especially, please be careful not to exceed the range of absolute maximum rating on the transient state, such as power-on, power-off and mode-switching. Otherwise, we will not be liable for any defect which may arise later in your equipment.  
Even when the products are used within the guaranteed values, take into the consideration of incidence of break down and failure mode, possible to occur to semiconductor products. Measures on the systems such as redundant design, arresting the spread of fire or preventing glitch are recommended in order to prevent physical injury, fire, social damages, for example, by using the products.
- (6) Comply with the instructions for use in order to prevent breakdown and characteristics change due to external factors (ESD, EOS, thermal stress and mechanical stress) at the time of handling, mounting or at customer's process. When using products for which damp-proof packing is required, satisfy the conditions, such as shelf life and the elapsed time since first opening the packages.
- (7) This book may be not reprinted or reproduced whether wholly or partially, without the prior written permission of our company.