

1

2

3

4

5

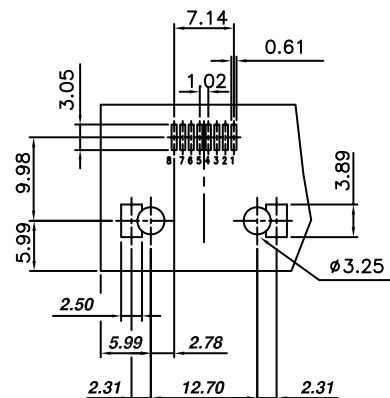
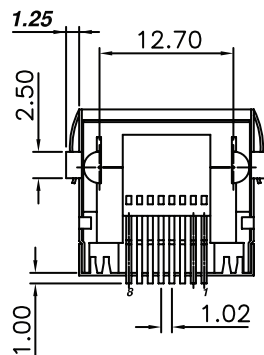

PCB LAYOUT - COMPONENT VIEW

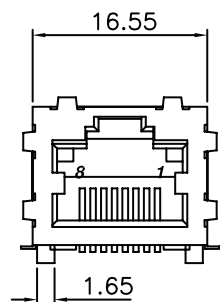
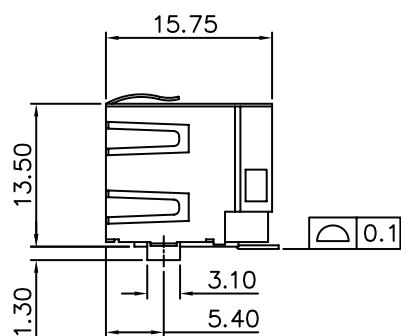

TECHNICAL CHARACTERISTICS

MATERIAL

INSULATOR: - HOUSING: PA 9T
 - INSERT HOUSING: PA 46
 FLAMABILITY RATING: UL94-V0
 COLOR: BLACK
 CONTACT MATERIAL: COPPER ALLOY
 CONTACT TYPE: STAMPED
 CONTACT PLATING: SELECTIVE GOLD
 SHIELDING: BRASS NI PLATED
 QUALITY CLASS: 500 MATING CYLCES

ENVIRONMENTAL

OPERATING TEMPERATURE: -40°C UP TO +85°C
 COMPLIANCE: LEAD FREE AND ROHS

ELECTRICAL

CURRENT RATING: 1.5A
 WORKING VOLTAGE: 120V AC
 INSULATION RESISTANCE: >500 MΩ
 WITHSTANDING VOLTAGE: 1000 VAC/min
 CONTACT RESISTANCE: 20 mΩ max

STANDARD

 CERTIFIED: E324776

SOLDERING

JEDEC LEAD FREE REFLOW SOLDERING PROCESS

PACKAGING

TRAY

RoHS Compliant

PROJECTION:



GENERAL TOLERANCE

.X = +/- 0.3

.XX = +/- 0.25



APPROVAL: RJ

UNIT: MM

DESCRIPTION: HORIZONTAL SHIELDED SMT WITH EMI PANEL FINGER 8P8C

SIZE

SCALE:

WERI PART NO: 634 008 149 721

A4

SHEET: 1/3

DRAW: AS

G			
F			
E			
D			
C			
B			
A	10-SEP14	PDF	AS
REV	DATE	FILE	BY

1

2

3

4

5

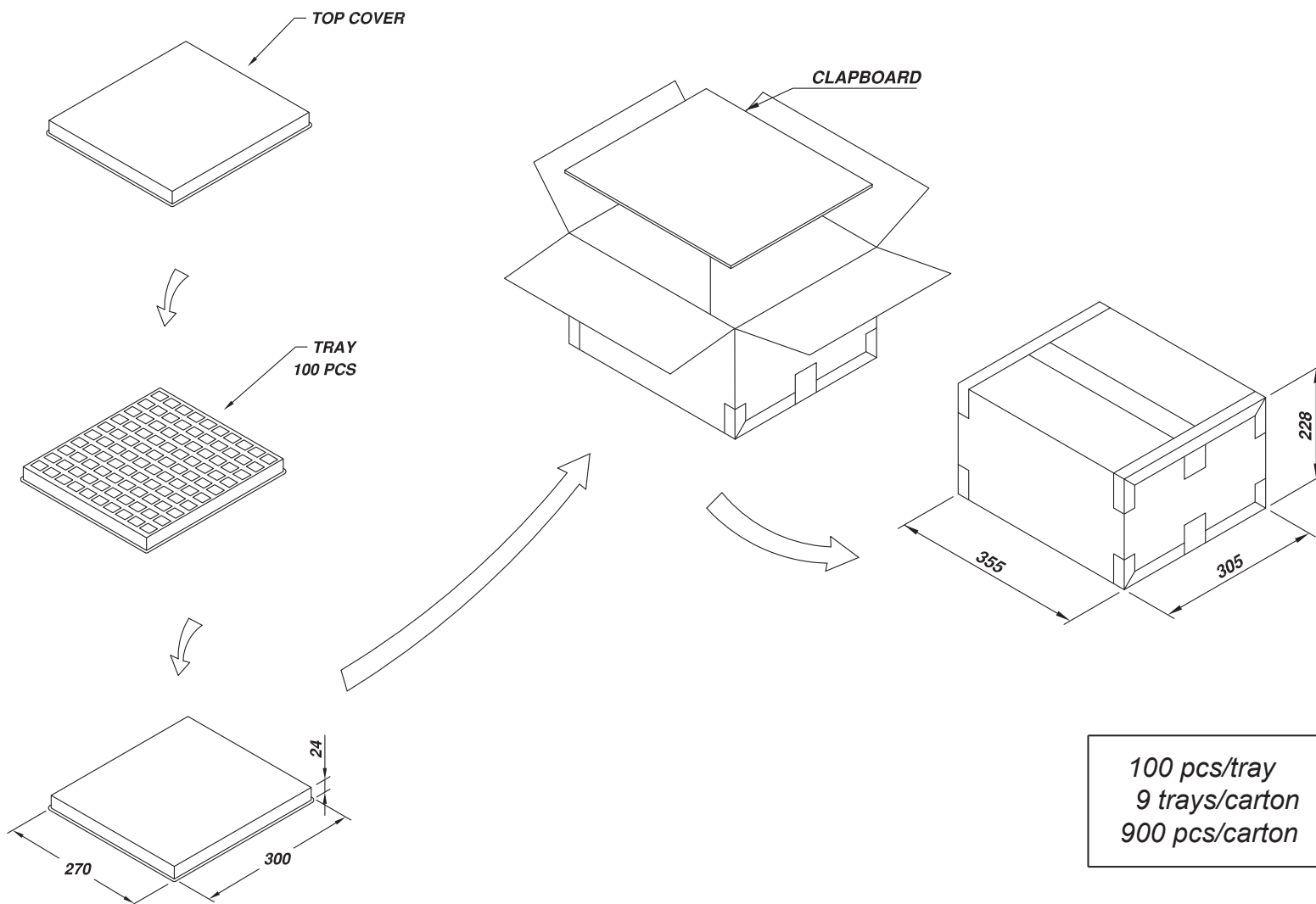

A

B

C

D

RoHS Compliant			
G			
F			
E			
D			
C			
B			
A	23-JUL-14	PDF	AS
REV	DATE	FILE	BY

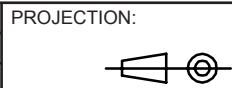

APPROVAL: RJ

GENERAL TOLERANCE
 .X = +/- 0.2
 .XX = +/- 0.15

UNIT: MM
 SCALE:
 SHEET: 2/3
 DRAW: AS



DESCRIPTION: HORIZONTAL SHIELDED SMT WITH EMI PANEL FINGER 8P8C
 WERI PART NO: 634 008 149 721

SIZE
A4

1

2

3

4

5

Cautions and Warnings:

This electronic component is designed and developed with the intention for use in general electronics equipments.

Before incorporating the components into any equipments in the field such as aerospace, aviation, nuclear control, submarine, transportation, (automotive control, train control, ship control), transportation signal, disaster prevention, medical, public information network etc. where higher safety and reliability are especially required or if there is possibility of direct damage or injury to human body, Würth Elektronik must be asked for a written approval.



In addition, even electronic component in general electronic equipments, when used in electrical circuits that require high safety, reliability functions or performance, the sufficient reliability evaluation-check for the safety must be performed before by the user before usage.

A

B

C

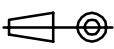
RoHS Compliant

G				PROJECTION: 	GENERAL TOLERANCE .X = +/- 0.2 .XX = +/- 0.15		
F							
E							
D							
C				APPROVAL: JC	UNIT: MM	DESCRIPTION: DISCLAIMER	SIZE A4
B					SCALE:		
A	10-SEP-14	PDF	QL		SHEET: 3/3	WERI PART NO: DISCLAIMER	
REV	DATE	FILE	BY		DRAW: QL		

D