

THIS DOCUMENT IS THE PROPERTY OF
KEYSTONE ELECTRONICS CORP. AND
SHALL NOT BE REPRODUCED, DISTRIBUTED
OR USED AS A BASIS FOR MANUFACTURE
WITHOUT PRIOR WRITTEN PERMISSION
FROM KEYSTONE ELECTRONICS CORP.

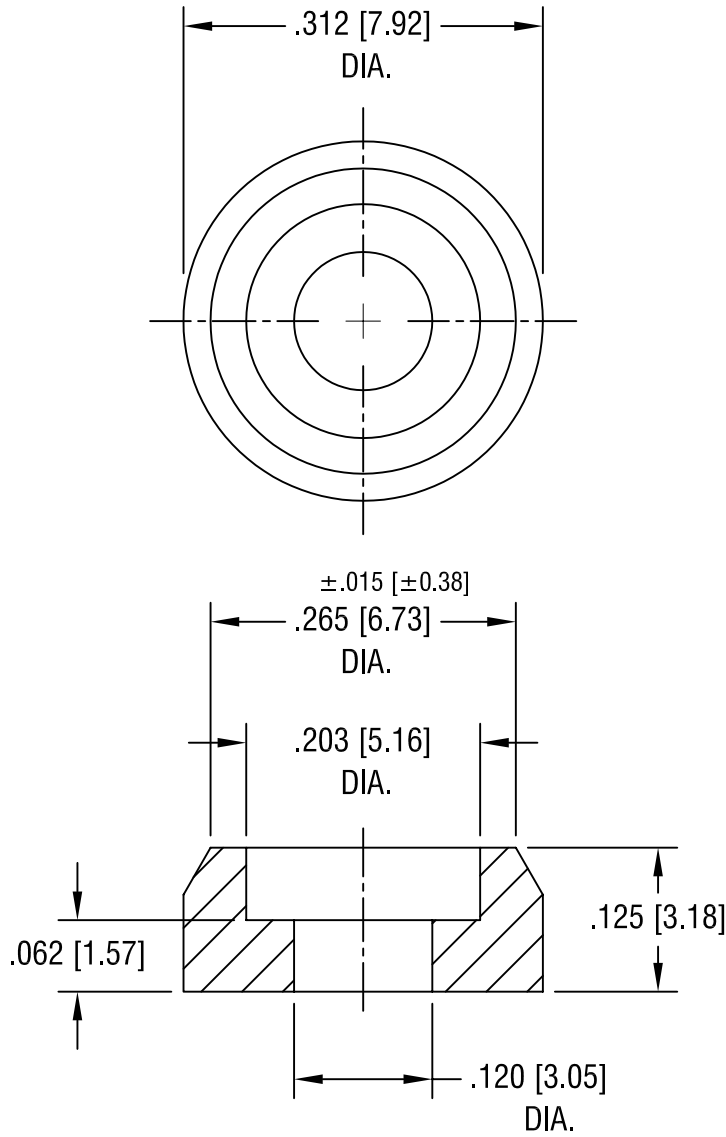

KEYSTONE ELECTRONICS CORP.

ASTORIA, N.Y. 11105-2017

PART NAME

FERRULE

MATERIAL

ALUMINUM

FINISH

BLACK ANODIZE

DRN BY

BOONE

DATE

11.28.95

APP'D

LN

SCALE

6X

9.28.07

CHANGE AS PER ECN 07-060

A

TOLERANCES

INCH [MM]

CODE

DWG NO.

DECIMAL ±.005 [±0.15]

C

ANGULAR ± 1°
UNLESS OTHERWISE SPECIFIED

9122

DATE

DESCRIPTION

REV.