



LED Module

REV.NO.

PAGE

02

1/9

SPECIFICATION

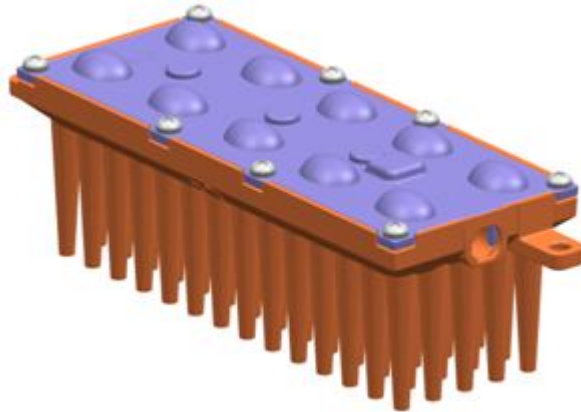

LED Module for Modular Platform Series

Model Name	LED Platform Module with Fin
Type	CRI min. 70, 4000K, Flux Rank 3, Type II-M, 351Z PKG
Parts No.	SL-P7T2E32MZWW

SAMSUNG ELECTRONICS CO., LTD.



LED Module

REV.NO.

PAGE

02

3/9

CONTENTS OF SPECIFICATION

1. APPLICATION	4
2. FUNDAMENTAL SPECIFICATIONS OF MODULE	6
3. PARTS SPECIFICATIONS	7
4. APPEARANCE AND STRUCTURE	8
5. PACKING SPECIFICATION	9

This is a product specification of [SL-P7T2E32MZWW](#), one of SL-Puv2Ewaabcc.
Please refer to relevant [General and Special Application Notes](#) for thermal, optical, electrical, mechanical design and reliability information.



LED Module

REV.NO.

PAGE

02

4/9

1. APPLICATION

Platform LED Module is designed as a core component in **Modular Platform Engine Series** for street light and flood light application. This document especially specifies **Platform LED Module with Fin**, generally recommended for luminaires with insufficient thermal management by the fixture itself.

1-1 Modular Platform Modules.

There are three different types of heat sink designs for Platform LED Module, intended for thermal management either by engine or by fixture.

This document especially specifies **Platform LED Module with Fin for thermal management by Modules or Engines themselves.**

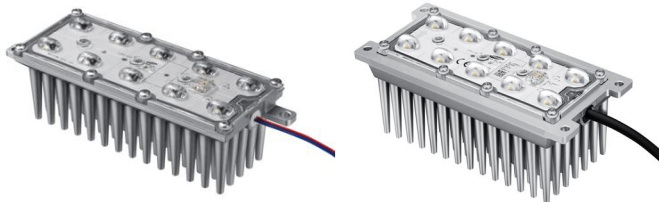

(a) Module with Fin
[Thermal management by Module/Engine]



(b) Module without Fin
[Thermal management by Fixture]

1-2 Modular Platform Engine Series

Typical operating current for one module is set at 700mA, which allows lumen output increment by **2100lm(nominal value)** depending on the number of LED modules.

1-2-1 Lumen Packages with LED Driver

Power Consumption (Engine, Nominal)	Modules (ea)	Driver Output Channels (ea)	Operating Current (mA)	Lumen Output (lm)
25W	1	1	700	2100
50W	2	1	700	4200
75W	3	1	700	6300
100W	4	2	700	8400
150W	6	2	700	12600

※ This Module is recommended using a Isolated PSU.

1-2-2 Current Distribution across Modules

Current per module can vary depending on the Vf distribution of modules in parallel, deviating from the nominal operating current(700mA). The Vf distribution of modules is tightly controlled to achieve uniform driving currents.



LED Module

REV.NO.

PAGE

02

5/9

1-2-3 Optic Solutions

Application	Light Distribution	Solutions	Material
Street Light	IESNA Type I	Medium(1)	PC
	IESNA Type II	Short(1), Medium(1), Medium(2)	PC
	IESNA Type III	Medium(1)	PC
	IESNA Type IV	Medium(1)	PC
	IESNA Type V	Short(1)	PC
Flood Light	Medium	Batwing(BA85)	PC

※ BA : Beam Angle, PC : Polycarbonate



LED Module

REV.NO.	PAGE
02	6/9

2. FUNDAMENTAL SPECIFICATIONS OF MODULE

No.	ARTICLE	SPECIFICATIONS					
2-1	Photometric Specification of Platform LED Module @700mA(stabilized at Tc~65°C)						
	CCT	Article					
		Symbol					
		MIN					
	TYP	MAX					
	Unit	Equipments					
4000K	Luminous Flux	LF	1950	2100	-	lm	Goniometer
	Color Temperature	CCT	3650	3900	4200	K	Integrating Sphere
	Color Rendering Index	CRI	70	-	-	Ra	Integrating Sphere
		※ Typical values are not necessarily the same as the nominal values.					
		Light Distribution Profile : Type II Medium(1) with Optimized Illuminance Uniformity					
		※ The isolux diagram is drawn at the luminaire height of 5m. ※ IES files(in IESNA or CIE format) are available with Optical Application Notes .					
2-2	Dimension	• LED Module with Fin : 150(L)×50(W)×45.02(H) mm					
2-3	Weight	• LED Lighting Module : {0.28kg ± 0.03kg} * 12ea • Total Weight (including packing box) : 4.8kg ± 0.5kg/1box					
2-4	Operating Temperature	• Case Temperature : +10°C ~ +80°C (Tc ~ 65°C at Ta ~ 25°C) ※ Recommended Tc points as a function of number of modules are described in Thermal Application Notes .					
2-5	Storage Temperature	• -30°C ~ +70°C (Tc) ※ Ambient temperature without operation					
2-6	Dust-proof Water-proof	• IP66 for CE Marking • Damp Location for UL Marking					



LED Module

REV.NO.

PAGE

02

7/9

No.	ARTICLE	SPECIFICATIONS					
2-7	Electrical Specification of Platform LED Module @700mA (stabilized at Tc~65°C)						
	Article	Symbol	MIN	TYP	MAX	Unit	Remarks
	Power Consumption	P	-	21	25	W	30V x 0.7A, module only
	DC Forward Current	I	-	700	700	mA	per 1 Module [700mA /PKG 1EA,TYP.]
	Forward Voltage	Vf	26.0	30.0	33.0	V	per 1 Module [3.0V/PKG 1EA, TYP.] 10 LEDs in Series
	Type Classification	· Built-in module 					
	Eye Protection	· Risk Group 2					
	Working Voltage for Insulation	· 50V					
<p>※ The power consumption for a specific module is dependent on the operating voltage distribution across the modules in parallel connection. The maximum operating current means the highest limit in any operating condition.</p> <p>※ Typical and Maximum Operating Current may have ±5% Tolerance</p> <p>※ Voltage difference between modules are tightly controlled to be less than 1.0V so that the maximum current of any module can be limited to 700mA. Voltage bins of modules will be designated on the module label and box label.</p> <p>※ Safety and wiring information will be described in Electrical Application Notes.</p> <p>※ We recommend users to attach the surge protector to a PSU or to use a PSU that equipped surge protect circuit suitable for the user's atmosphere condition.</p>							

3. PARTS SPECIFICATIONS

No.	ARTICLE	SPECIFICATIONS
3-1	Lens Cover Screw	<ul style="list-style-type: none"> Material : Stainless Steel with Teflon Washer Location : between the array lens and heat sink
3-2	Array Lens Cover	<ul style="list-style-type: none"> Material : Polycarbonate Thickness : 2.0 mm Lens Type : Type II-M(1) UL-94 Flammability : V-2 ※ Protective Equipment in Luminaries needs to prevent flaming drips.
3-3	Seal Rubber	<ul style="list-style-type: none"> Material : Molded Silicone
3-4	LED Board	<ul style="list-style-type: none"> LED : Ceramic PKG, CCT 4000K, CRI min. 70 Material : MCPCB, Aluminum Thickness : 1.6 mm Stainless Steel Screws : 3ea
3-5	Side Inlet Harness	<ul style="list-style-type: none"> Material : Molded PVC coated with Sealant Silicone, 105°C rating Wires : 24 AWG, 105°C rating Length(wires) : 550 mm
3-6	Heat Sink (with Fin)	<ul style="list-style-type: none"> Material : Die-cast Aluminium Thermal Pad between the PCB and Heat Sink



LED Module



REV.NO.

PAGE

02

8/9

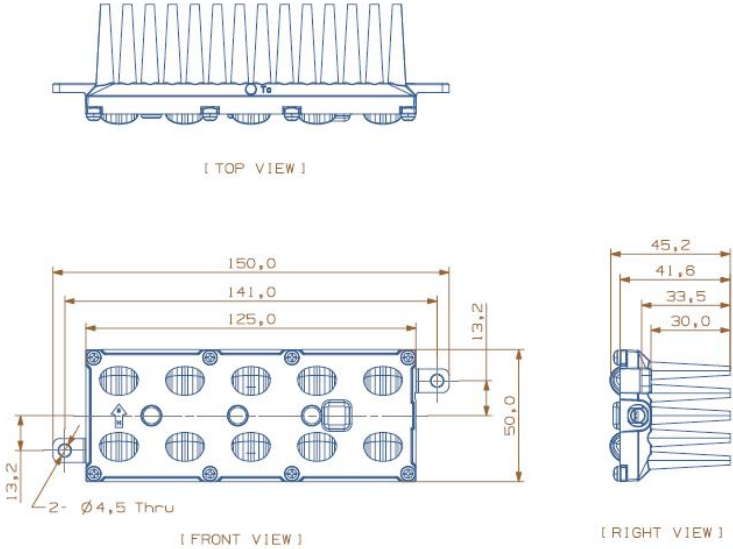
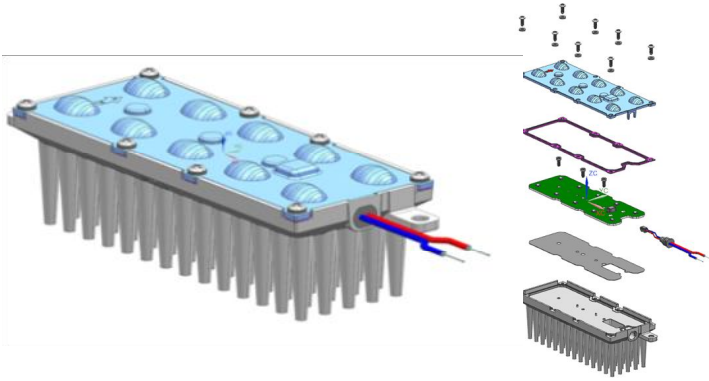
4. APPEARANCE AND STRUCTURE

No.	ARTICLE	SPECIFICATIONS
4-1	Appearance and Dimension (Type II-M(1))	 <p>※ Appearance is different for various optical solutions depending on the combination of the 10 core lenses. Critical dimensions are all the same for the optical solutions except for the thickness difference at the core lens cross-section. Detailed information on the lenses are described in Optical and Mechanical Application Notes.</p>
4-2	Structure (Type II-M(1))	
4-3	Labelling for Vf Binning (General)	 <p>[LED Board Label] [Module Label] [Box Label]</p>



LED Module

REV.NO.

PAGE

02

9/9

5. PACKING SPECIFICATION

5-1 Packing Method

5-1-1 Inner Box : 6 modules of the same Vf bin in one inner box

6 PCs/Inner Box



5-1-2 Outer Box : 12 modules on 2 stacks of inner boxes in one outer box

2 Stacks of Inner Boxes
(419 x 240 x 189)



5-2 Pallet : 32 boxes(384 modules) on one pallet

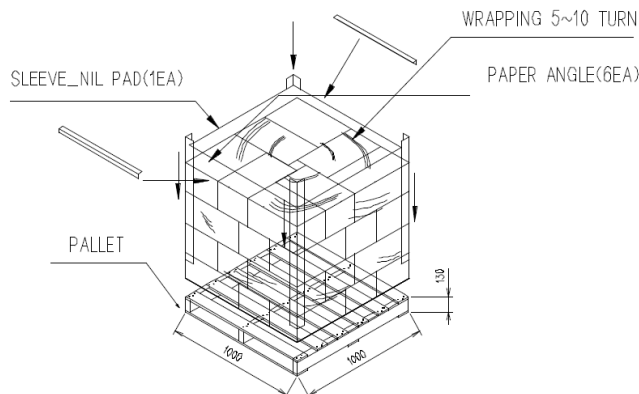

※ Two stacks of pallets are allowed.