

HIGH-SPEED OPERATIONAL AMPLIFIER

■ GENERAL DESCRIPTION

The NJM318 is a precision high-speed operational amplifier, which designed for applications requiring wide bandwidth and high slew rate. They feature a factor of ten increases in speed over general purpose devices without sacrificing DC performance.

The NJM318 has internal unity gain frequency compensation. This considerably simplifies its application since no external components are necessary for operation. However, unlike most internally compensated amplifiers, external frequency compensation may be added for optimum performance. For inverting applications, feedforward compensation will boost the slew rate to over 150V/μs and almost double the bandwidth. Overcompensation can be used with the amplifier for greater stability when maximum bandwidth is not needed. Further, a single capacitor can be added to reduce the 0.1% setting time to under 1μs.

The high speed and fast setting time of these op amps make them useful in A/D converters, oscillators, active filters, sample and hold circuits, or general purpose amplifiers. These devices are easy to apply and offer an order of magnitude better AC performance than industry standards such as the NJM741.

■ PACKAGE OUTLINE

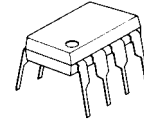

NJM318D

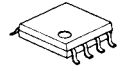

NJM318M

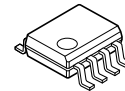

NJM318E

■ FEATURES

- Operating Voltage (±5V~±20V)
- Wide Unity Gain Bandwidth (15MHz typ.)
- High Slew Rate (70V/μs typ.)
- Package Outline DIP8,DMP8,SOP8 JEDEC 150mil
- Bipolar Technology

■ PIN CONFIGURATION

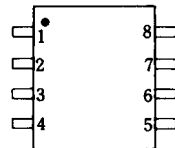

NJM318D
NJM318M

PIN FUNCTION

1. BAL/COMP1
2. -INPUT
3. +INPUT
4. V⁻
5. BAL/COMP3
6. OUTPUT
7. V⁺
8. COMP2

■ EQUIVALENT CIRCUIT

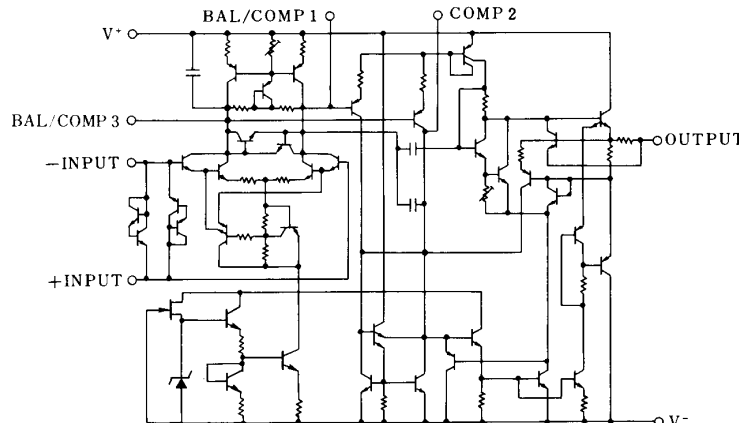

NJM318

■ ABSOLUTE MAXIMUM RATINGS

(Ta=25°C)

PARAMETER	SYMBOL	RATINGS	UNIT
Supply Voltage	V^+ / V^-	± 20	V
Differential Input Current (note1)	I_{ID}	± 10	mA
Input Voltage (note2)	V_{IC}	± 15	V
Power Dissipation	P_D	(DIP8) 500 (DMP8) 300 (SOP8) 300	mW
Operating Temperature Range	T_{opr}	-40~+85	°C
Storage Temperature Range	T_{stg}	-40~+125	°C

(note1) A current limiting resistance is required when the input voltage is higher than 1V.

(note2) For supply voltage less than ±15V, the absolute maximum input voltage is equal to the supply voltage.

■ ELECTRICAL CHARACTERISTICS

(Ta=+25°C, $V^+ / V^- = \pm 15V$)

PARAMETER	SYMBOL	TEST CONDITION	MIN.	TYP.	MAX.	UNIT
Input Offset Voltage	V_{IO}		-	4	10	mV
Input Offset Current	I_{IO}		-	30	200	nA
Input Bias Current	I_{IB}		-	150	500	nA
Input Resistance	R_{IN}		0.5	-	-	MΩ
Operating Current	I_{CC}		-	5	10	mA
Large Signal Voltage Gain	A_V	$R_L \geq 2k\Omega, V_O = \pm 10V$	88	106	-	dB
Slew Rate	SR	$A_V = 1, R_S = 10k\Omega$	50	70	-	V/μs
Unity Gain Bandwidth	f_T		-	15	-	MHz
Input Common Mode Voltage Range	V_{ICM}		± 11.5	-	-	V
Common Mode Rejection Ratio	CMR		70	100	-	dB
Supply Voltage Rejection Ratio	SVR		65	80	-	dB
Output Voltage Swing	V_{OM}	$R_L = 2k\Omega$	± 12	± 13	-	V

■ TYPICAL CHARACTERISTICS

Input Bias Current, Input Offset Current vs. Temperature

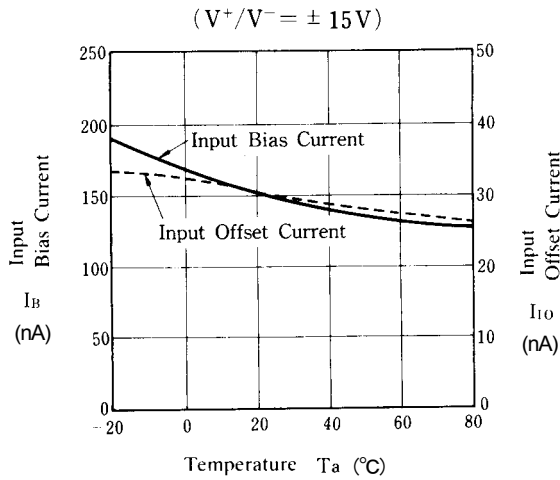

Voltage Gain vs. Operating Voltage

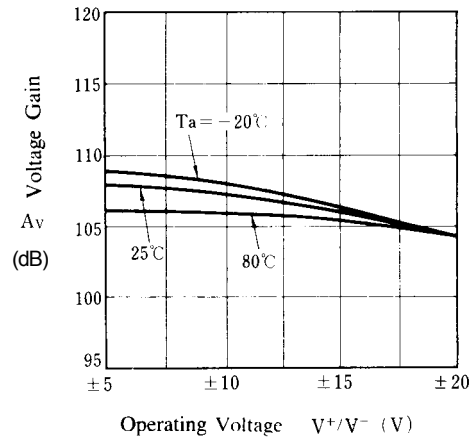

Supply Voltage Rejection vs. Frequency

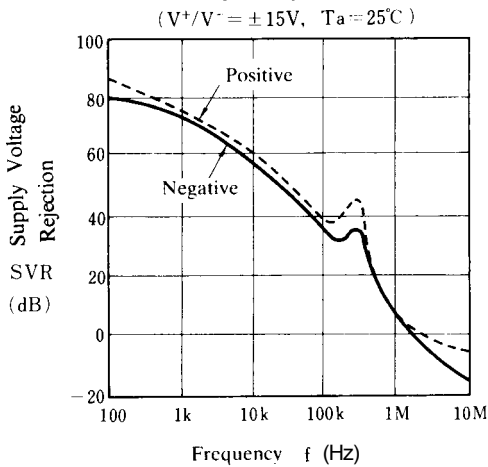

Common Mode Rejection vs. Frequency

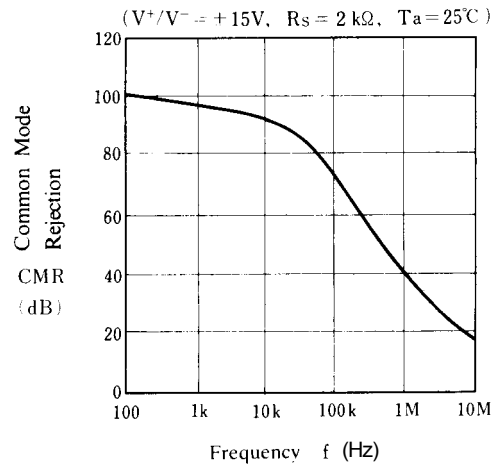

Current Limiting

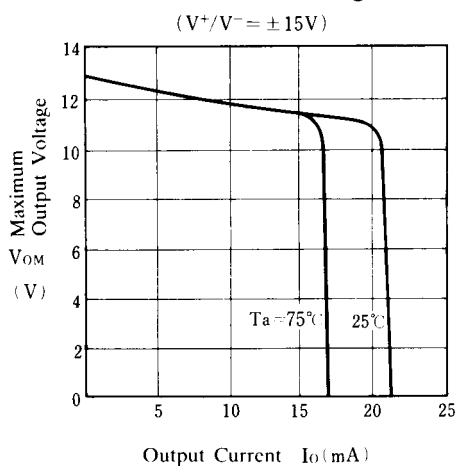

Differential Input Current vs. Differential Input Voltage

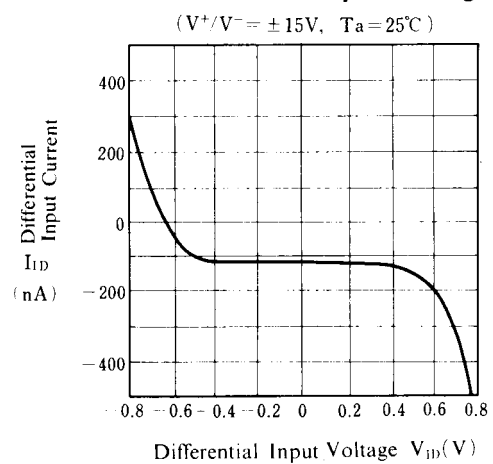

■ TYPICAL CHARACTERISTICS

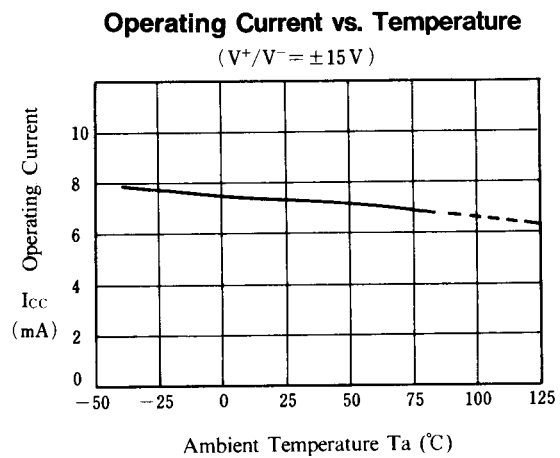
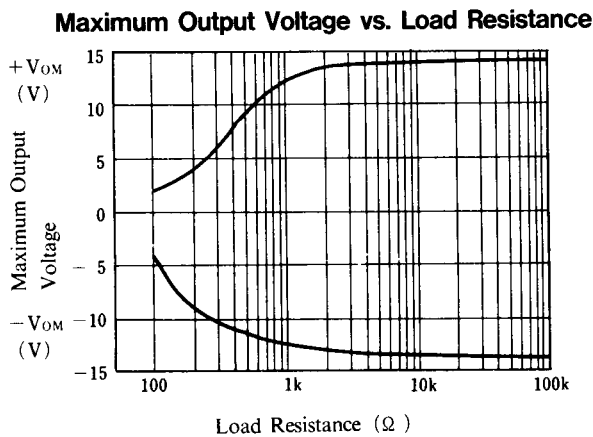
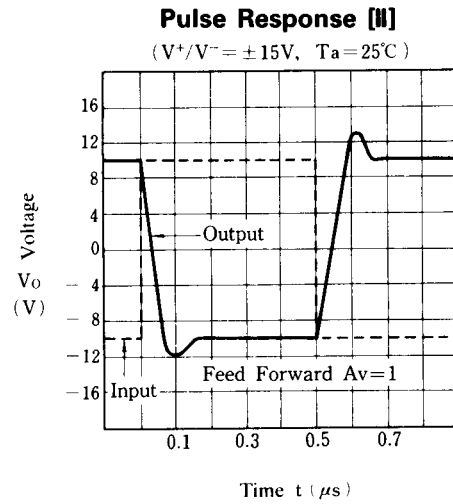
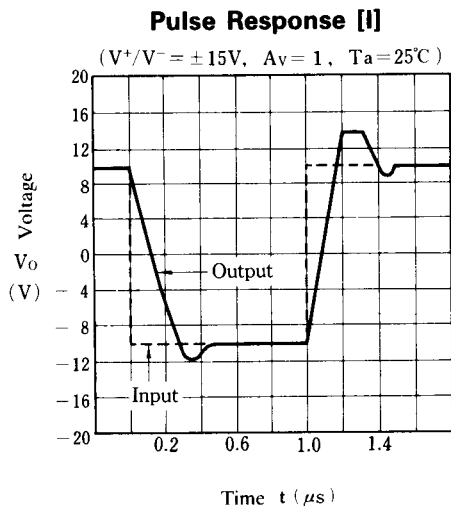
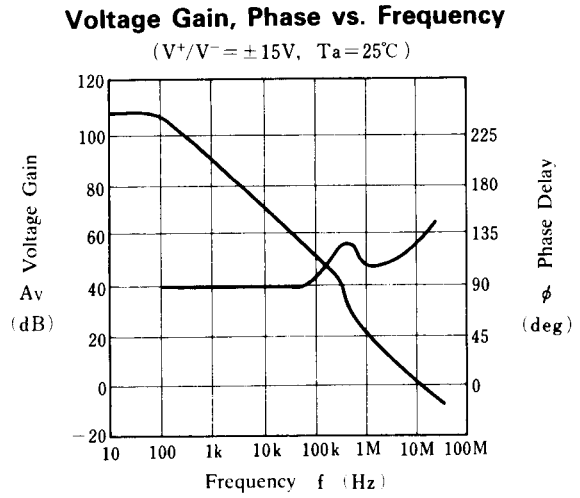
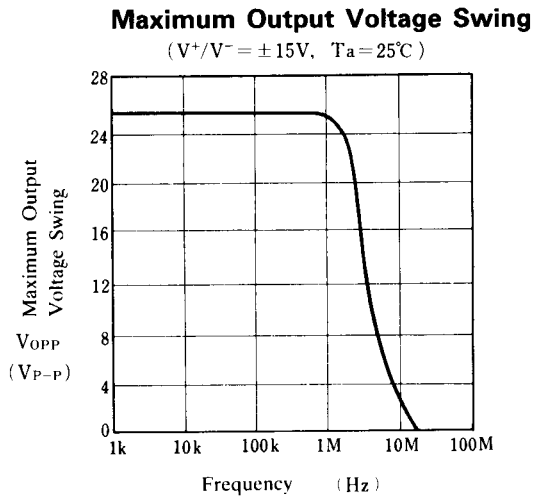

■ TYPICAL CHARACTERISTICS

Maximum Output Voltage vs. Temperature

($V^+/V^- = \pm 15\text{ V}$, $R_L = 2\text{ k}\Omega$)

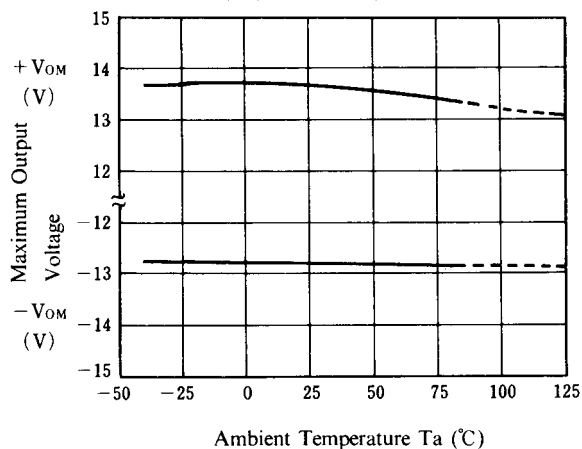

Input Bias Current vs. Temperature

($V^+/V^- = \pm 15\text{ V}$)

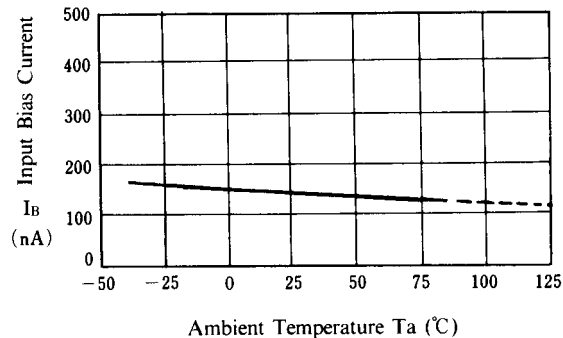

Input Offset Voltage vs. Temperature

($V^+/V^- = \pm 15\text{ V}$)

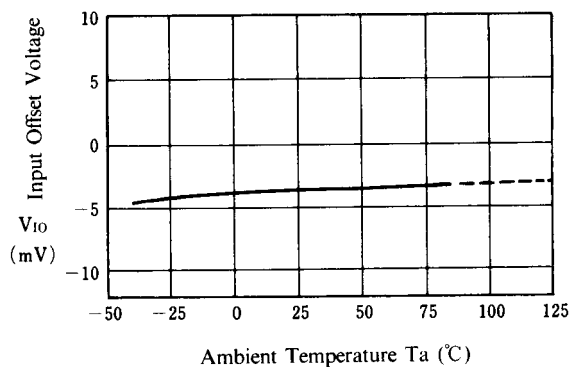

■ ADJUSTMENT METHOD

○ offset Adjustment

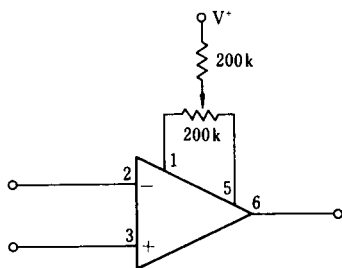

○ Feedforward Compensation

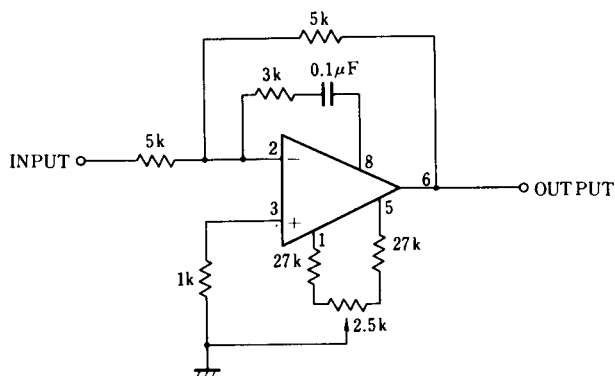

[CAUTION]

The specifications on this databook are only given for information, without any guarantee as regards either mistakes or omissions. The application circuits in this databook are described only to show representative usages of the product and not intended for the guarantee or permission of any right including the industrial rights.