

REVISIONS					
P	LTR	DESCRIPTION	DATE	DWN	APVD
B	I	REVISED PER ECR-10-019377	30SEP2010	HMR	T.M
C		REVISED PER ECR-14-000206	26DEC2013	DR	RB

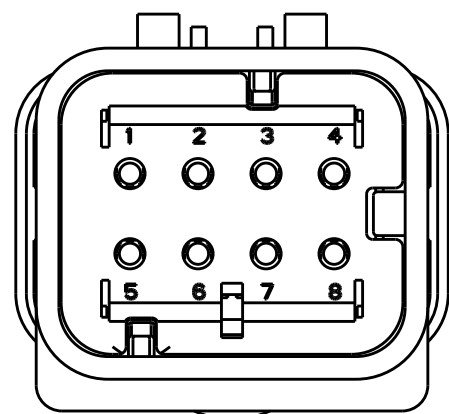

1717676-2
SCALE 2:1

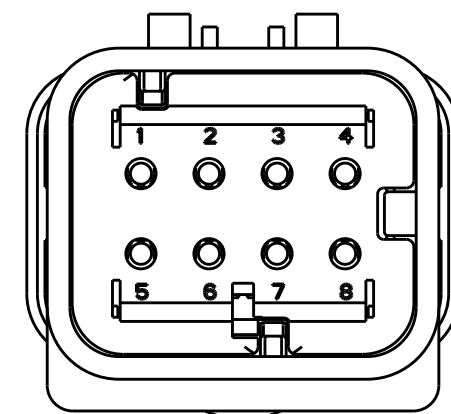

1717676-3
SCALE 2:1

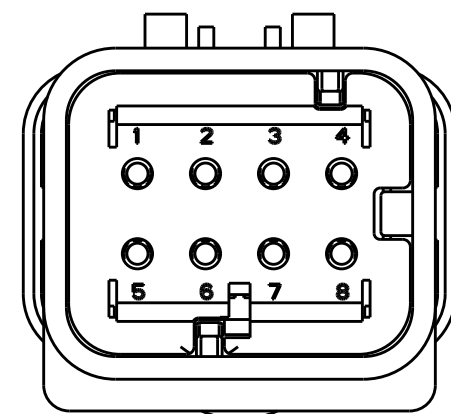

1717676-4
SCALE 2:1

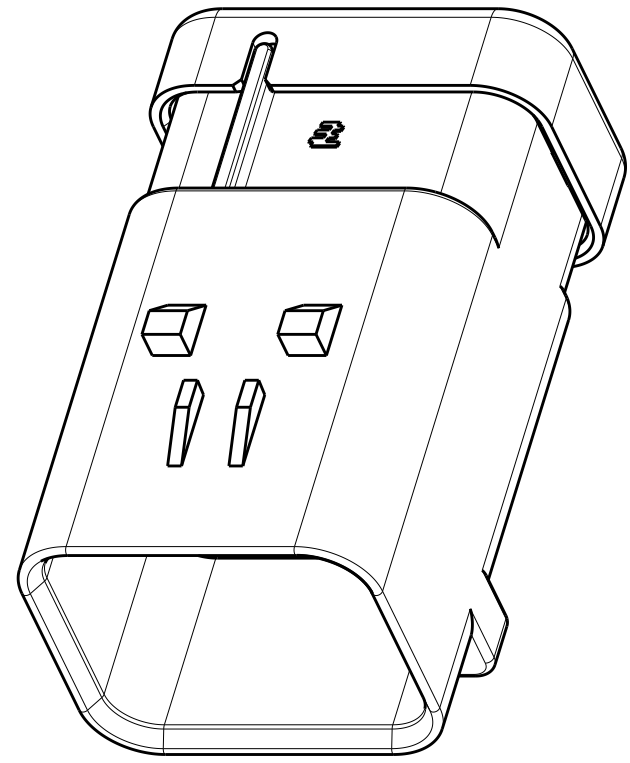

SCALE 2:1

- ① MATERIAL: 15% GLASS FILLED THERMOPLASTIC
COLOR: BLACK
- ② MATERIAL: 15% GLASS FILLED THERMOPLASTIC
COLOR: (SEE TABLE)
- ③ MATERIAL: SILICONE
COLOR: GREEN

4. WIRE INSULATION RANGE: $\varnothing 2.24 \sim \varnothing 3.94$

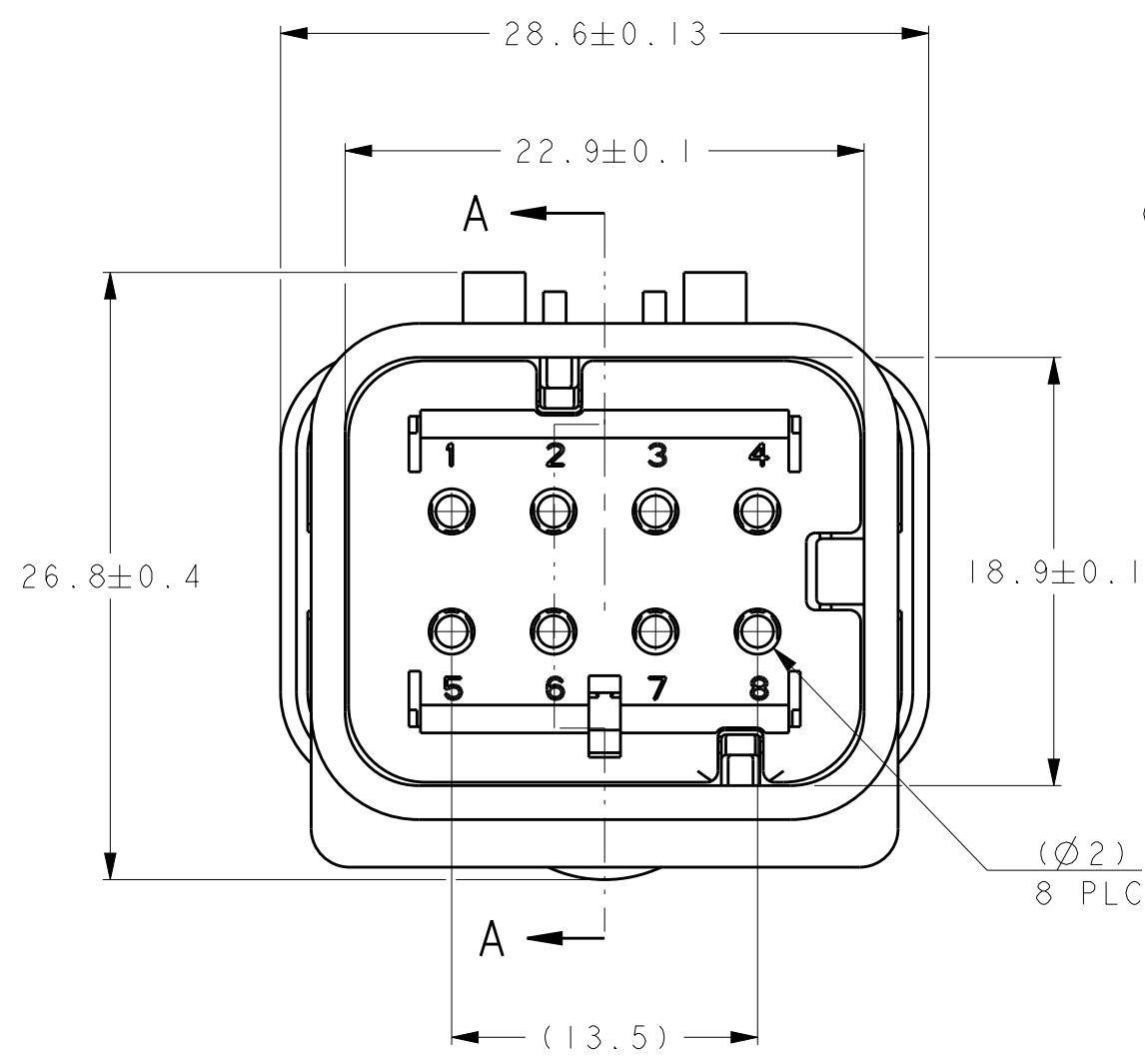

1717676-1 SHOWN

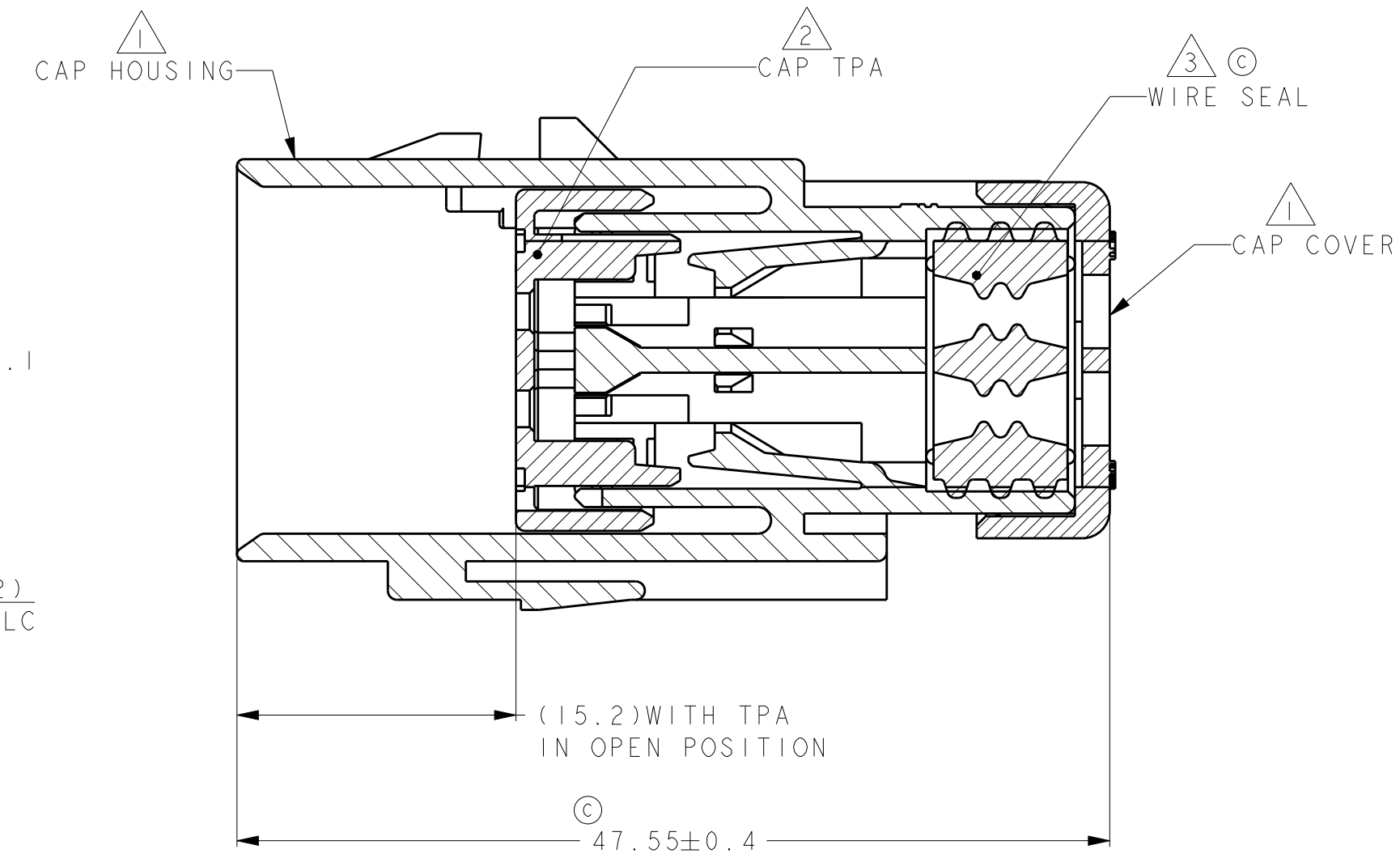

A - A
OPEN POSITION

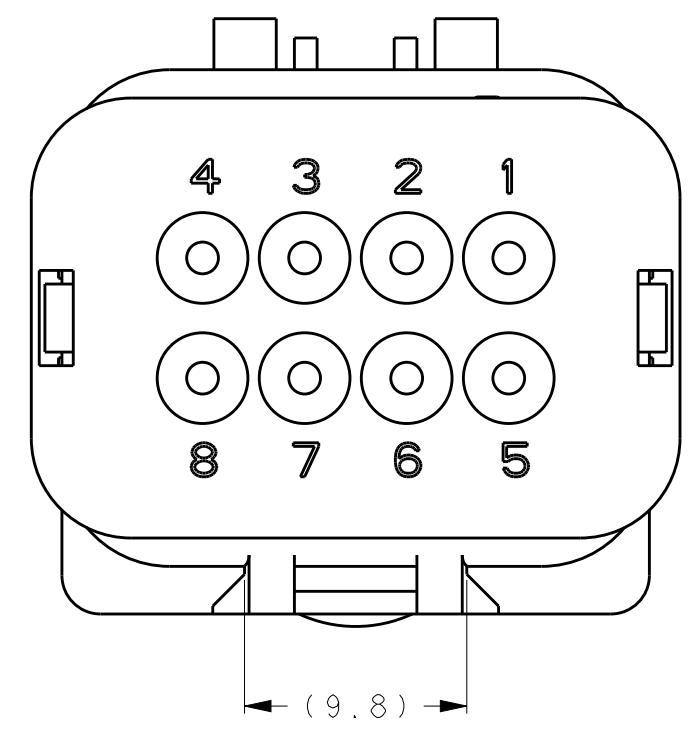

GREEN	1717676-4
YELLOW	1717676-3
GRAY	1717676-2
RED	1717676-1
TPA COLOR	PART NUMBER

THIS DRAWING IS A CONTROLLED DOCUMENT.		DWN Y. KATO 15JAN2004	TE Connectivity
DIMENSIONS: mm		CHK S. MANABE 15JAN2004	
TOLERANCES UNLESS OTHERWISE SPECIFIED:		APVD S. MANABE 15JAN2004	
0 PLC ± 1 PLC ±0.5 2 PLC ±0.13 3 PLC ±0.013 4 PLC ±0.0001 ANGLES ± FINISH -		PRODUCT SPEC 108-2184 APPLICATION SPEC 114-13065 WEIGHT -	
MATERIAL TBD		CUSTOMER DRAWING	NAME CAP ASSY, 8 POS. BRACKET REVERSE TYPE AMP SEAL 16 SIZE CAGE CODE DRAWING NO RESTRICTED TO A200779 C-1717676 SCALE 3:1 SHEET 1 OF 1 REV C