



ENGINEERING PRODUCT SPECIFICATION

DATE ISSUED: 12/07/2011

CCS-11005

Page 1 of 10

SUBJECT / TITLE :

UNIVERSAL CONTACT Z SERIES

1 The Products Summary

The Universal Contact Z series comprises of a metal beam manufactured using a Titanium Copper alloy. The beam is formed up into a protective box provided by the two side wings, which guide the beam within its operating stroke. These side wings are also used to maintain pre-load to the beam in its unmated condition. The contact point of the beam incorporates a 'domed' surface to maintain a high 'hertz stress' contact and good contact resistance.

Height	P/N	Description	Material
1.3mm	120220-0310	Universal Contact Z 1.3mm	Titanium Copper alloy
1.6mm	120220-0331	Universal Contact Z 1.6mm	Titanium Copper alloy
1.8mm	120220-0311	Universal Contact Z 1.8mm	Titanium Copper alloy
2.5mm	120220-0312	Universal Contact Z 2.5mm	Titanium Copper alloy
3.0mm	120220-0313	Universal Contact Z 3.0mm	Titanium Copper alloy
3.5mm	120220-0314	Universal Contact Z 3.5mm	Titanium Copper alloy
4.0mm	120220-0315	Universal Contact Z 4.0mm	Titanium Copper alloy

ECR/ECO NUMBER	R1E-1778	ECR-00249				
REVISED BY:	Bills.Liu	Bills.Liu				
DATE	2006/6/19	2012/08/16				
REVISION	A	B				

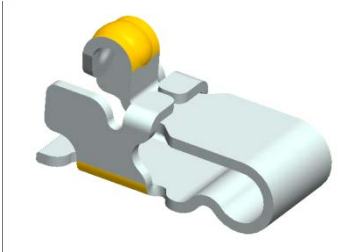
2 The Picture of the products
2.1 UCZ 1.3mm

120220-0310

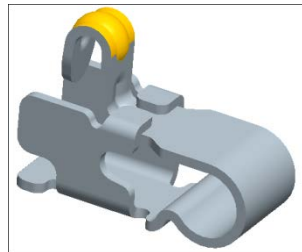
2.2 UCZ 1.8mm

120220-0311

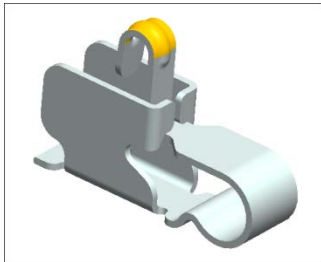
2.3 UCZ 2.5mm

120220-0312

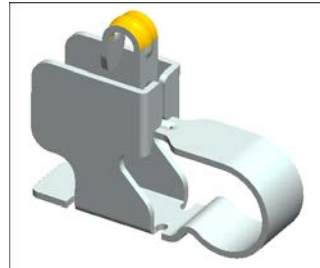
2.4 UCZ 3.0mm

120220-0313

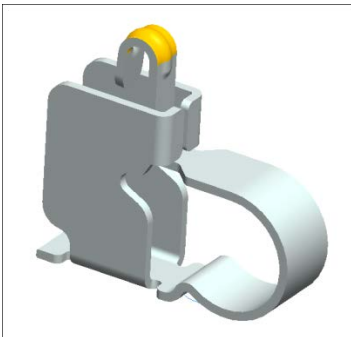
2.5 UCZ 3.5mm

120220-0314

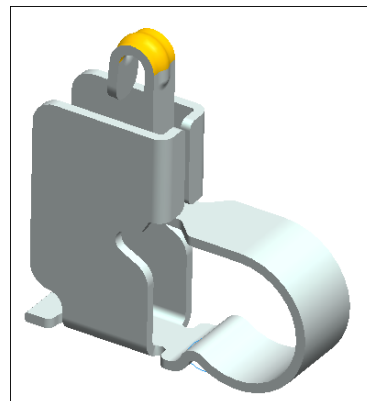
2.6 UCZ 4.0mm

120220-0315

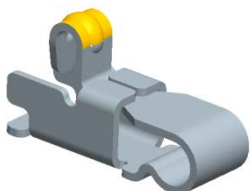
2.7 UCZ 1.6mm

120220-0331



**ENGINEERING PRODUCT
SPECIFICATION**

DATE ISSUED: 12/07/2011

CCS-11005

Page 3 of 10

SUBJECT / TITLE :

UNIVERSAL CONTACT Z SERIES

3 Explanation of application

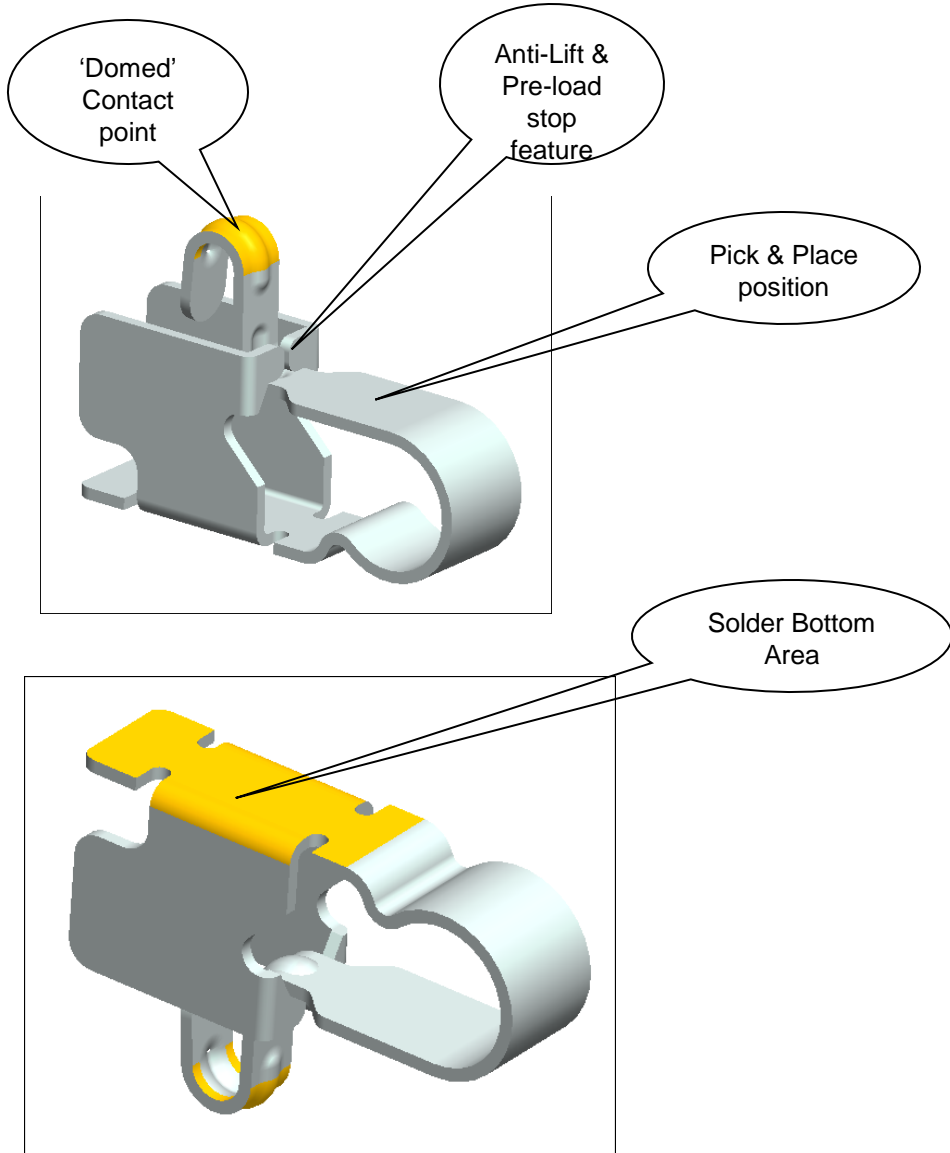

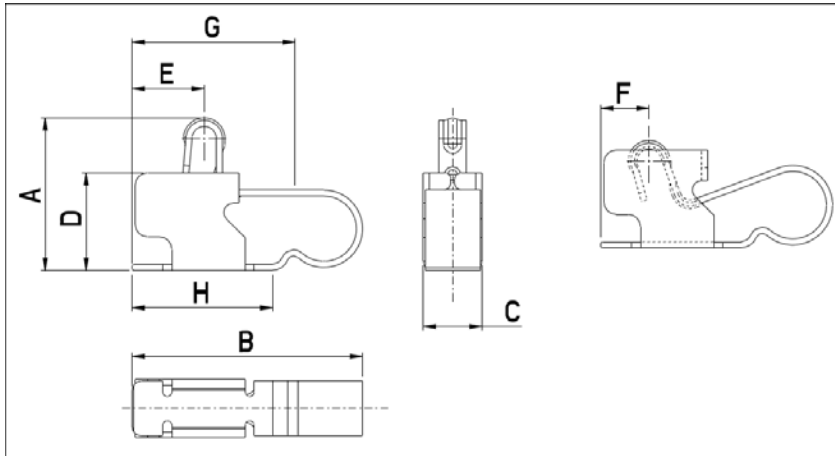
4 Dimensions
4.1 dimension Contact

Height	P/N	Dimensions (mm)								Operating Height
		A	B	C	D	E	F	G	H	
1.3mm	120220-0310	1.30	2.37	0.96	0.80	0.49	0.35	1.61	1.39	0.9-1.2
1.8mm	120220-0311	1.80	2.50	0.96	1.00	0.56	0.27	1.82	1.46	1.1-1.7
1.6mm	120220-0331	2.10	2.92	0.96	0.90	0.74	0.57	2.25	1.96	0.9-1.6
2.5mm	120220-0312	2.50	3.66	0.96	1.60	1.35	0.83	2.66	2.30	1.6-2.4
3.0mm	120220-0313	3.00	3.73	0.96	2.20	1.37	0.73	2.68	2.30	2.2-2.9
3.5mm	120220-0314	3.50	3.79	0.96	2.60	1.22	0.41	2.43	1.95	2.6-3.4
4.0mm	120220-0315	4.00	3.99	0.96	3.00	1.27	0.36	2.43	2.15	3.0-3.9

4.2 Recommended PCB layout

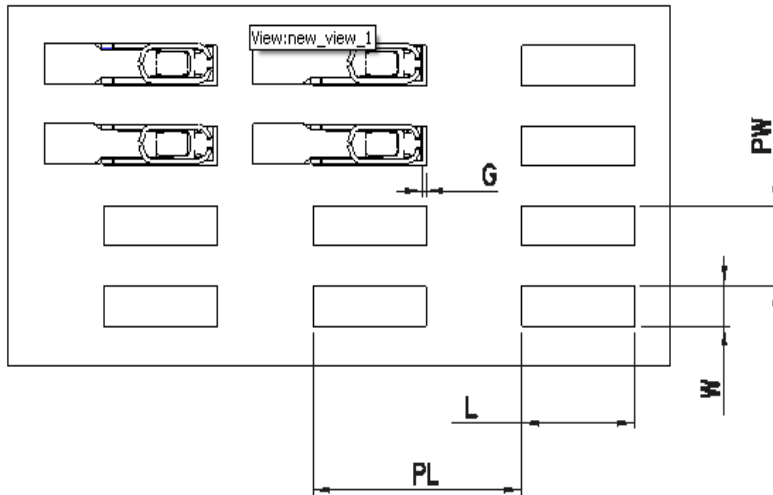

Height	P/N	Dimensions (mm)				
		L	W	PL	PW	G
1.3mm	120220-0310	1.39	1.00	2.87	1.50	0.10
1.6mm	120220-0331	1.96	1.00	3.42	1.50	0.10
1.8mm	120220-0311	1.46	1.00	2.90	1.50	0.10
2.5mm	120220-0312	2.30	1.00	4.16	1.50	0.10
3.0mm	120220-0313	2.30	1.00	4.23	1.50	0.10
3.5mm	120220-0314	1.95	1.00	4.29	1.50	0.10
4.0mm	120220-0315	2.15	1.00	4.49	1.50	0.10

4.3 Recommended soldering pad thickness : 0.1 mm



**ENGINEERING PRODUCT
SPECIFICATION**

DATE ISSUED: 12/07/2011

CCS-11005

Page 6 of 10

SUBJECT / TITLE :

UNIVERSAL CONTACT Z SERIES

5 Material and Finish

5.1 Plating on contact position: 1.0 um Au over 1.0/3.0 um Ni.

Height	P/N	Plating on contact position	Plating on soldering position
1.3mm	120220-0310	1.0 um Au over 1.0/3.0 um Ni.	0.05/0.15 um Au over 1.0/3.0 um Ni
1.8mm	120220-0311		
2.5mm	120220-0312		
3.0mm	120220-0313		
3.5mm	120220-0314		
4.0mm	120220-0315		



ENGINEERING PRODUCT SPECIFICATION

DATE ISSUED: 12/07/2011

CCS-11005

Page 7 of 10

SUBJECT / TITLE :

UNIVERSAL CONTACT Z SERIES

6 Mechanical

6.1 Mechanical Performance--Force/Deflection

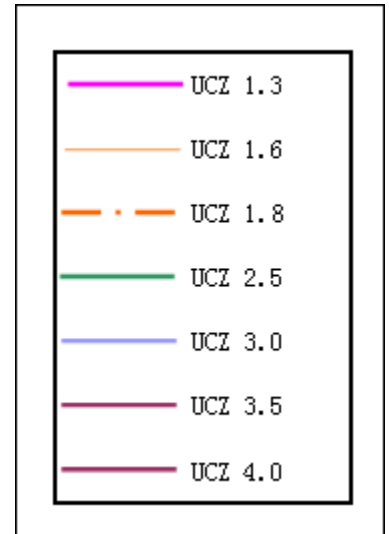
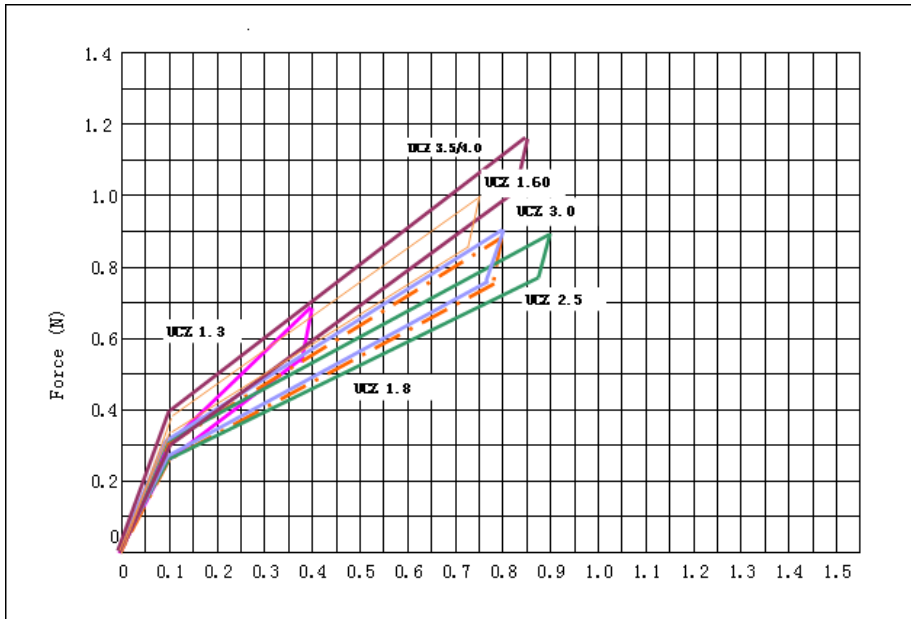

Mechanical Performance (All force data after 3x Reflow at 260° C)

Height	P/N	Pre-Load Applying Load (N)	Pre-Load Un-Applying Load (N)	Max Deflection(mm) --Min tolerance conditions	Mating Force @ Max Deflection (N)	Spring Rate (N/mm)
1.3mm	120220-0310	0.35	0.28	0.40	0.80	1.12
1.6mm	120220-0331	0.43	0.38	0.70	1.00	0.88
1.8mm	120220-0311	0.35	0.26	0.80	0.88	0.55
2.5mm	120220-0312	0.36	0.32	0.90	0.78	0.48
3.0mm	120220-0313	0.35	0.32	0.80	0.78	0.48
3.5mm	120220-0314	0.40	0.36	0.90	0.72	0.72
4.6mm	120220-0315	0.40	0.36	0.90	0.72	0.72



ENGINEERING PRODUCT SPECIFICATION

DATE ISSUED: 12/07/2011

CCS-11005

Page 8 of 10

SUBJECT / TITLE :

UNIVERSAL CONTACT Z SERIES

6.2 Durability---Mating Cycles: 100 min. Up to and over 500 cycles may be achieved depending on mating surface. Maximum mating cycle based on mating PCB plated with 0.05 μ Au over 2.0 μ Ni = 500 cycles.

(Wear resistance is subject to mating component surface finish and plating type, increased mating component plating spec = increased mating cycles.)

6.3 Vibration---The test samples were subjected to the following vibration profile:

5Hz to 9Hz @ 1.5mm pk Displacement
9Hz to 200Hz @ 0.5g pk Acceleration
1 Oct per minute; 1 Hour per axis. 3 Axis total.

6.4 Shock ---The test samples were subjected to the following shock:

100g pk Acceleration
11ms duration
3 shocks in each axis
6 directions

7 Electrical

7.1 Contact Resistance: Max 20 m Ω

7.2 Current:

Rating current : 1.50A
Max. continual current : 2.0 A
Peak current : 2.5 A

8 Environmental

8.1 Operating Temperature: Usable in temperatures between -40 and +85° C.

8.2 Humidity: Operable in 90% Relative Humidity (Temperature <40° C).

8.3 Lower Temperature : -57° C(24hours) followed by-51° C(48hours)

8.4 High temperature: +85° C(24hours) followed by 71° C(144hours)

8.3 Solder Systems: Suitable for lead free reflow soldering at 260° C. Max. 3 x reflow cycles recommended. According to JEDEC Standard J-STD-020C

Hand Soldering
Wave line Soldering
Infrared Reflow Soldering

Table 5-2 Classification Reflow Profiles

Profile Feature	Sn-Pb Eutectic Assembly	Pb-Free Assembly
Average Ramp-Up Rate (Ts _{max} to Tp)	3 °C/second max.	3° C/second max.
Preheat – Temperature Min (Ts _{min}) – Temperature Max (Ts _{max}) – Time (ts _{min} to ts _{max})	100 °C 150 °C 60-120 seconds	150 °C 200 °C 60-180 seconds
Time maintained above: – Temperature (T _L) – Time (t _L)	183 °C 60-150 seconds	217 °C 60-150 seconds
Peak/Classification Temperature (Tp)	See Table 4.1	See Table 4.2
Time within 5 °C of actual Peak Temperature (tp)	10-30 seconds	20-40 seconds
Ramp-Down Rate	6 °C/second max.	6 °C/second max.
Time 25 °C to Peak Temperature	6 minutes max.	8 minutes max.

Note 1: All temperatures refer to topside of the package, measured on the package body surface.

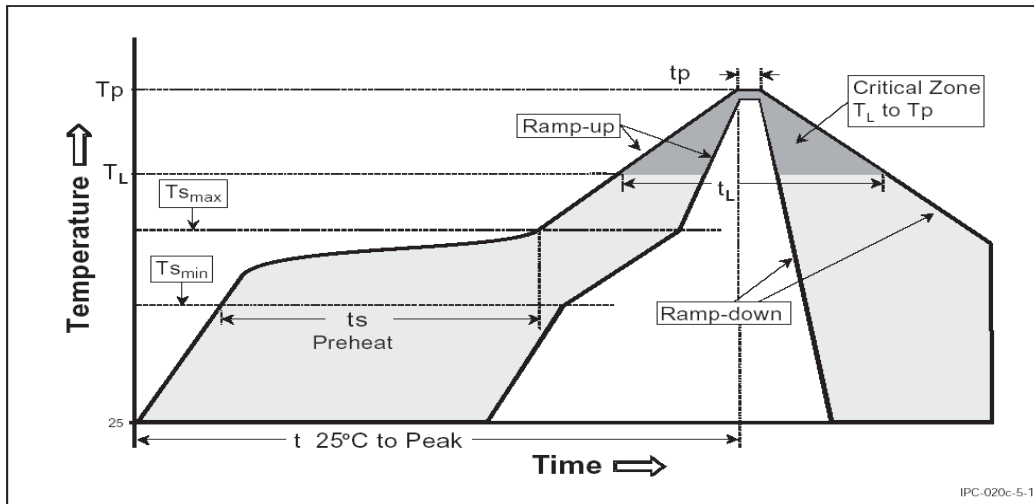

Figure 5-1 Classification Reflow Profile

Table 4-1 SnPb Eutectic Process – Package Peak Reflow Temperatures

Package Thickness	Volume mm ³ <350	Volume mm ³ ≥ 350
<2.5 mm	240 +0/-5 °C	225 +0/-5°C
≥ 2.5 mm	225 +0/-5°C	225 +0/-5°C

Table 4-2 Pb-free Process – Package Classification Reflow Temperatures

Package Thickness	Volume mm ³ <350	Volume mm ³ 350 - 2000	Volume mm ³ >2000
<1.6 mm	260 +0 °C *	260 +0 °C *	260 +0 °C *
1.6 mm - 2.5 mm	260 +0 °C *	250 +0 °C *	245 +0 °C *
≥2.5 mm	250 +0 °C *	245 +0 °C *	245 +0 °C *

* Tolerance: The device manufacturer/supplier shall assure process compatibility up to and including the stated classification temperature (this means Peak reflow temperature +0 °C. For example 260 °C+0°C) at the rated MSL level.

Note 1: The profiling tolerance is + 0 °C, -X °C (based on machine variation capability) whatever is required to control the profile process but at no time will it exceed - 5 °C. The producer assures process compatibility at the peak reflow profile temperatures defined in Table 4.2.

Note 2: Package volume excludes external terminals (balls, bumps, lands, leads) and/or nonintegral heat sinks.

Note 3: The maximum component temperature reached during reflow depends on package thickness and volume. The use of convection reflow processes reduces the thermal gradients between packages. However, thermal gradients due to differences in thermal mass of SMD packages may still exist.

Note 4: Components intended for use in a "lead-free" assembly process shall be evaluated using the "lead free" classification temperatures and profiles defined in Tables 4-1, 4.2 and 5-2 whether or not lead free.



ENGINEERING PRODUCT SPECIFICATION

DATE ISSUED: 12/07/2011

CCS-11005

Page 10 of 10

SUBJECT / TITLE :

UNIVERSAL CONTACT Z SERIES

9 Packing & SMT

Packing: Parts are packed in carrier and reel. The width of carrier tape is 12mm and the diameter of reel is 300mm which are according to the standard EIA-481. For packing quantity see table below.

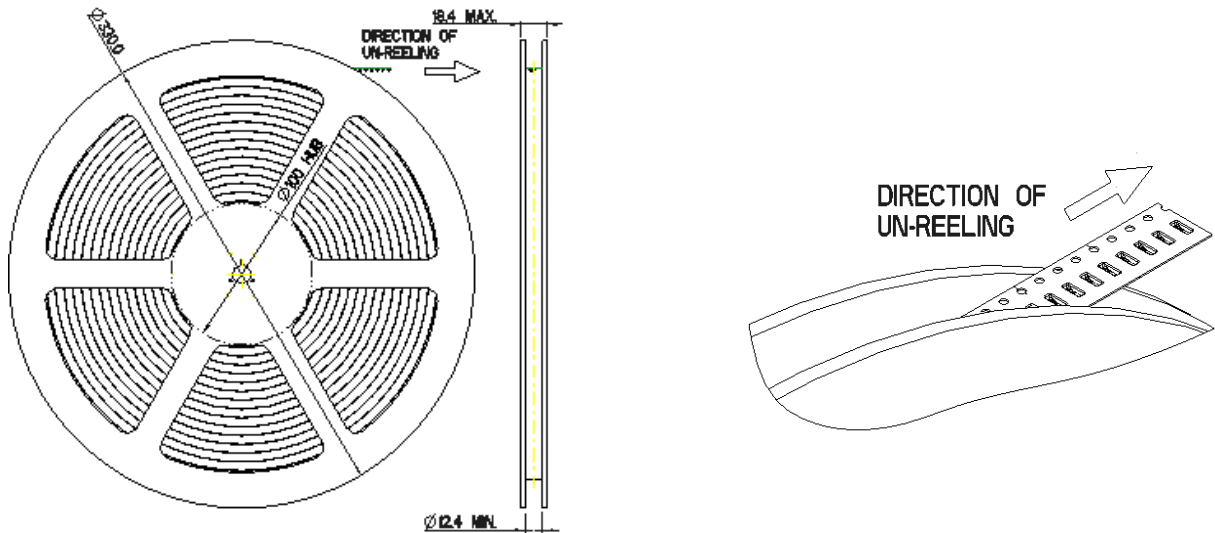

Height	P/N	MPQ (pcs)-Per reel	MOQ (pcs)-Per carton
1.3mm	120220-0310	9500	114000
1.6mm	120220-0331	6800	81600
1.8mm	120220-0311	6800	81600
2.5mm	120220-0312	6000	72000
3.0mm	120220-0313	4200	50400
3.5mm	120220-0314	3600	43200
4.0mm	120220-0315	3200	38400

For further information on pick and place methods and advice when using Universal Contact please refer to ITT Application note APN-11002.